

μPG2413T6Z

Data Sheet

GaAs Integrated Circuit
 SP3T Switch for Bluetooth™ and 802.11b/g

R09DS0001EJ0100
 Rev.1.00
 May 20, 2010

DESCRIPTION

The μPG2413T6Z is a GaAs MMIC SP3T switch which was developed for Bluetooth, wireless LAN. This device can operate at frequencies from 0.5 to 3.0 GHz, with low insertion loss. This device is housed in a 8-pin plastic TSON (Thin Small Out-line Flat Non-leaded) package and is suitable for high-density surface mounting.

FEATURES

- Switch Control voltage : $V_{cont(H)} = 3.0\text{ V TYP.}, V_{cont(L)} = 0\text{ V TYP.}$
- Low insertion loss : $L_{ins} = 0.35\text{ dB TYP. @ } f = 1.0\text{ GHz}$
 : $L_{ins} = 0.45\text{ dB TYP. @ } f = 2.0\text{ GHz}$
 : $L_{ins} = 0.50\text{ dB TYP. @ } f = 2.5\text{ GHz}$
- High isolation : $ISL = 26\text{ dB TYP. @ } f = 1.0\text{ GHz}$
 : $ISL = 20\text{ dB TYP. @ } f = 2.0\text{ GHz}$
 : $ISL = 18\text{ dB TYP. @ } f = 2.5\text{ GHz}$
- Handling power : $P_{in(0.1\text{ dB})} = +28.0\text{ dBm TYP. @ } f = 2.5\text{ GHz}, V_{cont(H)} = 3.0\text{ V}, V_{cont(L)} = 0\text{ V}$
- High-density surface mounting : 8-pin plastic TSON package (1.5 × 1.5 × 0.37 mm)

APPLICATIONS

- Bluetooth and IEEE802.11b/g etc.

ORDERING INFORMATION

Part Number	Order Number	Package	Marking	Supplying Form
μPG2413T6Z-E2	μPG2413T6Z-E2-A	8-pin plastic TSON (Pb-Free)	G6F	<ul style="list-style-type: none"> • Embossed tape 8 mm wide • Pin 1, 8 face the perforation side of the tape • Qty 3 kpcs/reel

Remark To order evaluation samples, please contact your nearby sales office.
 Part number for sample order: μPG2413T6Z-A

CAUTION

Although this device is designed to be as robust as possible, ESD (Electrostatic Discharge) can damage this device. This device must be protected at all times from ESD. Static charges may easily produce potentials of several kilovolts on the human body or equipment, which can discharge without detection. Industry-standard ESD precautions must be employed at all times.

PIN CONNECTIONS AND INTERNAL BLOCK DIAGRAM

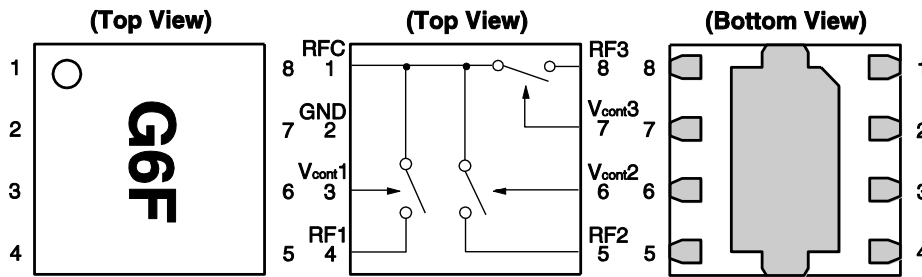

Pin No.	Pin Name
1	RFC
2	GND
3	V _{cont1}
4	RF1
5	RF2
6	V _{cont2}
7	V _{cont3}
8	RF3

Remark Exposed pad : GND

TRUTH TABLE

V _{cont1}	V _{cont2}	V _{cont3}	RFC–RF1	RFC–RF2	RFC–RF3
High	Low	Low	ON	OFF	OFF
Low	High	Low	OFF	ON	OFF
Low	Low	High	OFF	OFF	ON

ABSOLUTE MAXIMUM RATINGS (T_A = +25°C, unless otherwise specified)

Parameter	Symbol	Ratings	Unit
Switch Control Voltage	V _{cont}	+6.0 ^{Note}	V
Input Power (V _{cont (H)} = 1.8 V)	P _{in}	+26	dBm
Input Power (V _{cont (H)} = 2.3 V)	P _{in}	+28	dBm
Input Power (V _{cont (H)} = 3.0 V)	P _{in}	+32	dBm
Input Power (V _{cont (H)} = 3.6 V)	P _{in}	+34	dBm
Operating Ambient Temperature	T _A	–45 to +85	°C
Storage Temperature	T _{stg}	–55 to +150	°C

Note: |V_{cont (H)} – V_{cont (L)}| ≤ 6.0 V

RECOMMENDED OPERATING RANGE (T_A = +25°C)

Parameter	Symbol	MIN.	TYP.	MAX.	Unit
Operating Frequency	f	0.5	–	3.0	GHz
Switch Control Voltage (H)	V _{cont (H)}	1.8	3.0	3.6	V
Switch Control Voltage (L)	V _{cont (L)}	–0.2	0	0.2	V
Control Voltage Difference (H)	ΔV _{cont (H)} Note1	–0.1	0	0.1	V
Control Voltage Difference (L)	ΔV _{cont (L)} Note2	–0.1	0	0.1	V

Notes: 1. ΔV_{cont (H)} is a difference between the maximum and the minimum control voltages among V_{cont1 (H)}, V_{cont2 (H)} and V_{cont3 (H)}.

2. ΔV_{cont (L)} is a difference between the maximum and the minimum control voltages among V_{cont1 (L)}, V_{cont2 (L)} and V_{cont3 (L)}.

ELECTRICAL CHARACTERISTICS 1

($T_A = +25^\circ\text{C}$, $V_{\text{cont (H)}} = 3.0\text{ V}$, $V_{\text{cont (L)}} = 0\text{ V}$, $Z_O = 50\ \Omega$, DC blocking capacitors = 56 pF, unless otherwise specified)

Parameter	Symbol	Pass	Test Conditions	MIN.	TYP.	MAX.	Unit
Insertion Loss	L_{ins}	RFC to RF1, 2, 3	f = 0.5 to 1.0 GHz	–	0.35	0.60	dB
			f = 1.0 to 2.0 GHz	–	0.45	0.70	dB
			f = 2.0 to 2.5 GHz	–	0.50	0.75	dB
			f = 2.5 to 3.0 GHz	–	0.60	–	dB
Isolation	ISL	RFC to RF1, 2, 3 (OFF)	f = 0.5 to 1.0 GHz	23	26	–	dB
			f = 1.0 to 2.0 GHz	17	20	–	dB
			f = 2.0 to 2.5 GHz	15	18	–	dB
			f = 2.5 to 3.0 GHz	–	16	–	dB
Return Loss (RFC)	RL_C		f = 0.5 to 3.0 GHz	15	20	–	dB
Return Loss (RF1, 2, 3)	$RL_{1, 2, 3}$		f = 0.5 to 3.0 GHz	15	20	–	dB
0.1 dB Loss Compression Input Power <small>Note 1</small>	$P_{\text{in (0.1 dB)}}$	RFC to RF1, 2, 3	f = 2.5 GHz	+25.0	+28.0	–	dBm
1 dB Loss Compression Input Power <small>Note 2</small>	$P_{\text{in (1 dB)}}$	RFC to RF1, 2, 3	f = 2.5 GHz, $V_{\text{cont (H)}} = 2.3\text{ V}$	–	+27.0	–	dBm
			f = 2.5 GHz, $V_{\text{cont (H)}} = 3.0\text{ V}$	–	+31.0	–	dBm
			f = 2.5 GHz, $V_{\text{cont (H)}} = 3.6\text{ V}$	–	+33.0	–	dBm
2nd Harmonics	2f0		f = 2.5 GHz, $P_{\text{in}} = 23\text{ dBm}$	–	75	–	dBc
3rd Harmonics	3f0		f = 2.5 GHz, $P_{\text{in}} = 23\text{ dBm}$	–	75	–	dBc
Switch Control Current	I_{cont}		No RF input	–	0.1	5.0	μA
Switch Control Speed	t_{sw}		50% CTL to 90/10% RF	–	50	–	ns

Notes: 1. $P_{\text{in (0.1 dB)}}$ is the measured input power level when the insertion loss increases 0.1 dB more than that of the linear range.

2. $P_{\text{in (1 dB)}}$ is the measured input power level when the insertion loss increases 1 dB more than that of the linear range.

CAUTION

It is necessary to use DC blocking capacitors with this device.

ELECTRICAL CHARACTERISTICS 2

($T_A = +25^\circ\text{C}$, $V_{\text{cont (H)}} = 1.8\text{ V}$, $V_{\text{cont (L)}} = 0\text{ V}$, $Z_O = 50\ \Omega$, DC blocking capacitors = 56 pF, unless otherwise specified)

Parameter	Symbol	Pass	Test Conditions	MIN.	TYP.	MAX.	Unit
Insertion Loss	L_{ins}	RFC to RF1, 2, 3	f = 0.5 to 1.0 GHz	–	0.35	0.65	dB
			f = 1.0 to 2.0 GHz	–	0.45	0.75	dB
			f = 2.0 to 2.5 GHz	–	0.50	0.80	dB
			f = 2.5 to 3.0 GHz	–	0.65	–	dB
Isolation	ISL	RFC to RF1, 2, 3 (OFF)	f = 0.5 to 1.0 GHz	22.5	25.5	–	dB
			f = 1.0 to 2.0 GHz	16.5	19.5	–	dB
			f = 2.0 to 2.5 GHz	14.5	17.5	–	dB
			f = 2.5 to 3.0 GHz	–	15.5	–	dB
Return Loss (RFC)	RL_C		f = 0.5 to 3.0 GHz	15	20	–	dB
Return Loss (RF1, 2, 3)	$RL_{1, 2, 3}$		f = 0.5 to 3.0 GHz	15	20	–	dB
0.1 dB Loss Compression Input Power <small>Note 1</small>	$P_{\text{in (0.1 dB)}}$	RFC to RF1, 2, 3	f = 2.5 GHz	+19.0	+22.0	–	dBm
1 dB Loss Compression Input Power <small>Note 2</small>	$P_{\text{in (1 dB)}}$	RFC to RF1, 2, 3	f = 2.5 GHz	+21.0	+25.0	–	dBm
2nd Harmonics	2f0		f = 2.5 GHz, $P_{\text{in}} = 17\text{ dBm}$	–	75	–	dBc
3rd Harmonics	3f0		f = 2.5 GHz, $P_{\text{in}} = 17\text{ dBm}$	–	75	–	dBc
Switch Control Current	I_{cont}		No RF input	–	0.1	5.0	μA
Switch Control Speed	t_{sw}		50% CTL to 90/10% RF	–	50	–	ns

Notes: 1. $P_{\text{in (0.1 dB)}}$ is the measured input power level when the insertion loss increases 0.1 dB more than that of the linear range.

2. $P_{\text{in (1 dB)}}$ is the measured input power level when the insertion loss increases 1 dB more than that of the linear range.

CAUTION

It is necessary to use DC blocking capacitors with this device.

EVALUATION CIRCUIT

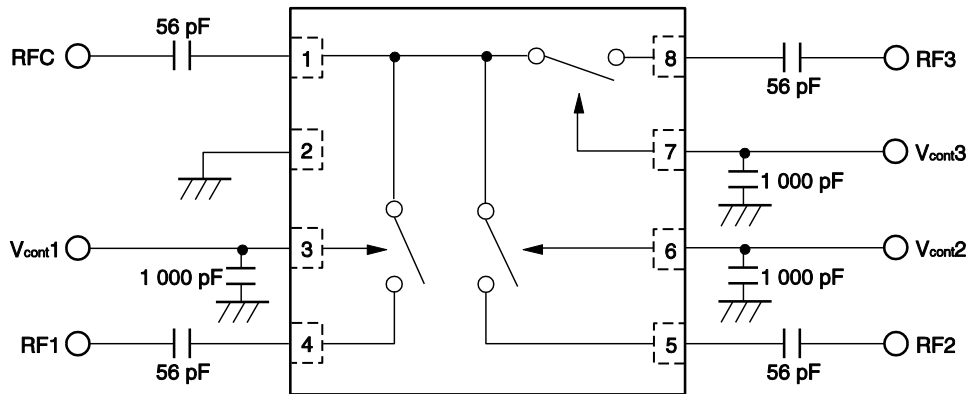

The application circuits and their parameters are for reference only and are not intended for use in actual design-ins.

APPLICATION INFORMATION

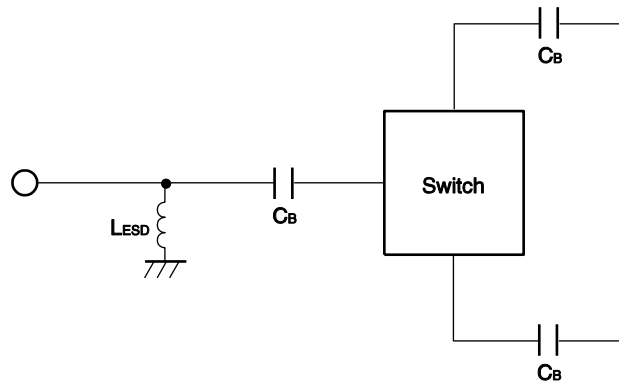

- C_B are DC blocking capacitors external to the device.
A value of 56 pF is sufficient for operation from 500 MHz to 2.5 GHz bands.
The value may be tailored to provide specific electrical responses.
- The RF ground connections should be kept as short as possible and connected to directly to a good RF ground for best performance.
- L_{ESD} provides a means to increase the ESD protection on a specific RF port, typically the port attached to the antenna.

TYPICAL CHARACTERISTICS

($T_A = +25^\circ\text{C}$, DC blocking capacitors = 56 pF, unless otherwise specified)

**RFC-RF1/RF2/RF3
INSERTION LOSS vs. FREQUENCY**

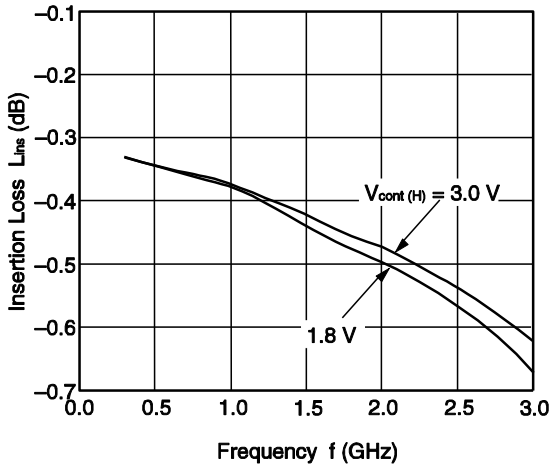

**RFC-RF1/RF2/RF3
ISOLATION vs. FREQUENCY**

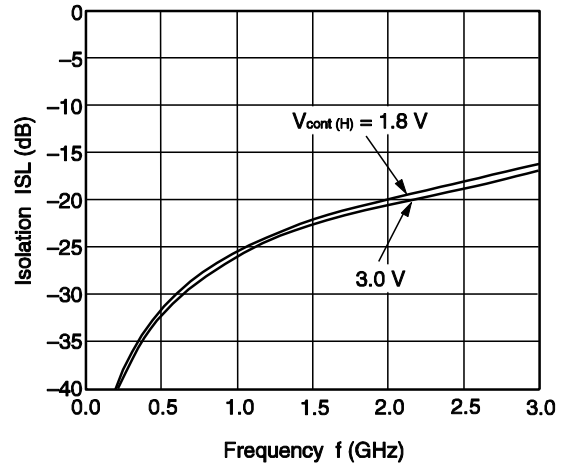

RETURN LOSS (RFC) vs. FREQUENCY

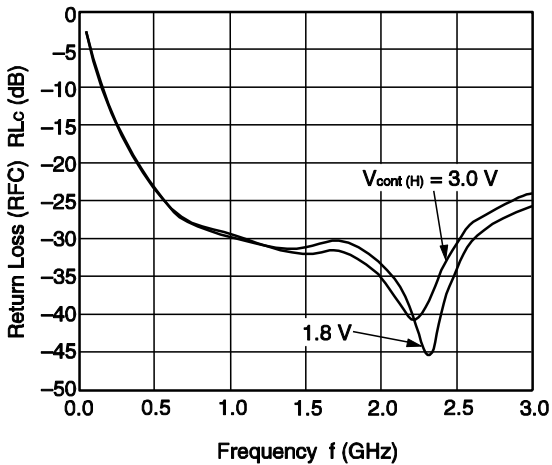

RETURN LOSS (RF1, 2, 3) vs. FREQUENCY

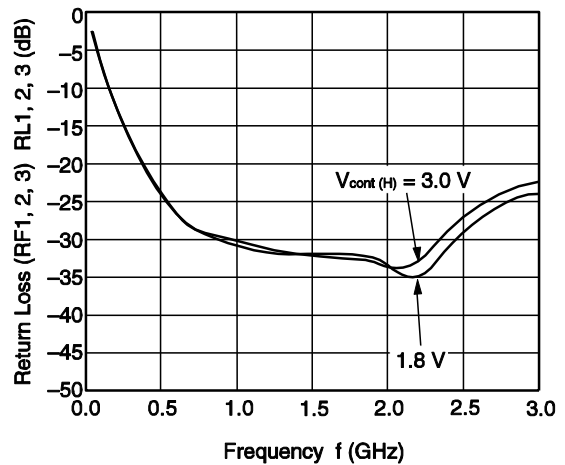

**RFC-RF1/RF2/RF3 INSERTION LOSS
vs. SWITCH CONTROL VOLTAGE (H)**

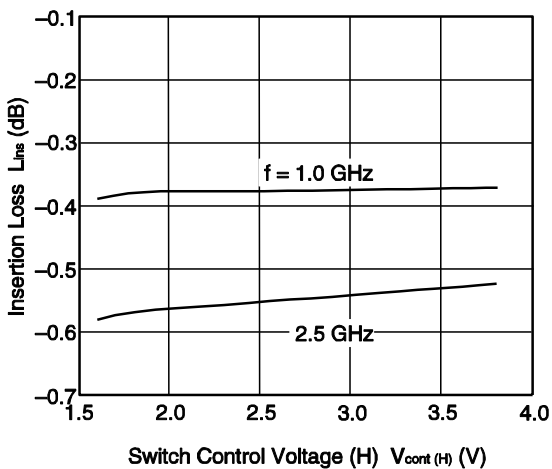

**RFC-RF1/RF2/RF3 ISOLATION vs.
SWITCH CONTROL VOLTAGE (H)**

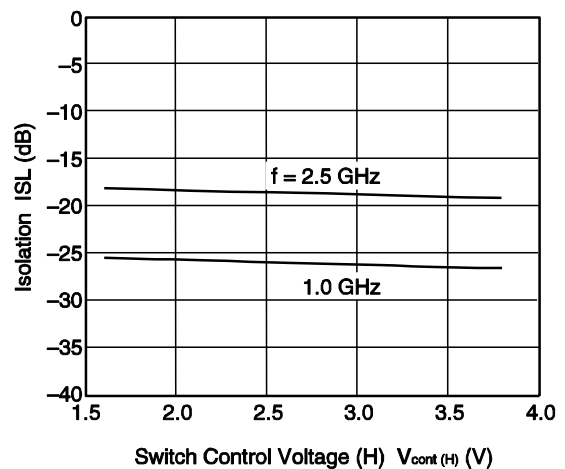

Remark The graphs indicate nominal characteristics.

**RETURN LOSS (RFC)
vs. SWITCH CONTROL VOLTAGE (H)**

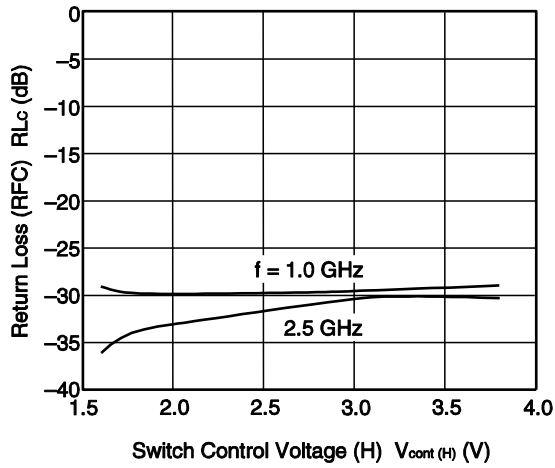

**RETURN LOSS (RF1, 2, 3)
vs. SWITCH CONTROL VOLTAGE (H)**

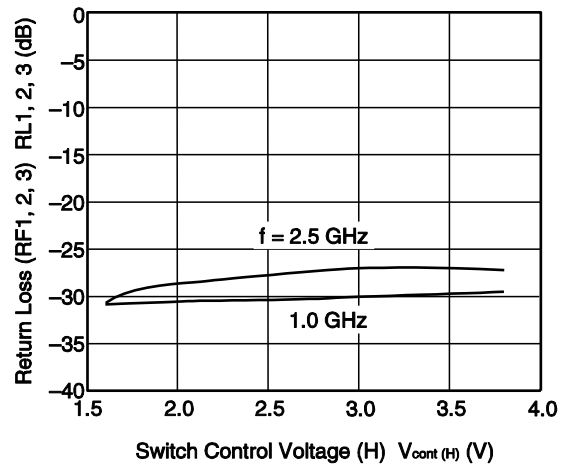

**RFC-RF1/RF2/RF3 INSERTION LOSS,
Icont vs. INPUT POWER**

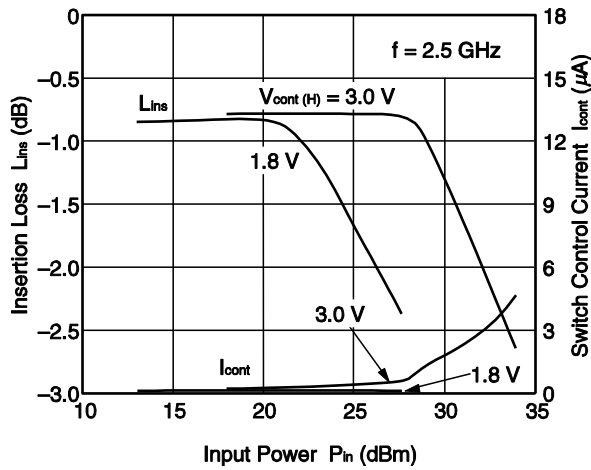

**RFC-RF1/RF2/RF3 Pin (1 dB), Pin (0.1 dB) vs.
SWITCH CONTROL VOLTAGE (H)**

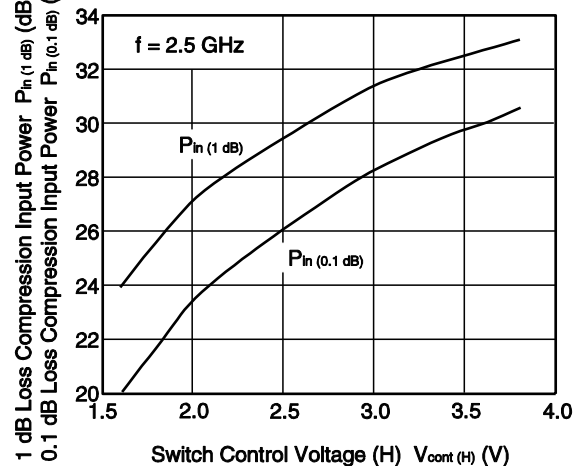

Remark The graphs indicate nominal characteristics.

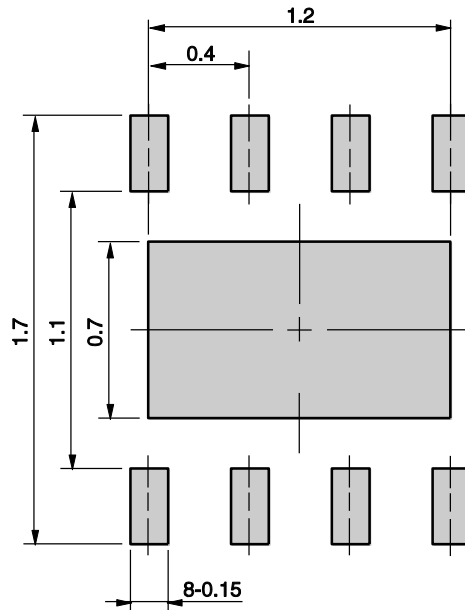
MOUNTING PAD LAYOUT DIMENSIONS**8-PIN PLASTIC TSON (UNIT: mm)**

Remark The mounting pad layout in this document is for reference only.
When designing PCB, please consider workability of mounting, solder joint reliability, prevention of solder bridge and so on, in order to optimize the design.

μPG2413T6Z

PACKAGE DIMENSIONS

8-PIN PLASTIC TSON (UNIT: mm)

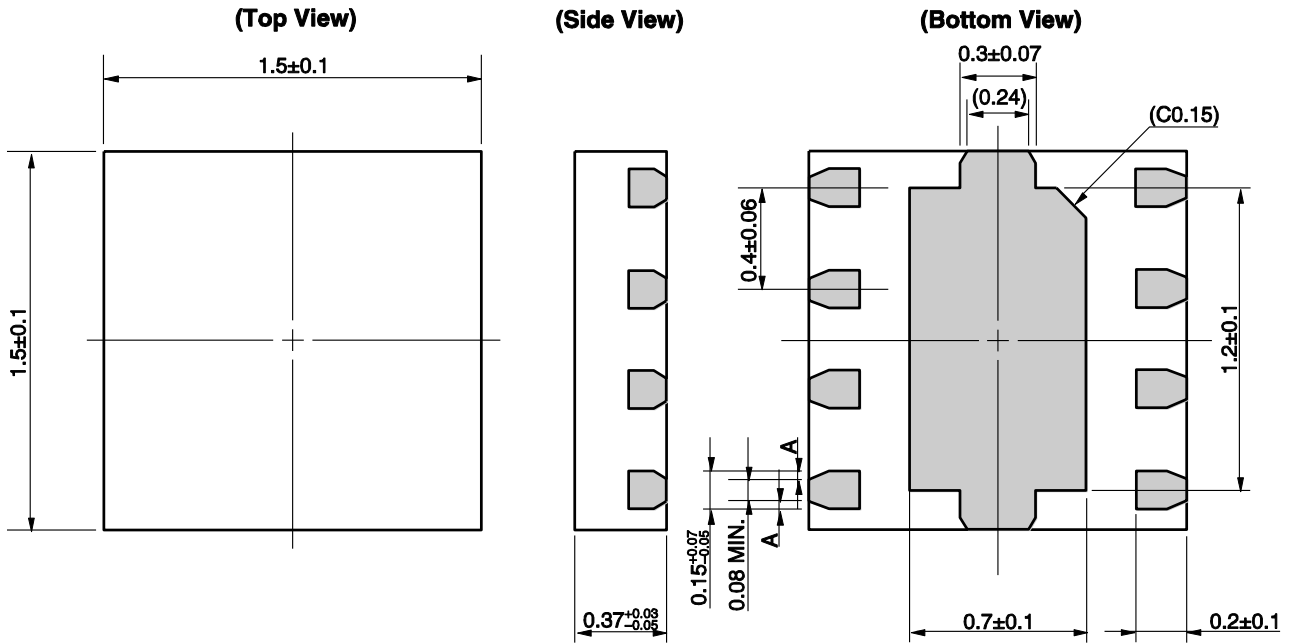

Remark $A > 0$
 (): Reference value

RECOMMENDED SOLDERING CONDITIONS

This product should be soldered and mounted under the following recommended conditions. For soldering methods and conditions other than those recommended below, contact your nearby sales office.

Soldering Method	Soldering Conditions	Condition Symbol
Infrared Reflow	Peak temperature (package surface temperature) : 260°C or below Time at peak temperature : 10 seconds or less Time at temperature of 220°C or higher : 60 seconds or less Preheating time at 120 to 180°C : 120±30 seconds Maximum number of reflow processes : 3 times Maximum chlorine content of rosin flux (% mass) : 0.2%(Wt.) or below	IR260
Partial Heating	Peak temperature (terminal temperature) : 350°C or below Soldering time (per side of device) : 3 seconds or less Maximum chlorine content of rosin flux (% mass) : 0.2%(Wt.) or below	HS350

CAUTION

Do not use different soldering methods together (except for partial heating).

Caution	GaAs Products	<p>This product uses gallium arsenide (GaAs). GaAs vapor and powder are hazardous to human health if inhaled or ingested, so please observe the following points.</p> <ul style="list-style-type: none">• Follow related laws and ordinances when disposing of the product. If there are no applicable laws and/or ordinances, dispose of the product as recommended below.<ol style="list-style-type: none">1. Commission a disposal company able to (with a license to) collect, transport and dispose of materials that contain arsenic and other such industrial waste materials.2. Exclude the product from general industrial waste and household garbage, and ensure that the product is controlled (as industrial waste subject to special control) up until final disposal.• Do not burn, destroy, cut, crush, or chemically dissolve the product.• Do not lick the product or in any way allow it to enter the mouth.
----------------	---------------	--

Revision History	μPG2413T6Z Data Sheet
-------------------------	------------------------------

Rev.	Date	Description	
		Page	Summary
1.00	May 20, 2010	–	First edition issued

Bluetooth is a trademark owned by Bluetooth SIG, Inc., U.S.A.

All trademarks and registered trademarks are the property of their respective owners.

Mouser Electronics

Authorized Distributor

Click to View Pricing, Inventory, Delivery & Lifecycle Information:

[CEL:](#)

[UPG2413T6Z-A](#) [UPG2413T6Z-E2-A](#)