

SF2419E

495 MHz SAW Filter

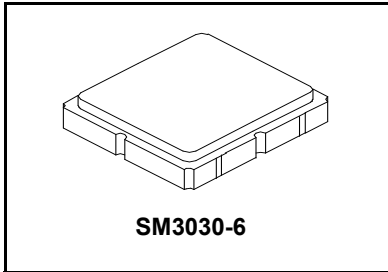

• **Surface Mount 3.0 x 3.0 mm Package**

Absolute Maximum Ratings

Rating	Value	Units
Input Power Level	10	dBm
DC Voltage	3	V
Operable Temperature Range	-45 to +125	°C
Specification Temperature Range	-40 to +85	°C
Storage Temperature Range in Tape and Reel	-40 to +85	°C

Electrical Characteristics

Characteristic	Sym	Notes	Min	Typ	Max	Units
Center Frequency	f_c			495		MHz
Insertion Loss (490 to 500 MHz)	IL			1.9	3.5	dB
Amplitude Ripple (490 to 500 MHz)				0.6	1.5	
VSWR (490 to 500 MHz)				1.3	2.3	
Attenuation, Referenced from 0 dB						dB
Fc-45.8 to Fc-39.8 MHz			50	58		
Fc+39.8 to Fc+45.8 MHz			43	49.5		
Temperature Coefficient of Frequency				-36		ppm/°C
Case Style	SM3030-6 3.0 x 3.0 mm Nominal Footprint					
Lid Symbolization (Y=year, WW=week, S=shift) dot=pin 1 indicator	7Z, YWWS					
Standard Reel Quantity	Reel Size 7 Inch					500 Pieces/Reel
	Reel Size 13 Inch					3000 Pieces/Reel

Electrical Connections

Connection	Terminals
Input	2
Output	5
Case Ground	All others

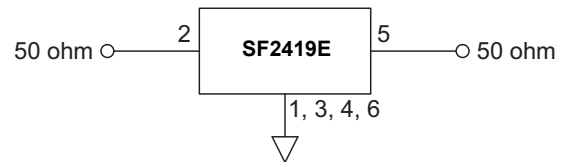

CAUTION: Electrostatic Sensitive Device. Observe precautions for handling.

NOTES:

- Unless noted otherwise, all specifications apply over the operating temperature range with filter soldered to the specified demonstration board with impedance matching to 50 Ω and measured with 50 Ω network analyzer.
- Unless noted otherwise, all frequency specifications are referenced to the nominal center frequency, f_c .
- Rejection is measured as attenuation below the minimum IL point in the passband. Rejection in final user application is dependent on PCB layout and external impedance matching design. See Application Note No. 42 for details.
- "LRIP" or "L" after the part number indicates "low rate initial production" and "ENG" or "E" indicates "engineering prototypes."
- The design, manufacturing process, and specifications of this filter are subject to change.
- Either Port 1 or Port 2 may be used for either input or output in the design. However, impedances and impedance matching may vary between Port 1 and Port 2, so that the filter must always be installed in one direction per the circuit design.
- US and international patents may apply.
- Murata, stylized Murata logo, and Murata N.A., Inc. are registered trademarks of Murata Manufacturing Co., Ltd.

Frequency Characteristics:

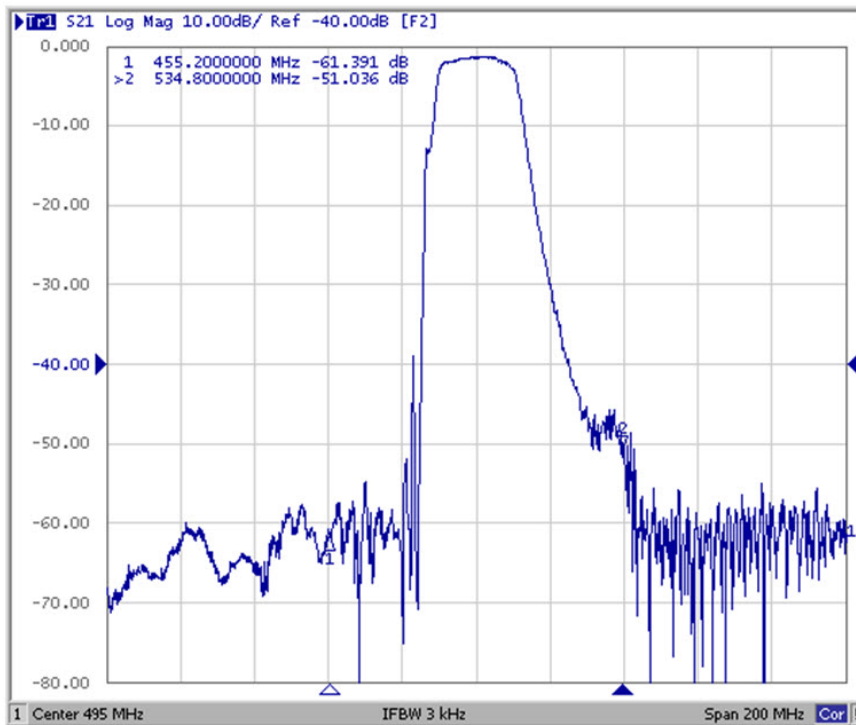
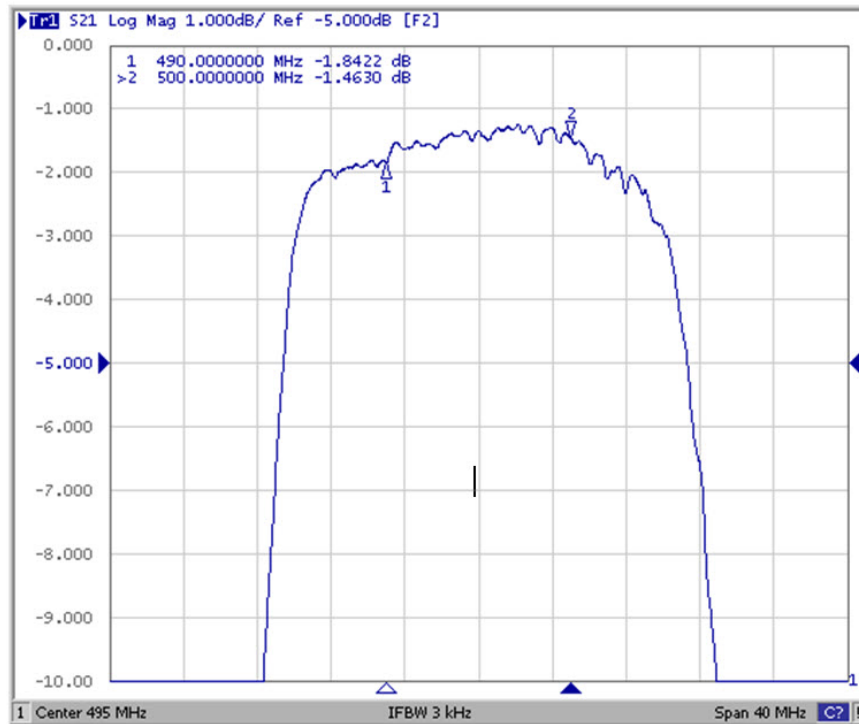

Reflection Functions:

S11

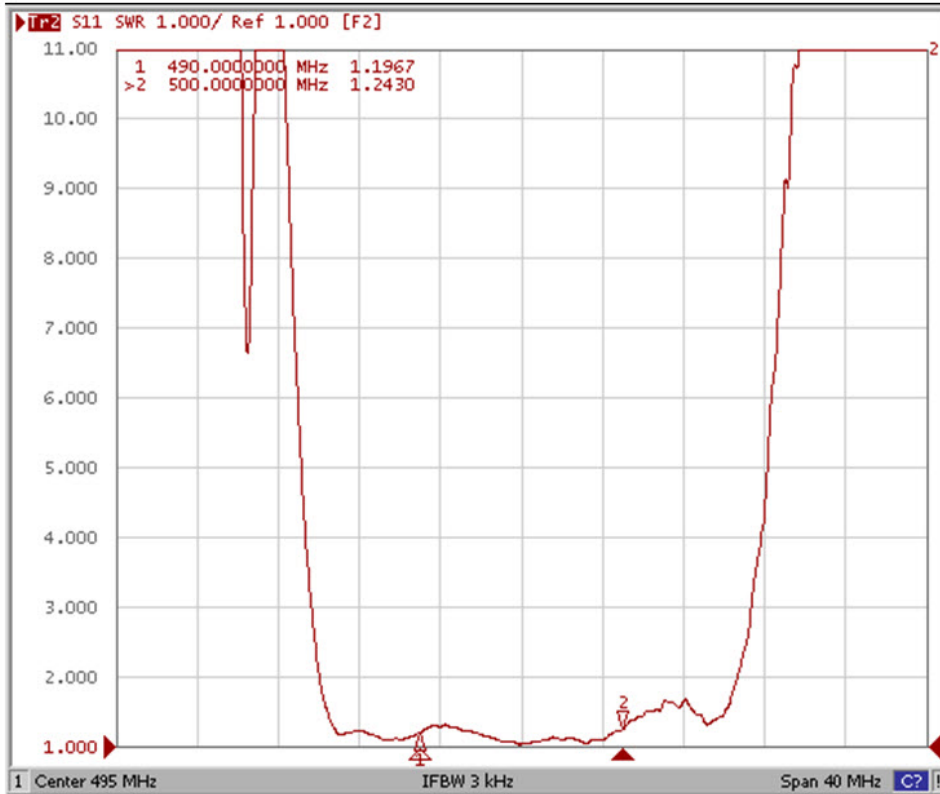

S22

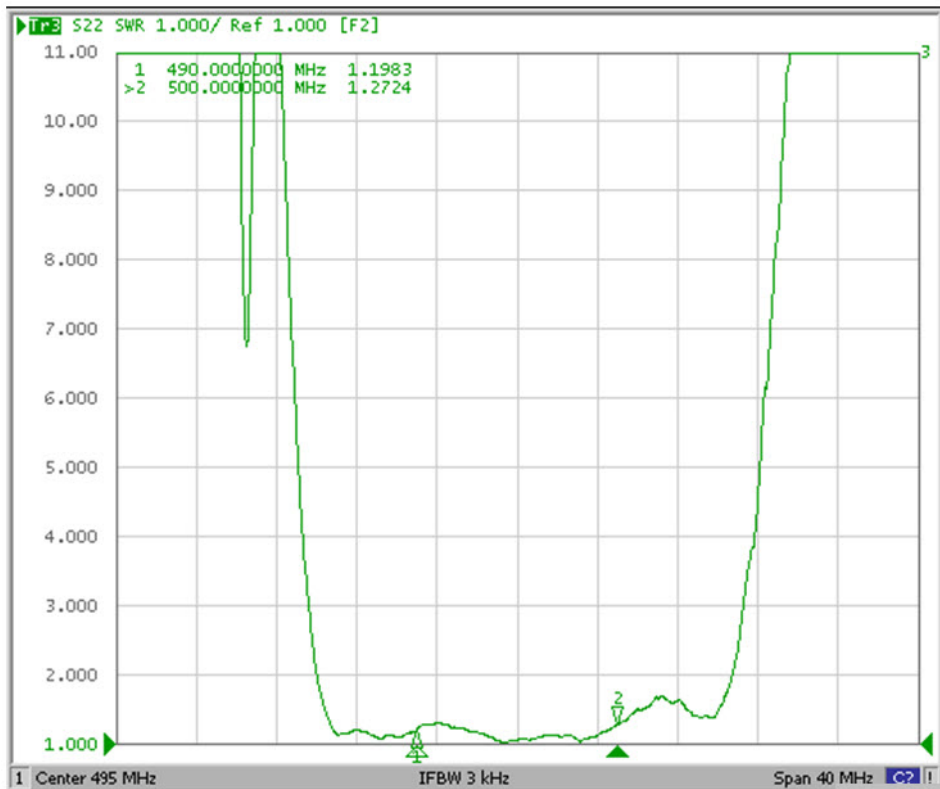

SM3030-6 Case

6-Terminal Ceramic Surface-Mount Case 3.0 X 3.0 mm Nominal Footprint

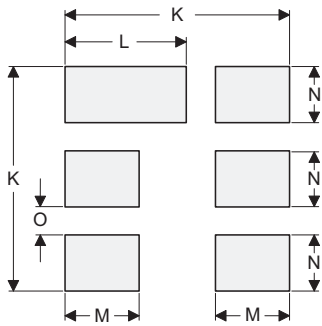
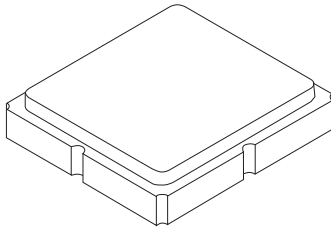

PCB Footprint Top View

Case and PCB Footprint Dimensions

Dimension	mm			Inches		
	Min	Nom	Max	Min	Nom	Max
A	2.99	3.00	3.01	0.117	0.118	0.118
B	2.99	3.00	3.01	0.117	0.118	0.118
C	-	-	1.40	-	-	0.055
D	-	-	1.00	-	-	0.039
E	-	2.80	-	-	0.110	-
F	-	1.60	-	-	0.063	-
G	-	0.85	-	-	0.033	-
H	-	1.50	-	-	0.059	-
I	-	0.60	-	-	0.024	-
J	-	1.30	-	-	0.051	-
K	-	3.20	-	-	0.126	-
L	-	1.70	-	-	0.067	-
M	-	1.05	-	-	0.041	-
N	-	0.81	-	-	0.032	-
O	-	0.38	-	-	0.015	-

Case Materials

Materials	
Solder Pad Plating	0.3 to 1.0 μm Gold over 1.27 to 8.89 μm Nickel
Lid Plating	2.0 to 3.0 μm Nickel
Body	Al_2O_3 Ceramic
Pb Free	

TOP VIEW

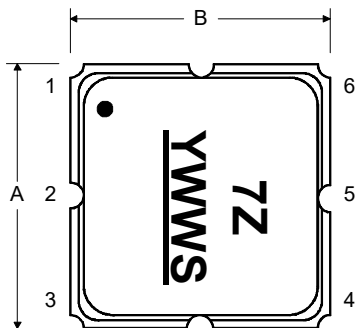

BOTTOM VIEW

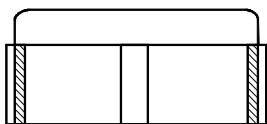
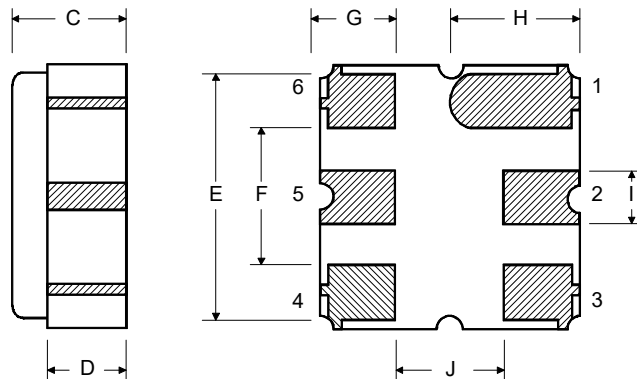

Tape and Reel Specifications

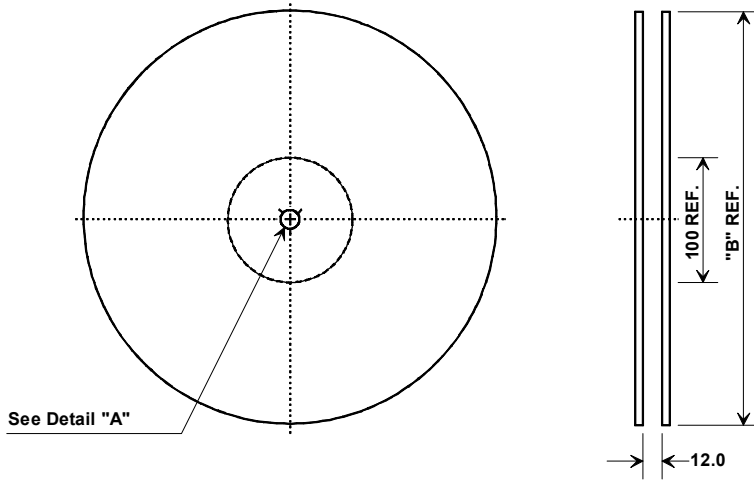

"B"		Quantity Per Reel
Inches	millimeters	
7	178	500
13	330	3000

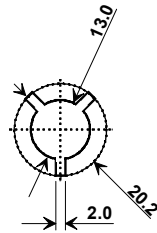

COMPONENT ORIENTATION and DIMENSIONS

Carrier Tape Dimensions	
Ao	3.35 mm
Bo	3.35 mm
Ko	1.40 mm
Pitch	8.0 mm
W	12.0 mm

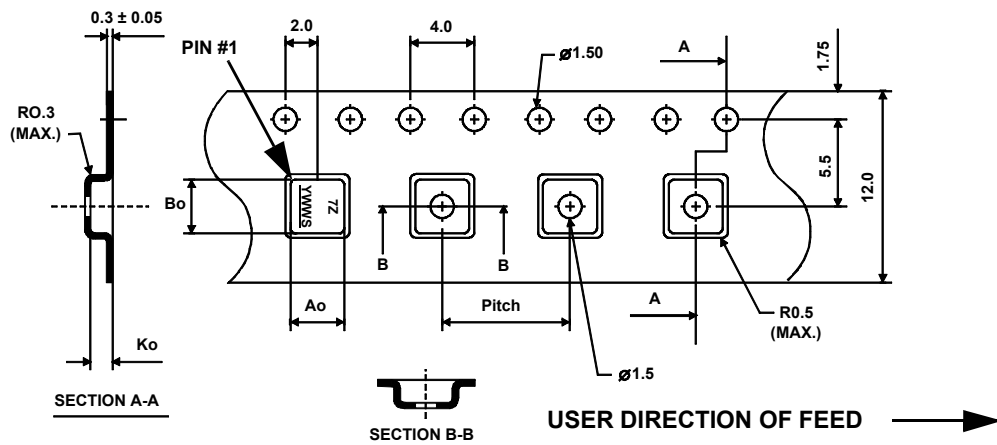

Mouser Electronics

Authorized Distributor

Click to View Pricing, Inventory, Delivery & Lifecycle Information:

[Murata:](#)

[SF2419E](#)