

SF1224E-1

**2332.5 MHz
SAW Filter**

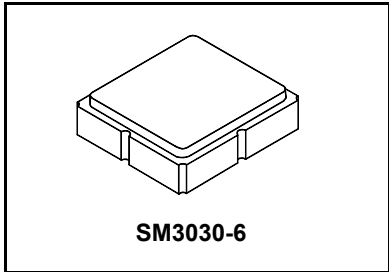

- RF SAW Filter, 2332.5 MHz, 25.6 MHz Bandwidth
- 3.0 x 3.0 x 1.4 mm Surface-mount Case
- Input/Output Impedance 50Ω/50Ω
- Meets AEC-Q200 Standard
- Complies with Directive 2002/95/EC (RoHS)



Absolute Maximum Ratings

Rating	Value	Units
Incident Power in Passband	+15	dBm
Incident Power Out of Band	+27	dBm
DC Voltage on any Non-ground Terminal	3	VDC
Operating Temperature Range	-40 to +105	°C
Component Storage Temperature Range	-40 to +105	°C
Storage Temperature Range in Tape and Reel	-40 to +85	°C
Maximum Soldering Profile, 5 cycles/10 seconds maximum	265	°C

Electrical Characteristics

Characteristic	Sym	Notes	Min	Typ	Max	Units
Center Frequency	f_C		2332.5			MHz
Maximum Insertion Loss, 2319.4 to 2345.0 MHz	IL			1.5	2.5	dB
Amplitude Ripple, p-p, 2319.4 to 2345.0 MHz				0.7	1.2	
I/O Return Loss, 2319.4 to 2345.0 MHz			10	12		
I/O VSWR, 2319.4 to 2345.0 MHz				1.7:1	2.2:1	
Attenuation (Reference level from 0 dB)						dB
10 to 2224 MHz			30	38		
2453 to 2600 MHz			35	42		
2600 to 3000 MHz			30	35		
3000 to 6000 MHz			15	18		
Terminating Source impedance	Z_S			50		Ω
Terminating Load impedance	Z_L			50		Ω

Single Ended Input / Output, Impedance match	No matching network required for operation at 50 ohms
Case Style	SM3030-6
Lid Symbolization	A65

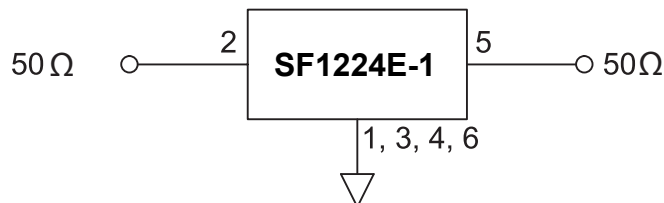

CAUTION: Electrostatic Sensitive Device. Observe precautions for handling.

NOTES:

1. US and international patents may apply.
2. Murata, stylized Murata logo, and Murata N.A., Inc. are registered trademarks of Murata Manufacturing Co., Ltd.

Filter Response Plots

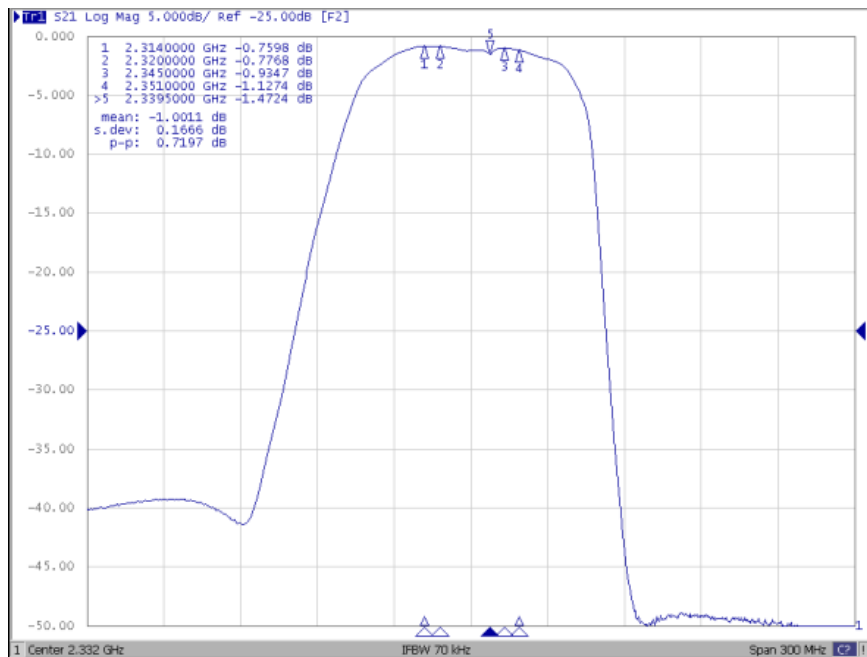
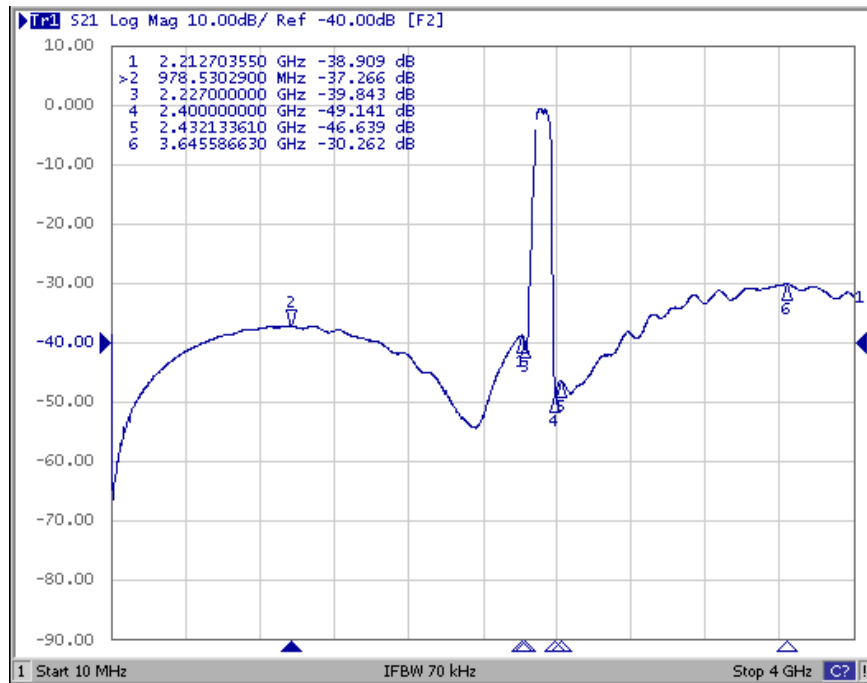

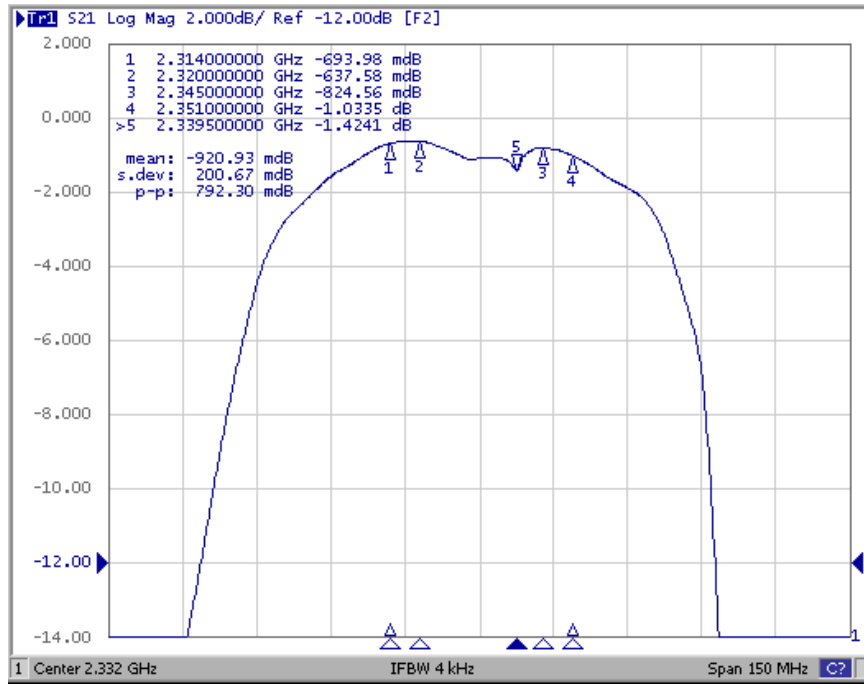

Input/Output VSWR Plots

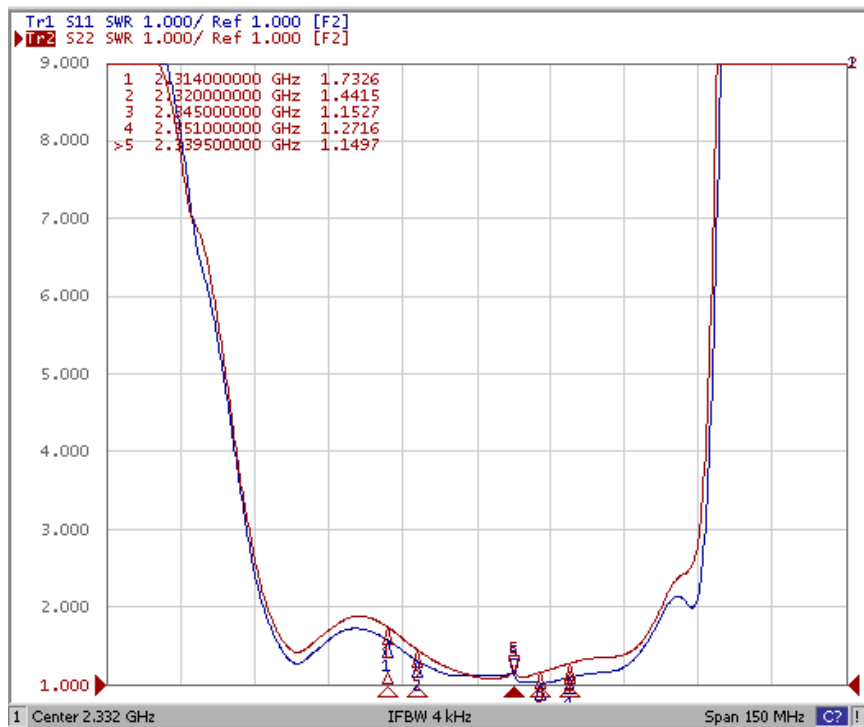

6-Terminal Ceramic Surface-Mount Case 3.0 X 3.0 mm Nominal Footprint

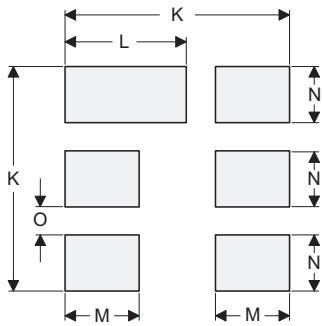
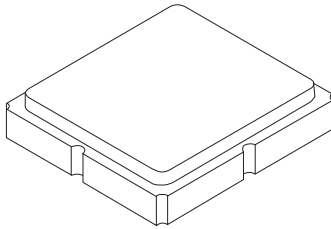

PCB Footprint Top View

Case and PCB Footprint Dimensions

Dimension	mm			Inches		
	Min	Nom	Max	Min	Nom	Max
A	2.87	3.00	3.13	0.113	0.118	0.123
B	2.87	3.00	3.13	0.113	0.118	0.123
C	1.12	1.25	1.38	0.044	0.049	0.054
D	0.77	0.90	1.03	0.030	0.035	0.040
E	2.67	2.80	2.93	0.105	0.110	0.115
F	1.47	1.60	1.73	0.058	0.063	0.068
G	0.72	0.85	0.98	0.028	0.033	0.038
H	1.37	1.50	1.63	0.054	0.059	0.064
I	0.47	0.60	0.73	0.019	0.024	0.029
J	1.17	1.30	1.43	0.046	0.051	0.056
K		3.20			0.126	
L		1.70			0.067	
M		1.05			0.041	
N		0.81			0.032	
O		0.38			0.015	

Case Materials

Materials	
Solder Pad Plating	0.3 to 1.0 μm Gold over 1.27 to 8.89 μm Nickel
Lid Plating	2.0 to 3.0 μm Nickel
Body	Al_2O_3 Ceramic
Pb Free	

TOP VIEW

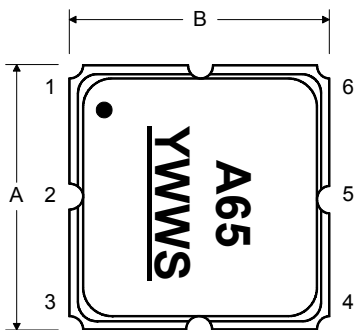

BOTTOM VIEW

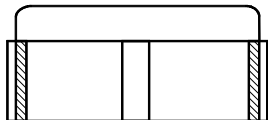
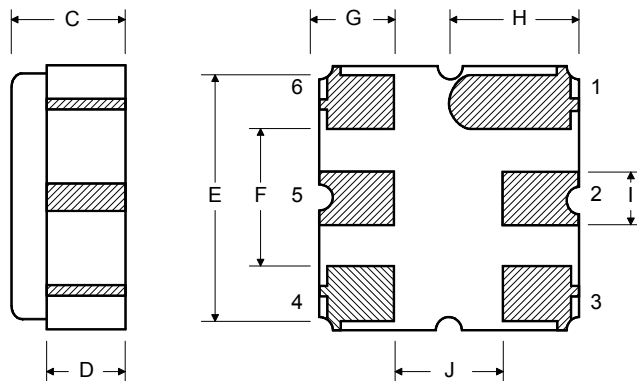

Tape and Reel Specifications

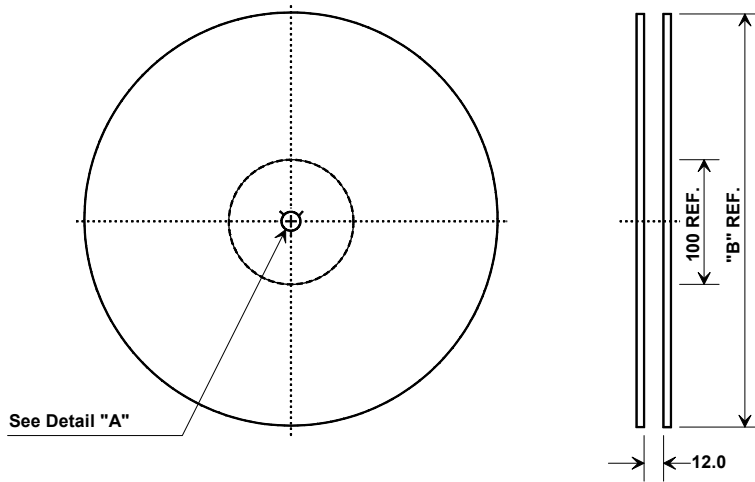

"B"		Quantity Per Reel
Inches	millimeters	
7	178	500
13	330	3000

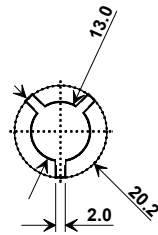

COMPONENT ORIENTATION and DIMENSIONS

Carrier Tape Dimensions	
Ao	3.35 mm
Bo	3.35 mm
Ko	1.40 mm
Pitch	8.0 mm
W	12.0 mm

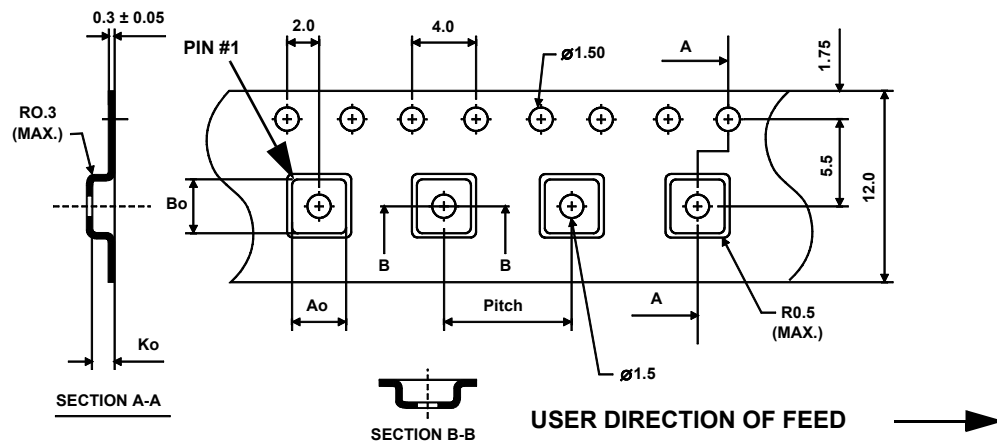

Mouser Electronics

Authorized Distributor

Click to View Pricing, Inventory, Delivery & Lifecycle Information:

[Murata:](#)

[SF1224E-1](#)