

SF1201D

**455.0 MHz
SAW Filter**

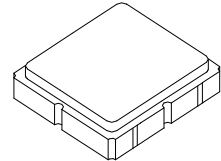

SM3838-6

- CDMA 450 F-Band RF SAW Filter
- 3.8 x 3.8 x 1.4 mm Surface-mount Package
- Complies with Directive 2002/95/EC (RoHS)



Absolute Maximum Ratings

Rating	Value	Units
Maximum Incident Power in Passband	+28	dBm
Maximum DC Voltage Between any Two Terminals	30	VDC
Storage Temperature Range in Tape and Reel	-40 to +85	°C
Suitable for Lead-free Soldering - Maximum Soldering Profile	260°C for 30 s	

Electrical Characteristics

Characteristic	Sym	Notes	Min	Typ	Max	Units
Nominal 1 dB Center Frequency	f_c			455.0		MHz
Passband Insertion Loss, 452.5 to 457.5 MHz	IL	1		1.8	2.8	dB
Passband VSWR, 452.5 to 457.5 MHz				1.2:1	2.0:1	
Rejection Referenced to 0 dB:						
0.3 to 350.0 MHz		1, 2, 3	30	33		dB
350.0 to 445.0 MHz			25	30		
462.5 to 463.1 MHz			40	45		
463.1 to 467.5 MHz			30	45		
467.5 to 2000 MHz			25	30		
Operating Temperature Range	T_A	1	-30		+85	°C
Single-ended Source Impedance	50 ohm					
Single-ended Load Impedance	50 ohm					

Case Style	SM3838-6 3.8 x 3.8 mm Nominal Footprint					
Lid Symbolization (Y=year, WW=week, S=shift) dot=pin 1 indicator	601, YWWS					
Standard Reel Quantity	Reel Size 7 Inch					1000 Pieces/Reel
	Reel Size 13 Inch					3000 Pieces/Reel

Electrical Connections

Connection	Terminals
Port 1	2
Port 2	5
Case Ground	All others

CAUTION: Electrostatic Sensitive Device. Observe precautions for handling.

NOTES:

1. Unless noted otherwise, all specifications apply over the operating temperature range with filter soldered to the specified demonstration board with impedance matching to 50 Ω and measured with 50 Ω network analyzer.
2. Unless noted otherwise, all frequency specifications are referenced to the nominal center frequency, f_c .
3. Rejection is measured as attenuation below the minimum IL point in the passband. Rejection in final user application is dependent on PCB layout and external impedance matching design. See Application Note No. 42 for details.
4. "LRIP" or "L" after the part number indicates "low rate initial production" and "ENG" or "E" indicates "engineering prototypes."
5. The design, manufacturing process, and specifications of this filter are subject to change.
6. Either Port 1 or Port 2 may be used for either input or output in the design. However, impedances and impedance matching may vary between Port 1 and Port 2, so that the filter must always be installed in one direction per the circuit design.
7. US and international patents may apply.
8. Murata, stylized Murata logo, and Murata N.A., Inc. are registered trademarks of Murata Manufacturing Co., Ltd.

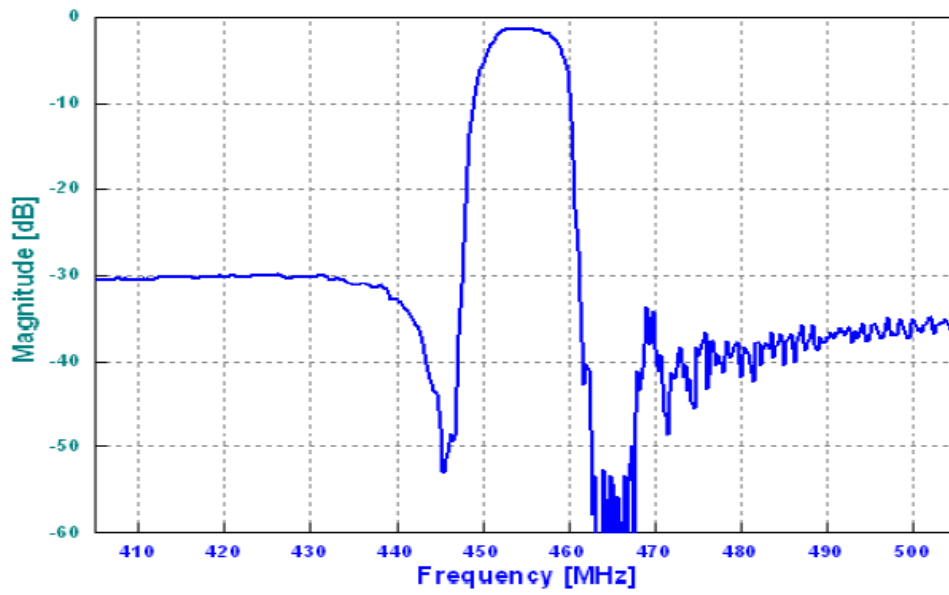

Passband Plot

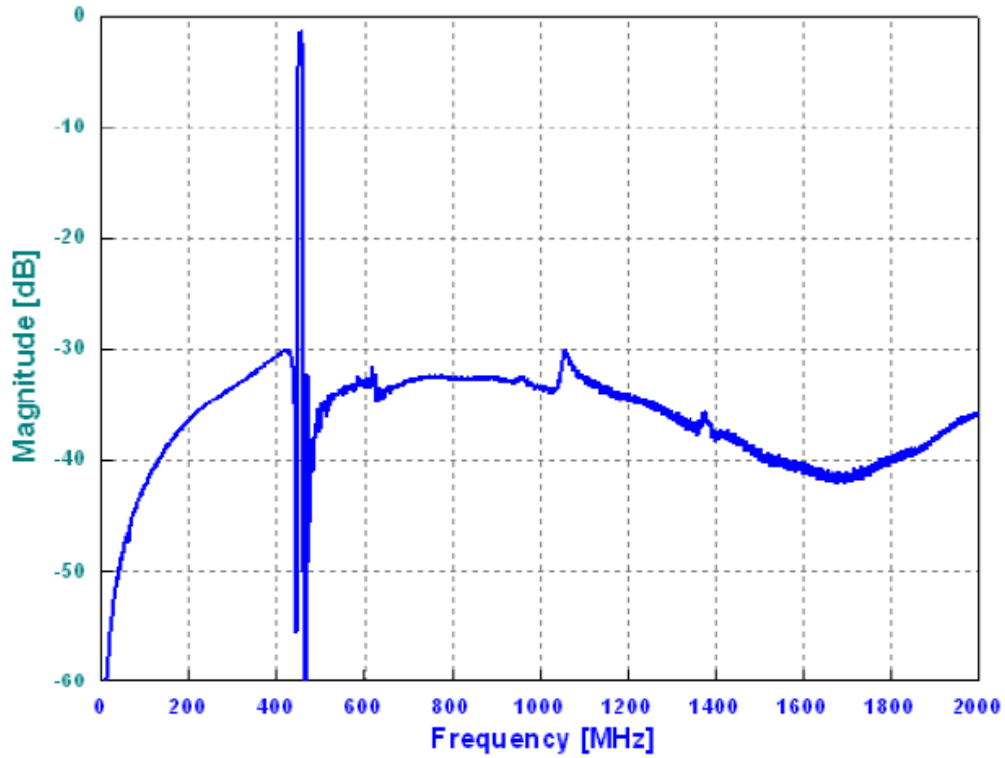

Wideband Plot

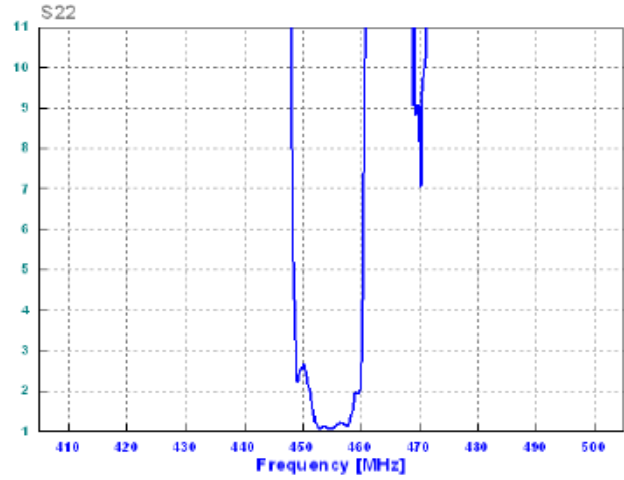
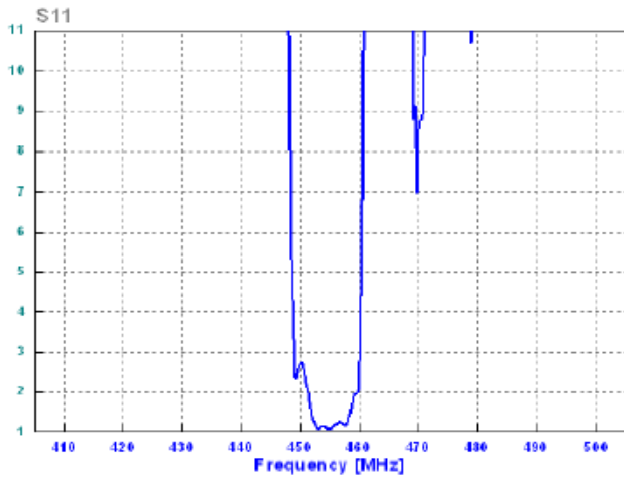

VSWR

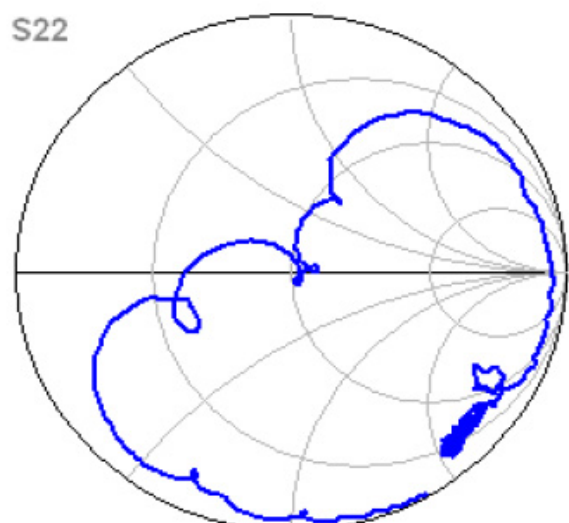
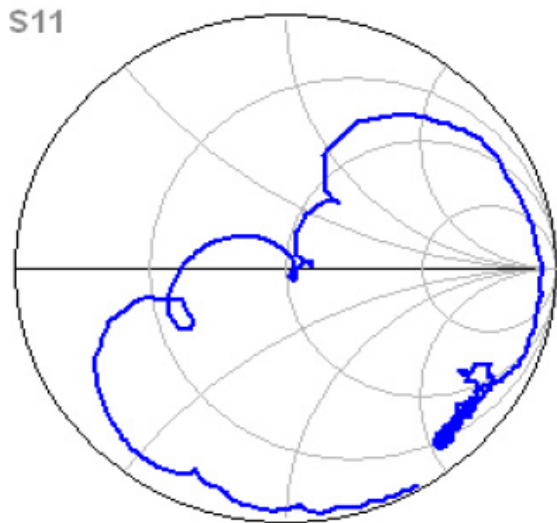

S11 and S22 Plots

SM3838-6 Case

6-Terminal Ceramic Surface-Mount Case

3.8 X 3.8 mm Nominal Footprint

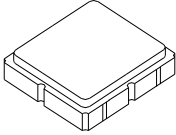

Case Dimensions						
Dimension	mm			Inches		
	Min	Nom	Max	Min	Nom	Max
A	3.60	3.80	4.0	0.14	0.15	0.16
B	3.60	3.80	4.0	0.14	0.15	0.16
C	1.30	1.50	1.70	0.05	0.06	0.067
D	0.95	1.10	1.25	0.037	0.043	0.05
E	2.39	2.54	2.69	0.090	0.10	0.110
G	0.90	1.0	1.10	0.035	0.04	0.043
H	1.90	2.0	2.10	0.75	0.08	0.83
I	0.50	0.6	0.70	0.020	0.024	0.028
J	1.70	1.8	1.90	0.067	0.07	0.075

Electrical Connections		
Connection	Terminals	
Port 1	Single-ended Input	2
Port 2	Single-ended Output	5
	Ground	All others
Single-ended Operation Only		
Dot indicates Pin 1		

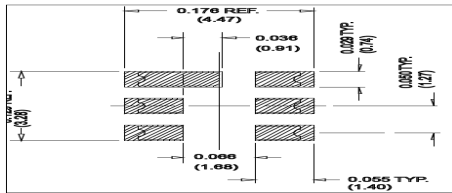

PCB Footprint

Materials	
Solder Pad Plating	0.3 to 1.0 μm Gold over 1.27 to 8.89 μm Nickel
Lid Plating	2.0 to 3.0 μm Nickel
Body	Al_2O_3 Ceramic
Pb Free	

TOP VIEW

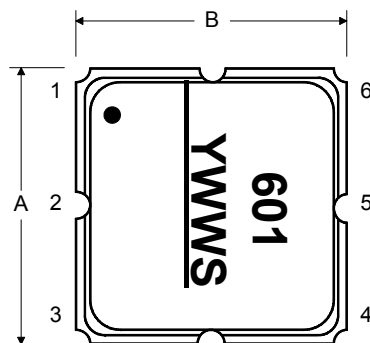

BOTTOM VIEW

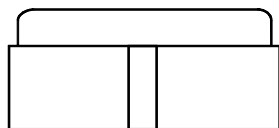
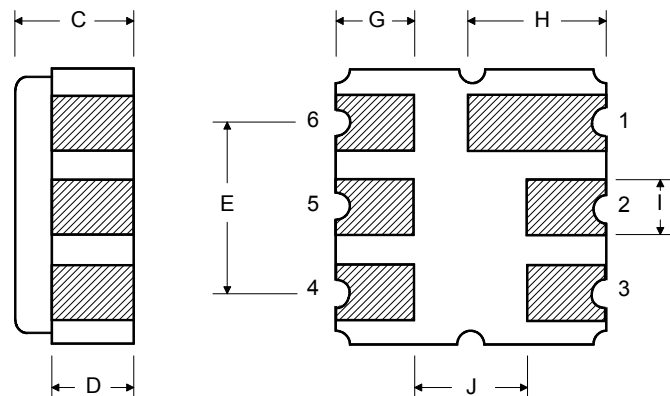

Tape and Reel Specifications

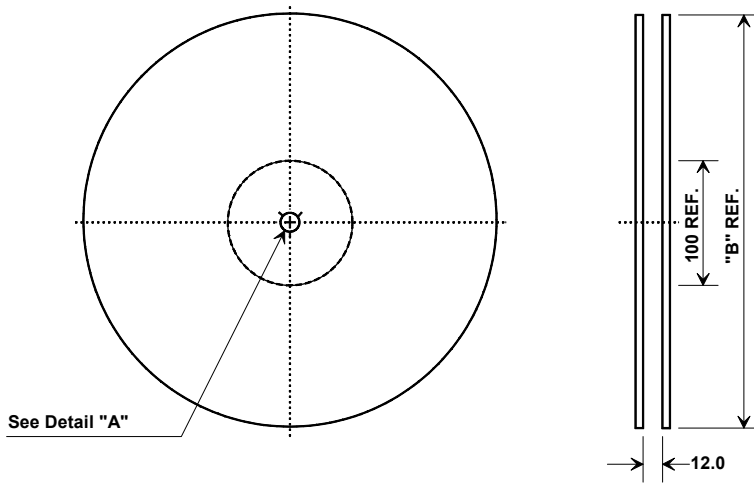

"B "		Quantity Per Reel
Inches	millimeters	
7	178	1000
13	330	3000

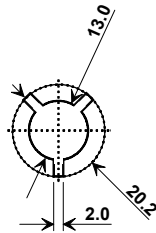

COMPONENT ORIENTATION and DIMENSIONS

Carrier Tape Dimensions	
Ao	4.25 mm
Bo	4.25 mm
Ko	1.30 mm
Pitch	8.0 mm
W	12.0 mm

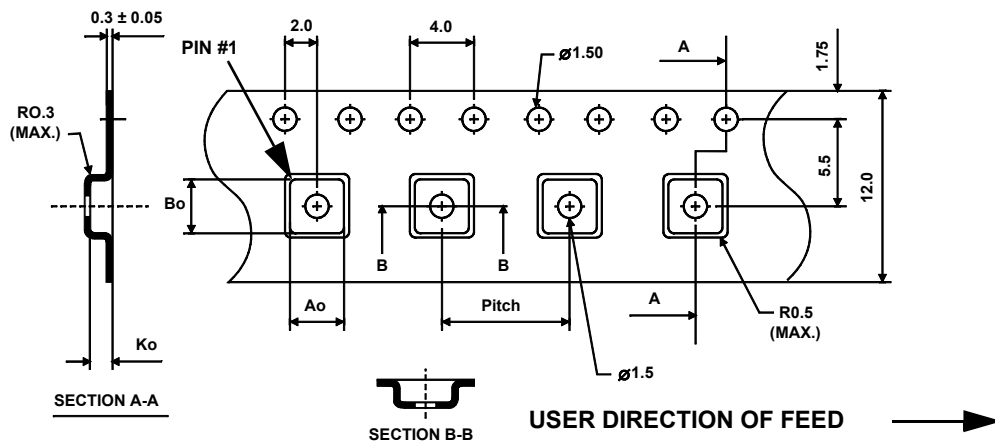

Mouser Electronics

Authorized Distributor

Click to View Pricing, Inventory, Delivery & Lifecycle Information:

[Murata:](#)

[SF1201D](#)