

SF1186E-2

**1575.42 MHz
SAW Filter**

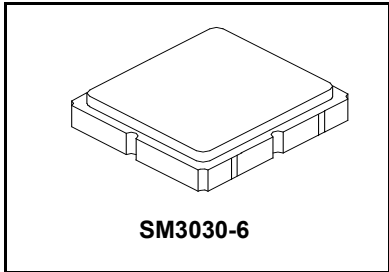

- **Designed for Front-end GPS Applications**
- **Low Insertion Loss**
- **3.0 x 3.0 x 1.3 mm Surface-mount Case**
- **No Matching Circuit Required**
- **Complies with Directive 2002/95/EC (RoHS)**



Maximum Ratings at +25 °C Unless Stated Otherwise

Rating	Symbol	Value	Units
Maximum Input Signal Level		+10	dBm
DC Voltage on any Non-ground Terminal	WVdc	4	Volts
Operating Temperature Range	T _A	-40 to +95	°C
Storage Temperature Range on Tape and Reel	T _{STG}	-40 to +85	°C
Lead Soldering Temperature for 10 Seconds	T _{WAVE}	260	°C
Peak Reflow Solder Temp for 40 Seconds	T _{Reflow}	235	°C
Suitable for lead-free soldering - Max Soldering Temperature		260°C for 30 s	

Electrical Characteristics

Characteristic	Sym	Notes	Min	Typ	Max	Units
Center Frequency	f _O	1	1575.42			MHz
1 dB Bandwidth		1	2.046	15.3		MHz
Passband Amplitude Ripple, f _O ±2.0 MHz				0.1	2.0	dB _{P-P}
Passband VSWR				1.4	2.0	
Insertion Loss		1		2.68	3.5	dB
Attenuation Referenced to 0 dB:						
850 MHz		1	45	51.2		dB
1500 MHz		1	40	52.7		
1535.42 MHz		1	20	38.9		
1615.42 MHz		1	20	58.8		
1640 MHz		1	45	59.1		
1700 MHz		1	50	56.7		
Temperature Coefficient			-30			ppm/°C
Operating Temperature	T _A	1	-40		+95	°C
Single-ended Input /Output Impedance Match	No matching network required for operation at 50 ohms					
Case Style	SM3030-6 3 x 3 mm Nominal Footprint					
Lid Symbolization	y=year, ww=week, s=shift		979 YWWS			
Standard Reel Quantity	Reel Size 7 Inch		6	500 Pieces/Reel		
	Reel Size 13 Inch			3000 Pieces/Reel		

Electrical Connections

Pin #	Description	Pin #	Description
1	Ground	4	Ground
2	Input	5	Output
3	Ground	6	Ground

CAUTION: Electrostatic Sensitive Device. Observe precautions for handling.

NOTES:

1. Unless noted otherwise, all specifications apply over the operating temperature range with filter soldered to the specified demonstration board without impedance matching and measured with 50 Ω network analyzer.
2. The design, manufacturing process, and specifications of this filter are subject to change.
3. Either Port 1 or Port 2 may be used for either input or output in the design. However, impedances and impedance matching may vary between Port 1 and Port 2, so that the filter must always be installed in one direction per the circuit design.
4. US and international patents may apply.
5. Murata, stylized Murata logo, and Murata N.A., Inc. are registered trademarks of Murata Manufacturing Co., Ltd.
6. Tape and Reel Standard Per ANSI/EIA 481.

Transfer function :

(1) S21 response (span : 300 MHz)

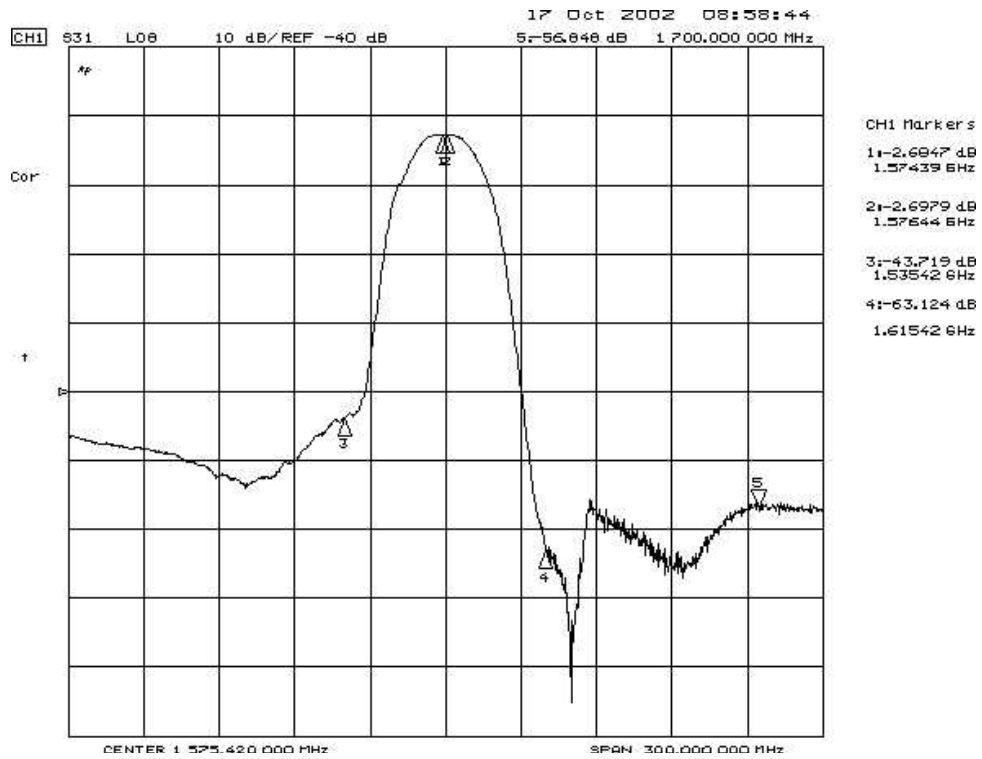

(2) S21 response (span : 3 GHz)

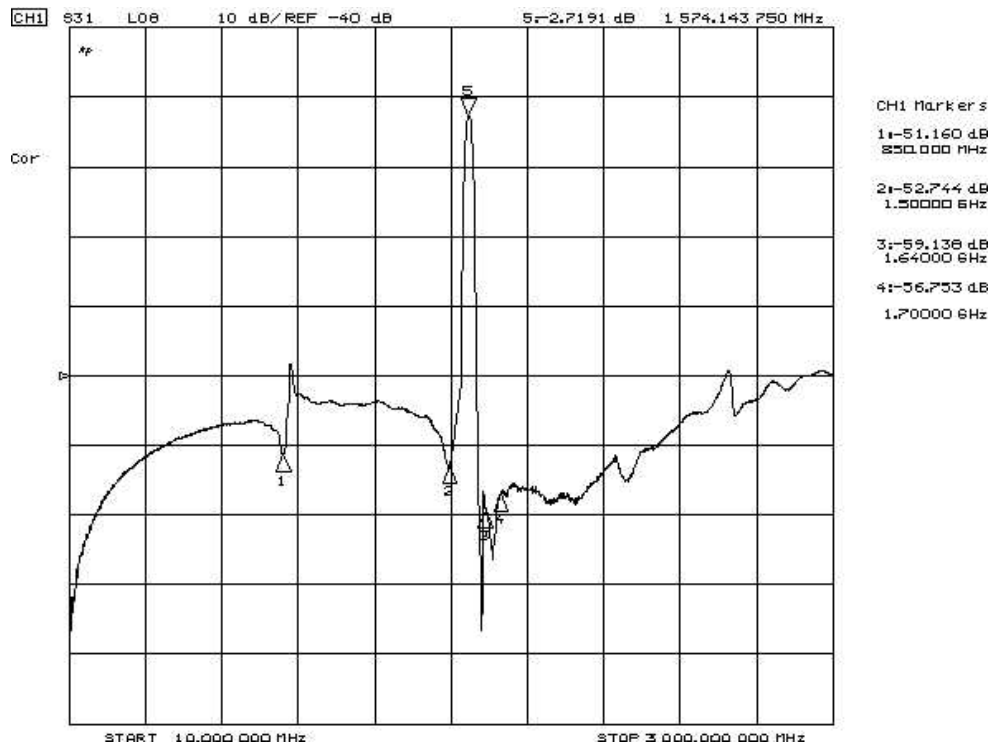

Reflection Functions:

S11

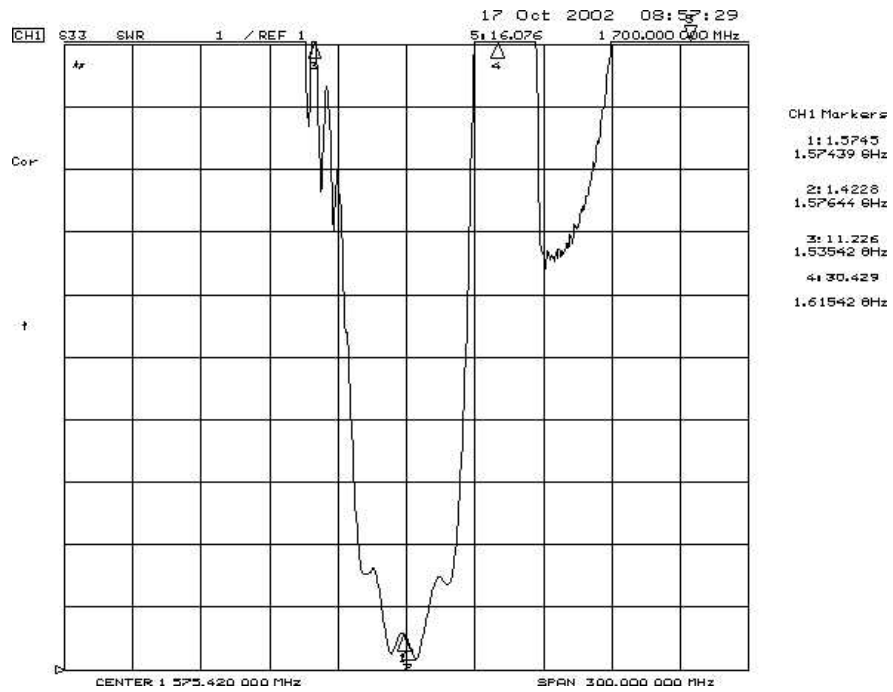

S22

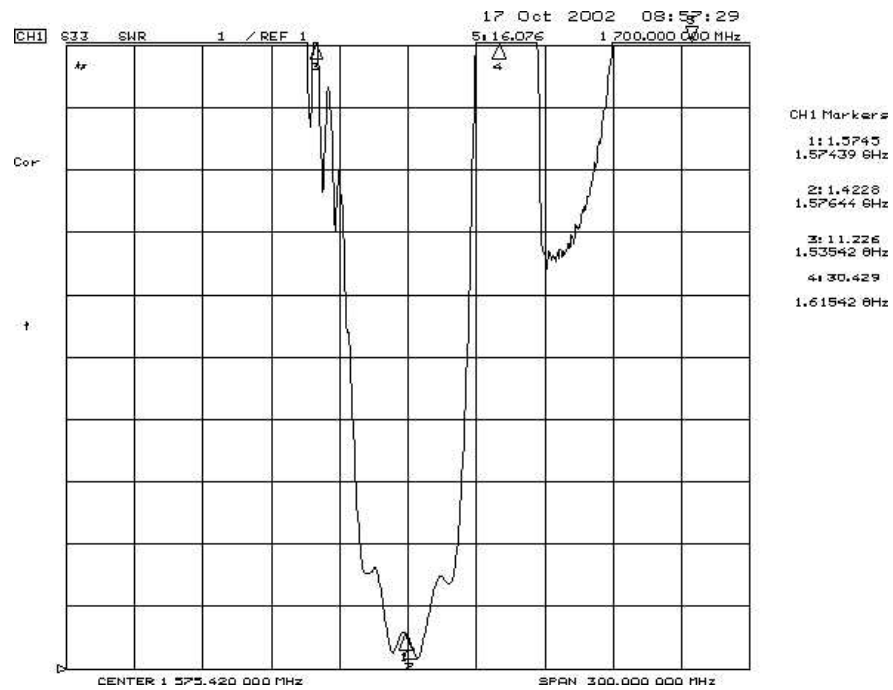

Reflection Functions:

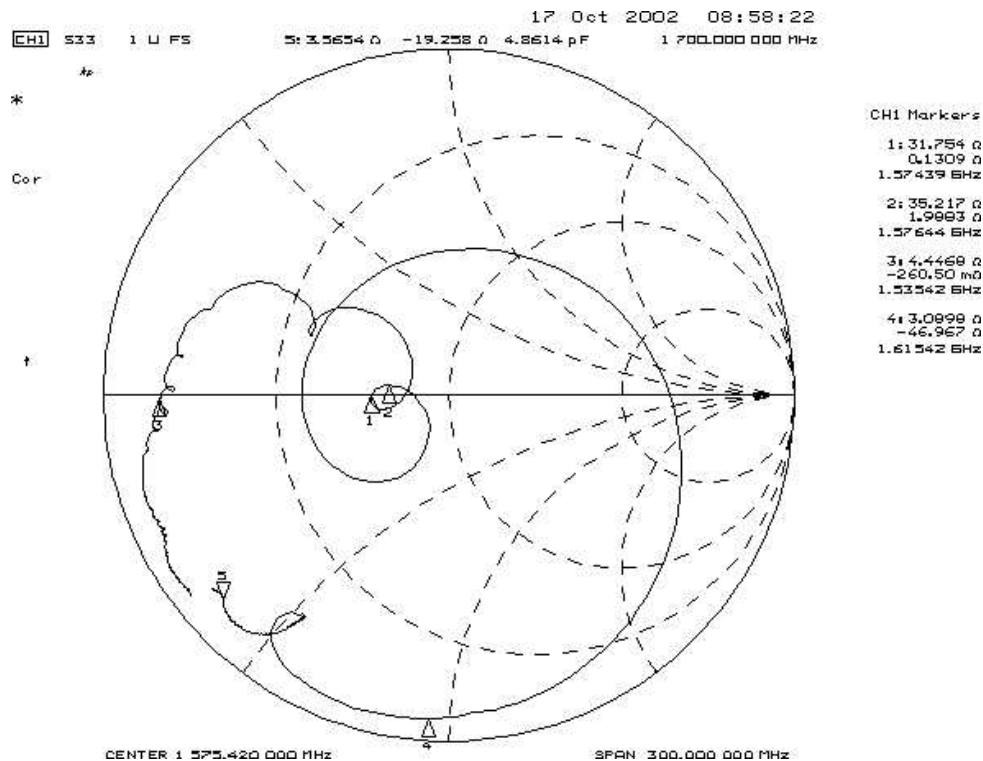
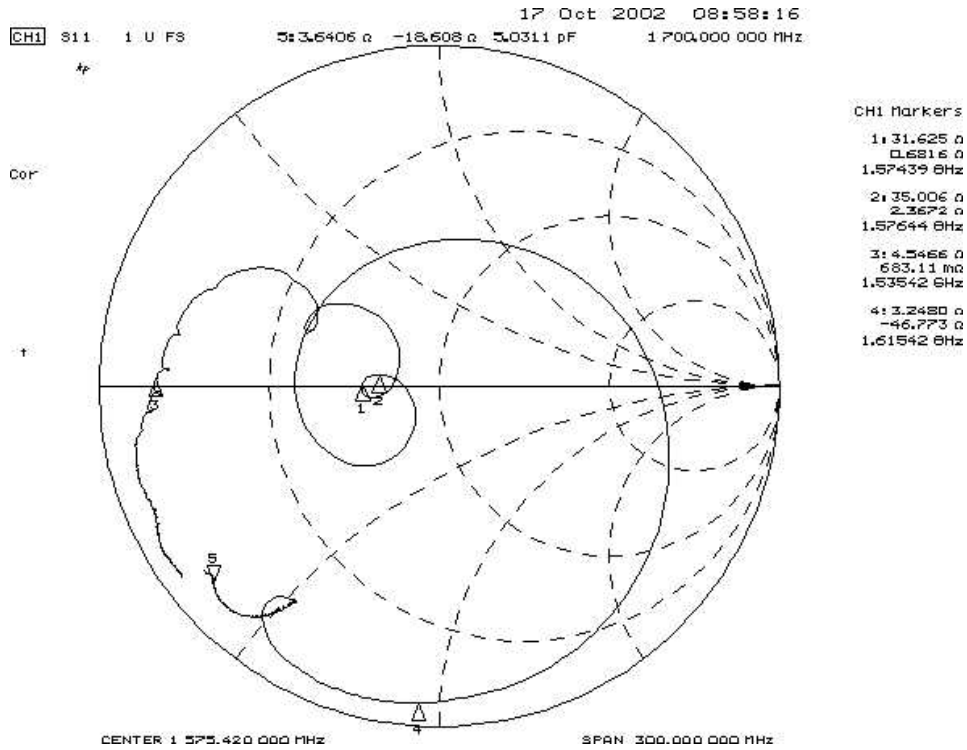

SM3030-6 Case

6-Terminal Ceramic Surface-Mount Case

3.0 X 3.0 mm Nominal Footprint

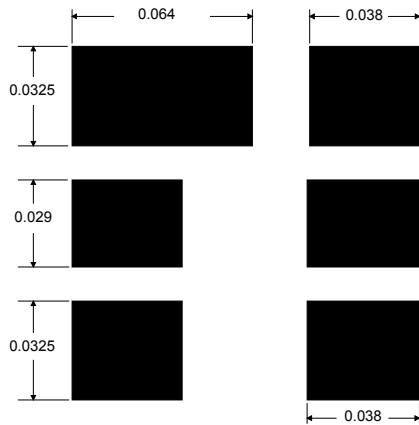
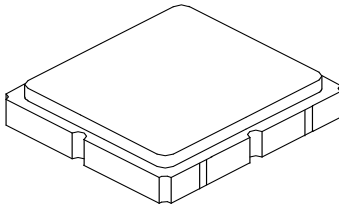

Foot Print Dimensions in Nominal Inches

TOP VIEW

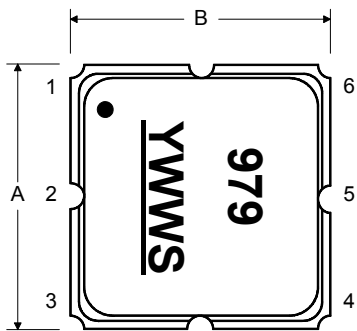

Case Dimensions						
Dimension	mm			Inches		
	Min	Nom	Max	Min	Nom	Max
A	2.87	3.0	3.13	0.113	0.118	0.123
B	2.87	3.0	3.13	0.113	0.118	0.123
C	1.12	1.25	1.38	0.044	0.049	0.054
D	0.77	0.9	1.03	0.030	0.035	0.040
E	2.67	2.80	2.93	0.105	0.110	0.115
F	1.47	1.6	1.73	0.058	0.063	0.068
G	0.72	0.85	0.98	0.028	0.033	0.038
H	1.37	1.5	1.63	0.054	0.059	0.064
I	0.47	0.6	0.73	0.019	0.024	0.029
J	1.17	1.3	1.43	0.046	0.051	0.056

Electrical Connections		
Connection	Terminals	
Port 1	Single-ended Input	2
Port 2	Single-ended Output	5
	Ground	All others
Single-ended Operation Only		
Dot indicates Pin 1		

Case Materials	
Solder Pad Plating	0.3 to 1.0 μm Gold over 1.27 to 8.89 μm Nickel
Lid Plating	2.0 to 3.0 μm Nickel
Body	Al_2O_3 Ceramic
Pb Free	

BOTTOM VIEW

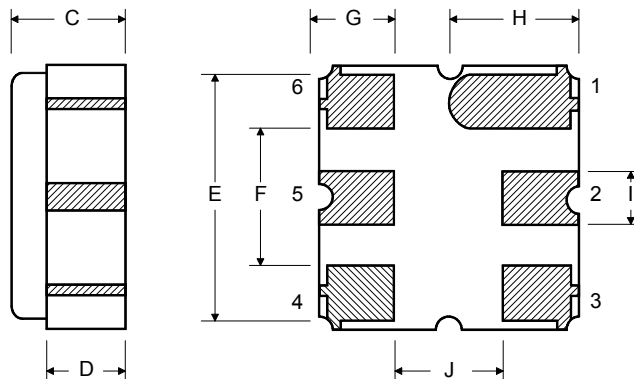

Tape and Reel Specifications

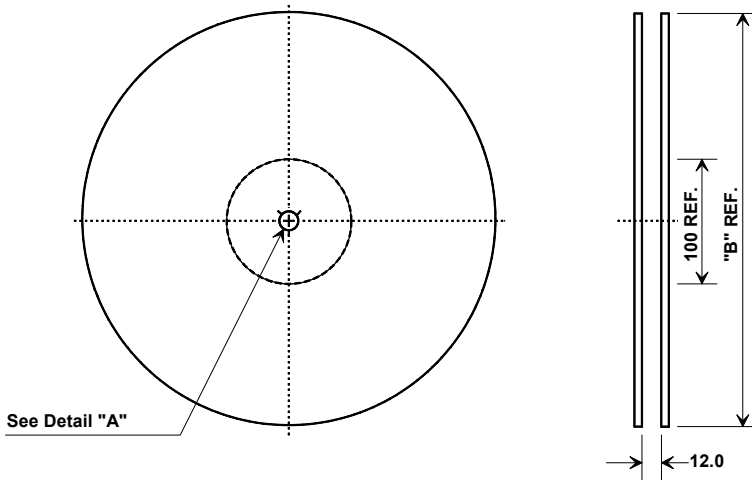

"B"		Quantity Per Reel
Inches	millimeters	
7	178	500
13	330	3000

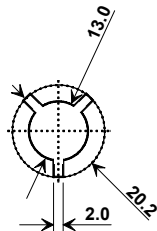

COMPONENT ORIENTATION

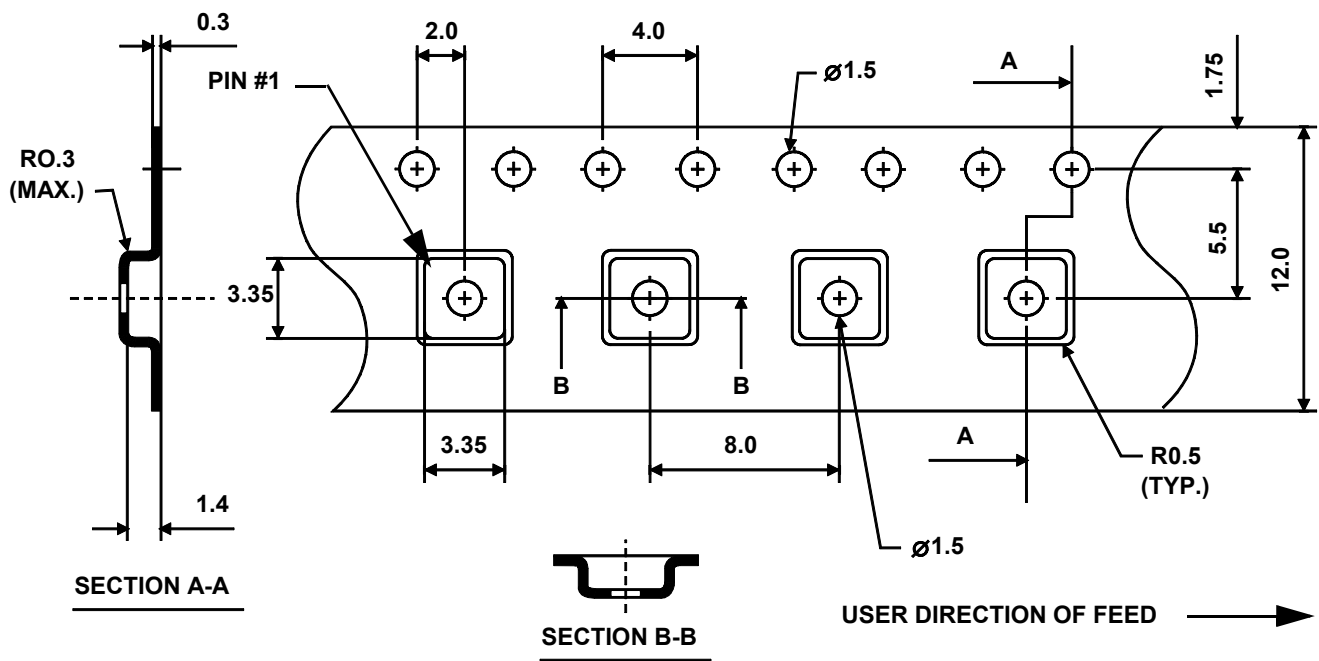

Mouser Electronics

Authorized Distributor

Click to View Pricing, Inventory, Delivery & Lifecycle Information:

[Murata:](#)

[SF1186E-2](#)