

SF1174D

**374.00 MHz
SAW Filter**

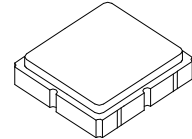

SM3838-8 Case

- *Designed for 802.11 Applications*
- *Hermetically sealed Surface Mount package*
- *Complies with Directive 2002/95/EC (RoHS)*



Absolute Maximum Ratings

Rating	Value	Units
Maximum Input Power	+10	dBm
DC Voltage Between Terminals	30	VDC
Case Temperature	-40 to +85	°C
Suitable for lead-free soldering - Max Soldering Profile	260°C for 30 s	

Electrical Characteristics

Characteristic		Sym	Notes	Minimum	Typical	Maximum	Units
Nominal Operating Frequency		f_c			374		MHz
Passband	Insertion Loss	IL			8.6	10	dB
	3.0 dB Bandwidth			17	23.3		MHz
Amplitude Ripple	$F_c \pm 7$ MHz				.6	1.0	dB
Group Delay Deviation	$F_c \pm 7$ MHz				45	100	nsec
Rejection	$F_c - 100$ to -33 MHz			40	47		dB
	$F_c - 33$ to -22 MHz			40	48		dB
	$F_c - 22$ to -16.5 MHz			27	40		dB
	$F_c + 16.5$ to $+22$ MHz			28	44		dB
	$F_c + 22$ to $+43$ MHz			35	44		dB
Ambient Temperature	Operating Range			-20		70	°C
Footprint Size: 3.8 X 3.8	SM3838-8						
Lid Symbolization (Y=Year, WW=week, S=shift)	479 // YWWWS						

Electrical Connections

Connection	Terminals
Differential Input	2, 3
Differential Output	6, 7
Ground	All Others

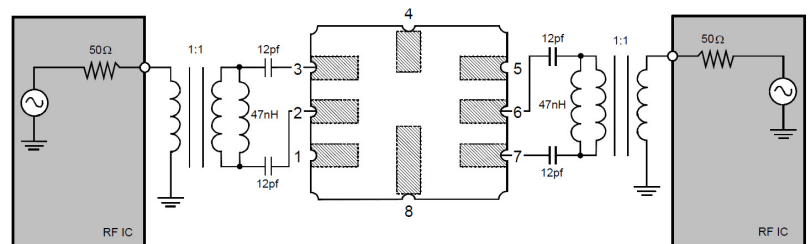

CAUTION: Electrostatic Sensitive Device. Observe precautions for handling.

NOTES:

1. All specifications apply over the operating temperature range with filter soldered to the specified demonstration board unless noted otherwise.
2. Ultimate rejection is dependent on PCB layout.
3. Specifications subject to change without notice.
4. Electrostatic Sensitive Device. Observe precautions for handling.
5. US and international patents may apply.
6. Murata, stylized Murata logo, and Murata N.A., Inc. are registered trademarks of Murata Manufacturing Co., Ltd.

SF1174D-Demo Reference Plot

1dB per transformer insertion loss is not calibrated out

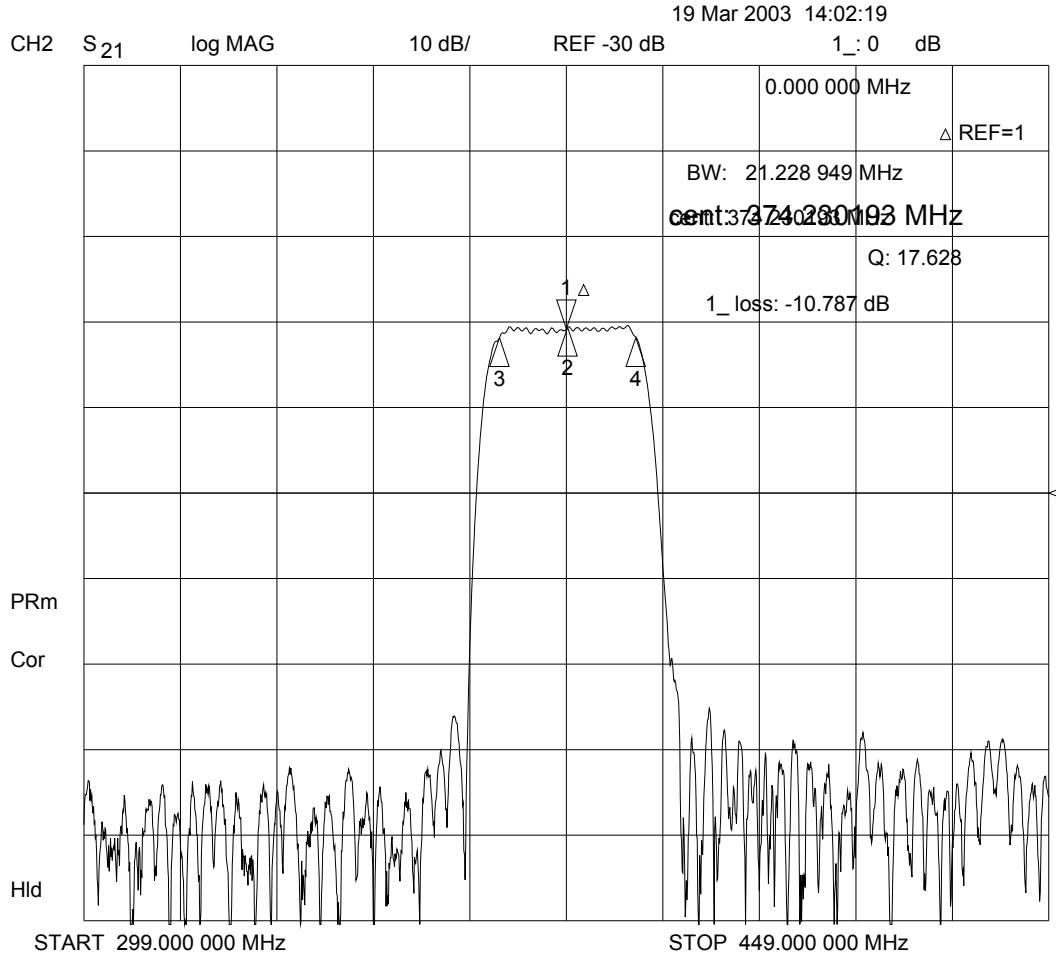

SF1174D-Demo Reference Plot

19 Mar 2003 14:04:58

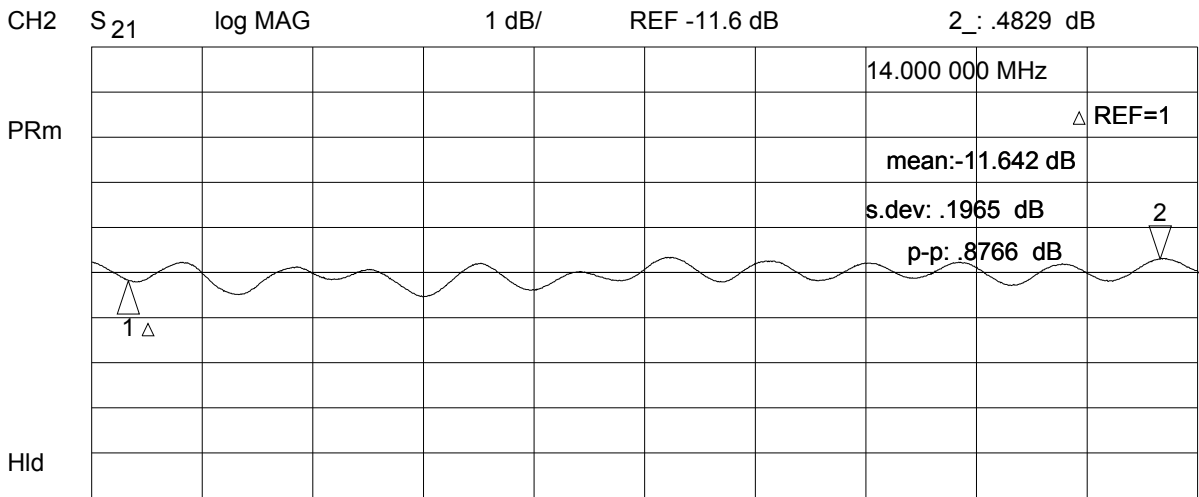
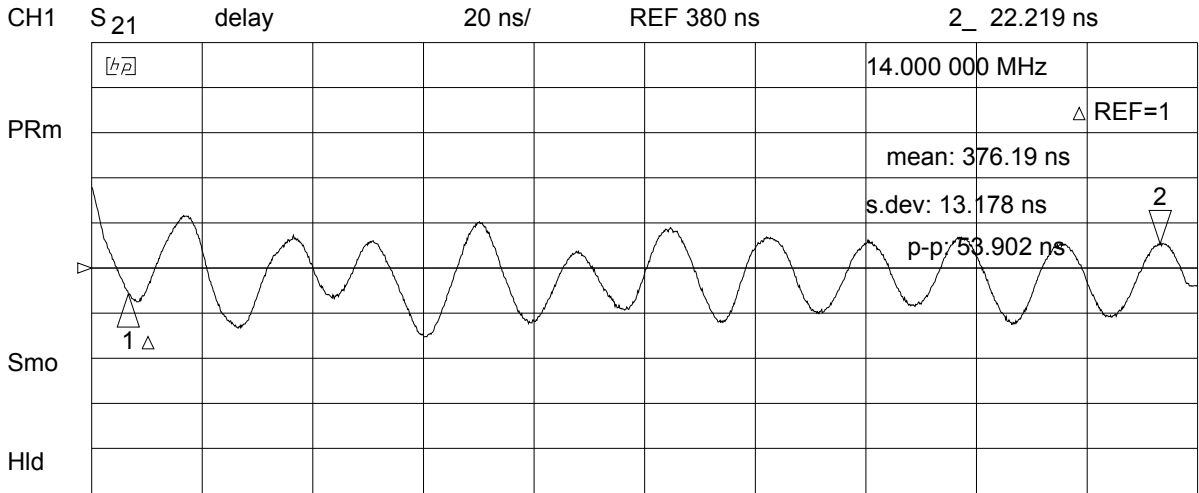

CENTER 374.000 000 MHz

SPAN 15.000 000 MHz

SM3838-8 Case

8-Terminal Ceramic Surface-Mount Case

3.8 X 3.8 mm Nominal Footprint

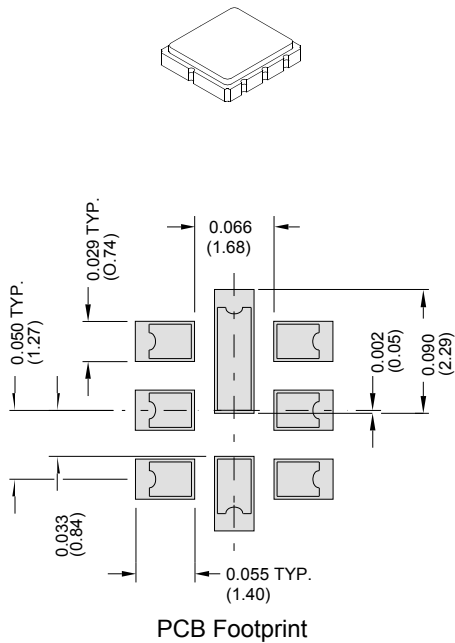

TOP VIEW

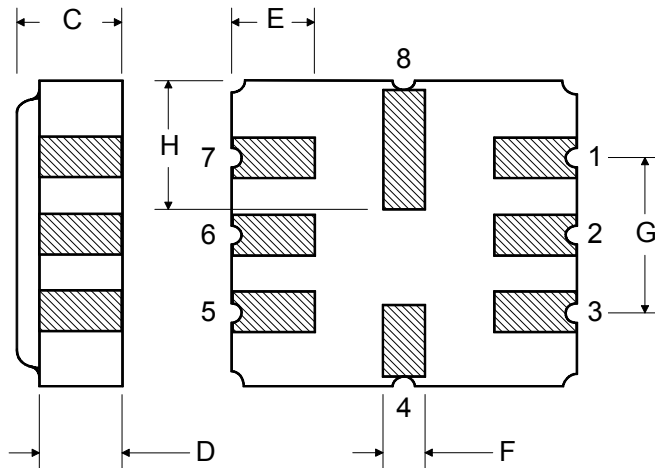
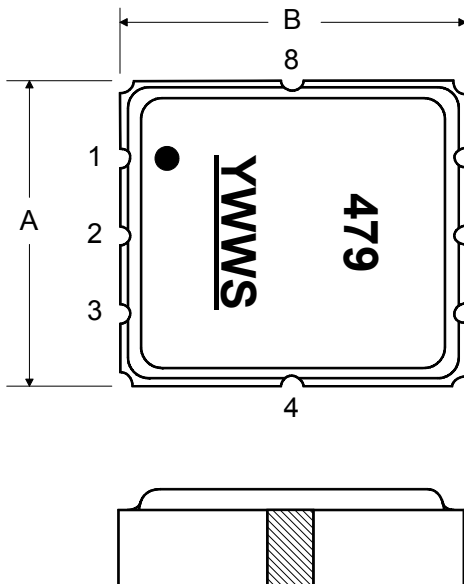

Case Dimensions						
Dimension	mm			Inches		
	Min	Nom	Max	Min	Nom	Max
A	3.6	3.8	4.0		0.15	
B	3.6	3.8	4.0		0.15	
C			1.25		0.06	
D		1.0			0.04	
E		1.0			0.04	
F		0.6			0.02	
G	2.39	2.54	2.69		0.100	
H		1.5			0.06	

Electrical Connections		
	Connection	Terminals
Port 1	Differential Input	2, 3
Port 2	Differential Output	6, 7
	Ground	All Others
Single Ended Operation		Return is Ground
Differential Operation		Return is Hot
Dot Indicates Pin 1		

Materials	
Solder Pad Termination	Au plating 30 - 60 ulnches (76.2-152 uM) over 80-200 ulnches (203-508 uM) Ni.
Lid	Fe-Ni-Co Alloy Electroless Nickel Plate (8-11% Phosphorus) 100-200 ulnches Thick
Body	Al ₂ O ₃ Ceramic

BOTTOM VIEW

Tape and Reel Specifications

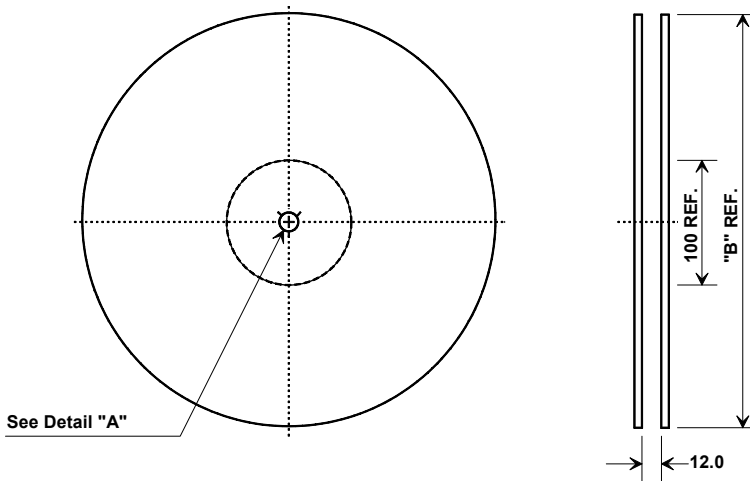

"B" Nominal Size		Quantity Per Reel
Inches	millimeters	
7	178	500
13	330	3000

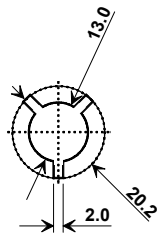

COMPONENT ORIENTATION and DIMENSIONS

Carrier Tape Dimensions	
Ao	4.25 mm
Bo	4.25 mm
Ko	1.30 mm
Pitch	8.0 mm
W	12.0 mm

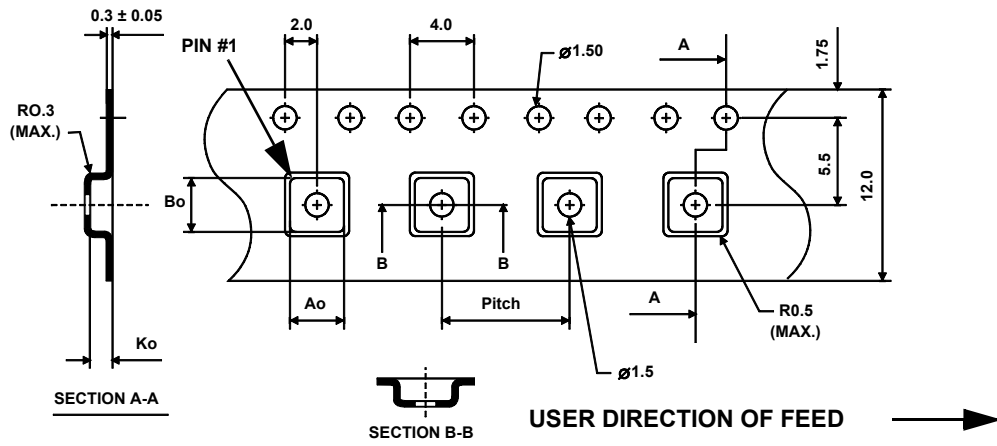

Mouser Electronics

Authorized Distributor

Click to View Pricing, Inventory, Delivery & Lifecycle Information:

[Murata:](#)

[SF1174D](#)