



### FEATURES

- RoHS compliant
- Up to 2.0A I<sub>dc</sub>
- 1.0μH to 470μH
- Ultra low profile
- Low R<sub>DC</sub>
- Tape and reel packaging
- J-STD-020C reflow
- Backward compatible with Sn/Pb soldering systems

### DESCRIPTION

The 8200 series is a range of miniature, surface-mount, I-core power inductors. They are designed for use in power applications with restricted PCB space and height, such as ExpressCard™ technology, handheld devices, DC-DC converters and notebook computers. The products are supplied in tape and reel for high-volume, automated surface-mount assembly.

### SELECTION GUIDE

Order Code	Inductance, L		I <sub>dc</sub> (Max.) <sup>1</sup>	Q Factor		SRF (Typ.) MHz	R <sub>dc</sub> (Max.) Ω
	0.1V @ 10KHz	Tolerance		Q (Min.)	at frequency		
	μH	%	A				
82102C	1.0	±20%	2.0	18	1MHz	133	0.058
82152C	1.5	±20%	1.4	18	1MHz	103	0.068
82222C	2.2	±20%	1.1	18	1MHz	85	0.104
82332C	3.3	±20%	0.95	18	1MHz	67	0.138
82472C	4.7	±20%	0.80	20	1MHz	58	0.190
82682C	6.8	±20%	0.64	20	1MHz	46	0.270
82103C	10	±10%	0.50	35	1MHz	38	0.400
82153C	15	±10%	0.40	35	1MHz	31	0.560
82223C	22	±10%	0.32	35	1MHz	25	0.920
82333C	33	±10%	0.27	40	1MHz	20	1.30
82473C	47	±10%	0.25	40	1MHz	17	1.69
82683C	68	±10%	0.20	40	1MHz	15	2.55
82104C	100	±10%	0.16	40	800k	13	3.5
82154C	150	±10%	0.13	40	800k	11	5.9
82224C	220	±10%	0.10	40	800k	10	8.0
82334C	330	±10%	0.08	40	800k	9	13.5
82474C	470	±10%	0.07	50	800k	9	16.8

### ABSOLUTE MAXIMUM RATINGS

Operating free air temperature range	-40°C to 85°C
Storage temperature range	-40°C to 125°C

### SOLDERING INFORMATION<sup>2</sup>

Peak reflow temperature	260°C
Pin finish	Hot dipped tin

Specifications typical at T<sub>a</sub> = 25°C

- 1 The maximum DC current occurs when either the inductance falls to 75% of its nominal value or when its temperature rise reaches 40°C, whichever is sooner.
- 2 For further information, please visit [www.murata-ps.com/rohs](http://www.murata-ps.com/rohs)



For full details go to [www.murata-ps.com/rohs](http://www.murata-ps.com/rohs)

**INDUCTANCE Vs CURRENT**

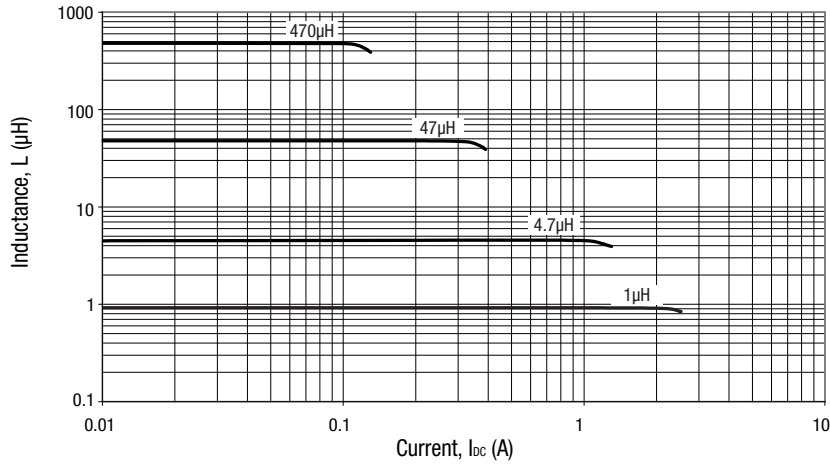

**TEMPERATURE Vs CURRENT**

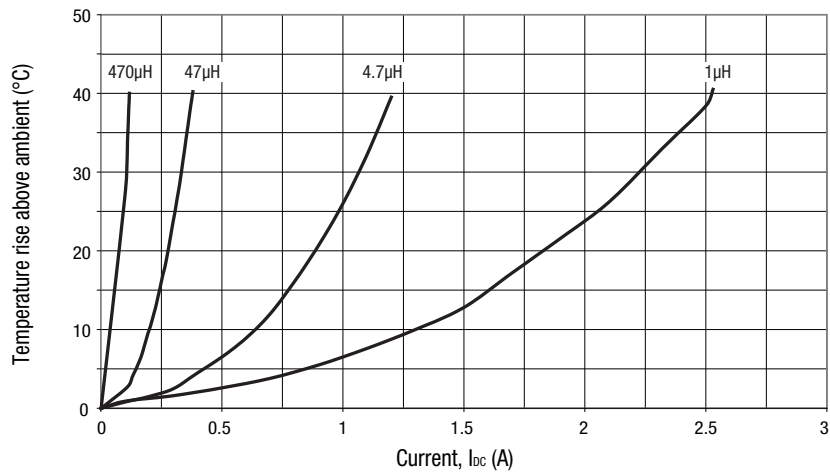

**INDUCTANCE Vs FREQUENCY**

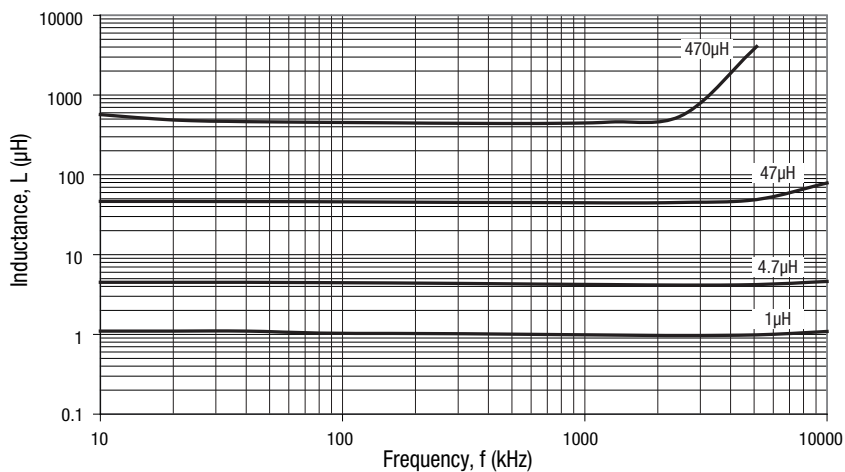

**PACKAGE SPECIFICATIONS**

**MECHANICAL DIMENSIONS**

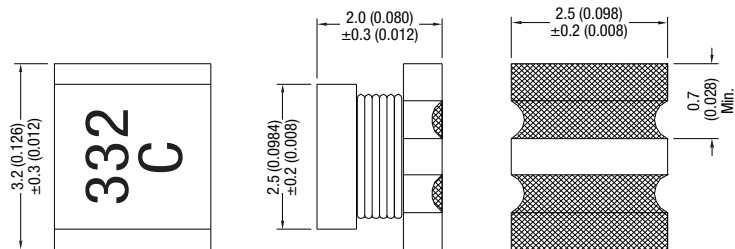

Unless otherwise stated all dimensions in mm (inches) ±0.25 (0.01).  
Package Weight 0.06g Typ.

**RECOMMENDED FOOTPRINT**

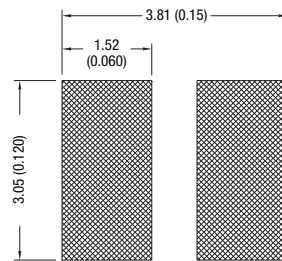

Unless otherwise stated all dimensions in mm (inches) ±0.25 (0.01).

**TAPE OUTLINE DIMENSIONS**

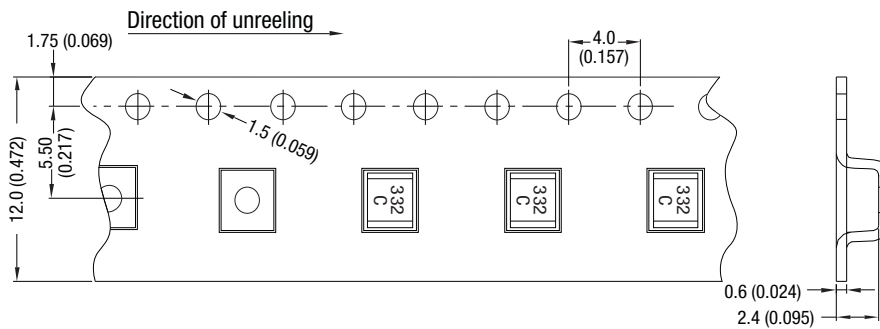

Reel Quantity: 2500  
Unless otherwise stated all dimensions in mm (inches)

**PACKAGE SPECIFICATIONS (continued)**

**REEL OUTLINE DIMENSIONS**

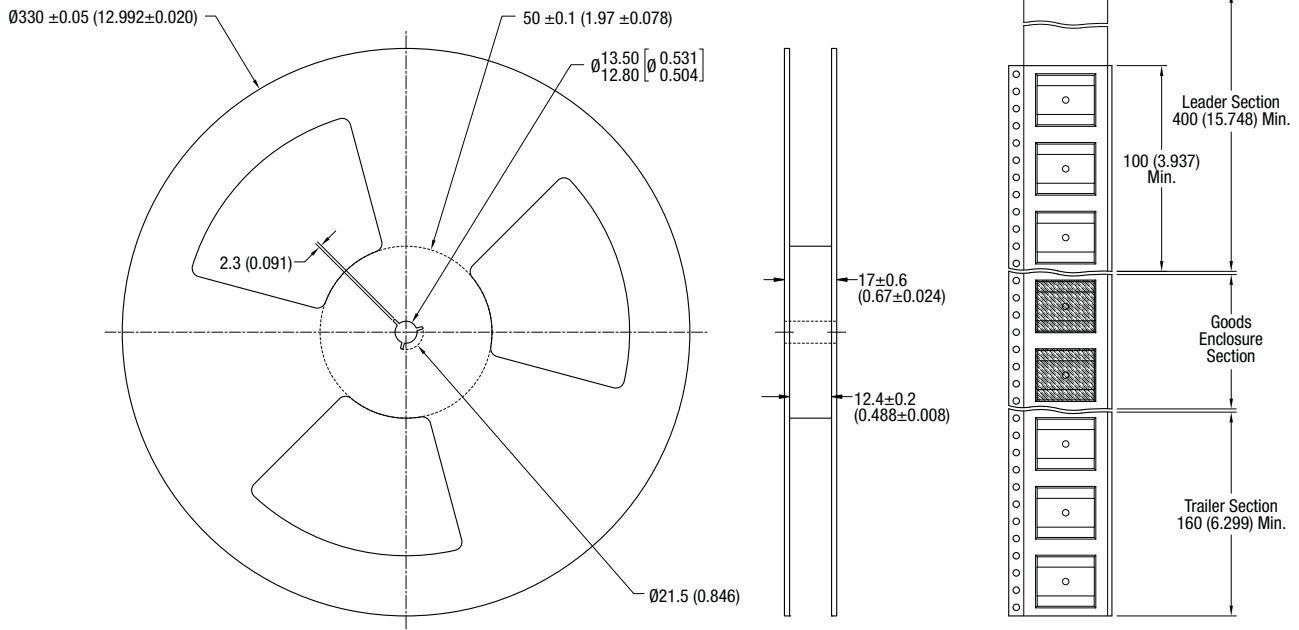

All dimension in mm [inches]  
Tape and reel specifications conform with international standards EIA-481-C

# Mouser Electronics

Authorized Distributor

Click to View Pricing, Inventory, Delivery & Lifecycle Information:

## Murata:

[82102C](#) [82103C](#) [82104C](#) [82152C](#) [82153C](#) [82154C](#) [82222C](#) [82224C](#) [82332C](#) [82333C](#) [82334C](#) [82472C](#)  
[82474C](#) [82682C](#) [82683C](#) [82223C](#) [82473C](#)