

DESCRIPTION

The EV4012DS-00A Evaluation Board is designed to demonstrate the capabilities of MPS' MP4012DS for TV backlighting applications. MP4012DS is a current mode controller designed for high brightness LEDs.

With a 50-90V input V_{IN} and a 12V power supply for MP4012DS, EV4012DS-00A can deliver a regulated voltage to drive a LED string. The LED current is regulated to about 120mA, The EV4012DS-00A can be synchronized, Several EV4012DS-00As can be used together to drive a TV panel.

ELECTRICAL SPECIFICATION

Parameter	Symbol	Value	Units
Input Voltage	V_{IN}	50-90	V
IC Power Supply	12VIN	12±10%	V
PWM Dimming	PWM	5±10%	V
LED Current	I_{LED}	120	mA
Switching Frequency	f_s	100	kHz
Over Voltage Protection	$V_{LED-Max}$	212	V

FEATURES

- Constant Current WLED Driver
- High Frequency PWM Dimming
- Switching Frequency Synchronization
- Open Load Hiccup Mode Protection
- Short Load Hiccup Mode Protection
- Programmable Cycle-by-Cycle Over Current Protection
- UVLO, Thermal Shutdown Protection
- Soft Start

APPLICATIONS

- TV Backlighting
- Large LCD Panel Backlighting

All MPS parts are lead-free and adhere to the RoHS directive. For MPS green status, please visit MPS website under Quality Assurance. "MPS" and "The Future of Analog IC Technology", are Registered Trademarks of Monolithic Power Systems, Inc.



Warning: Although this board is designed to satisfy safety requirements, the engineering prototype has not been agency approved. Therefore, all testing should be performed using an isolation transformer to provide the AC input to the prototype board.

EV4012DS-00A EVALUATION BOARD



(L x W x H) 7.35cm x 5.84cm x 14mm

Board Number	MPS IC Number
EV4012DS-00A	MP4012DS

Efficiency vs. V_{IN}

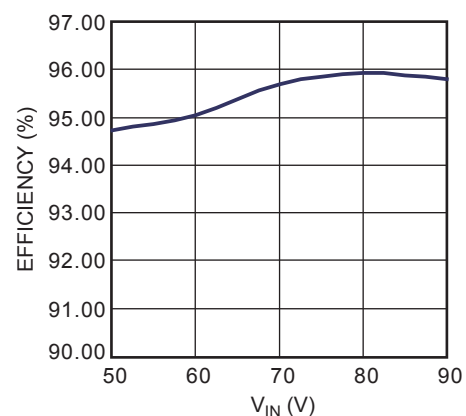

EVALUATION BOARD SCHEMATIC

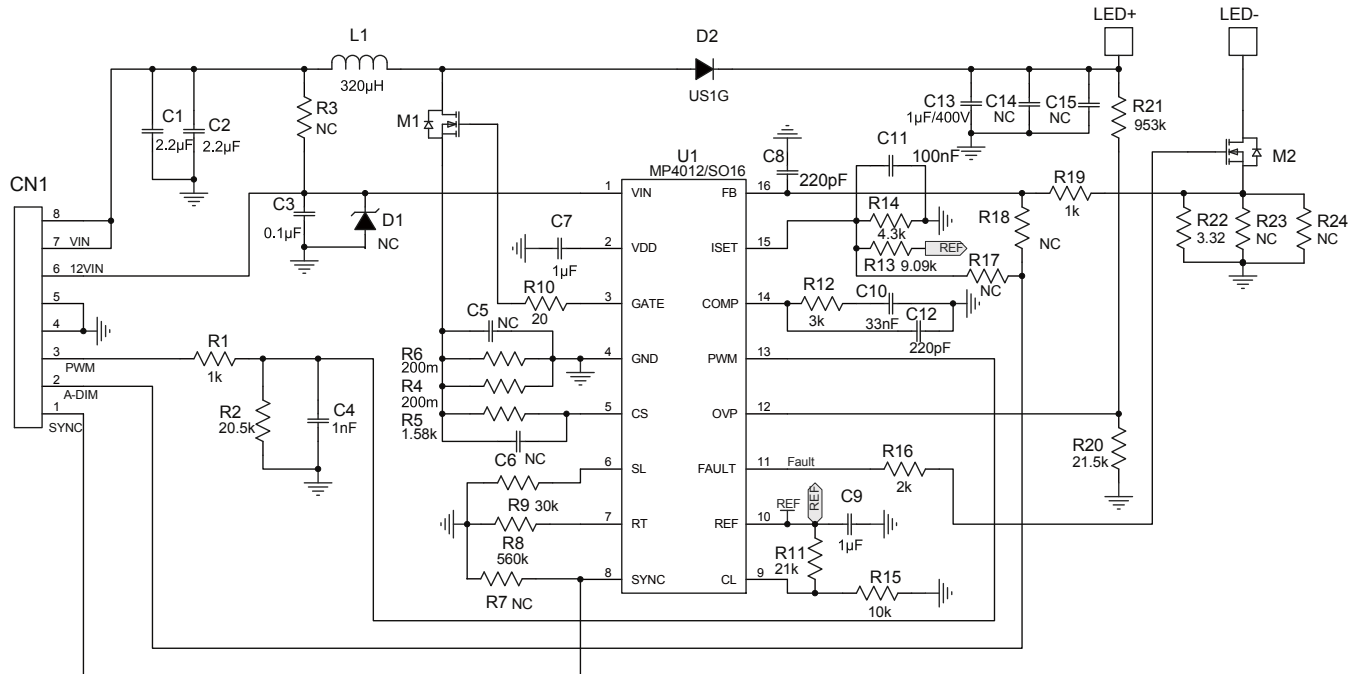

EV4012DS-00A BILL OF MATERIALS

Qty	Ref	Value	Description	Package	Manufacturer	Manufacturer P/N
2	C1, C2	2.2µF	Ceramic Capacitor;100V;X7R;1210	1210	muRata	GRM32ER72A225KA35L
1	C3	0.1µF	Ceramic Capacitor;100V;X7R;0805	0805	TDK	C2012X7R2A104K
1	C4	1nF	Ceramic Capacitor;50V;X7R;0603	0603	TDK	C1608X7R1H102K
4	C5, C6, C14, C15	NC				
1	C7	1µF	Ceramic Capacitor;25V;X5R;0805	0805	muRata	GRM216R61E105KA12D
2	C8, C12	220pF	Ceramic Capacitor;50V;X7R;0603	0603	muRata	GRM188R71H221KA01D
1	C9	1µF	Ceramic Capacitor;25V;X7R;0603	0603	muRata	GRM188R71E105KA12
1	C10	33nF	Ceramic Capacitor;50V;X7R;0603	0603	muRata	GRM188R1H333KA61D
1	C11	100nF	Ceramic Capacitor;25V;X7R;0603	0603	muRata	GRM188R71H104KA01D
1	C13	1µF/400V	Film Capacitor;400V; DIP	DIP		CBB 1µF/400V
2	LED+, LED-		Connector			Connector

EV4012DS-00A BILL OF MATERIALS (continued)

Qty	Ref	Value	Description	Package	Manufacturer	Manufacturer P/N
1	CN1		CONN/9PIN/2.54MM/ Right angle			CONN/9PIN/2.54MM
1	D1	NC				
1	D2	US1G	Diode;400V;1A	SMA	MULTICOMP	US1G
1	L1	320µH	Inductor;320uH;EFD20	DIP		Inductor
1	M1	SMK730F	N-MOS;400V;5.5A;1Ω	TO-220	AUK	SMK730F
1	M2	SMK0260D	N-MOS;600V;2A;3.9Ω	TO-252	AUK	SMK0260D
1	JR1	0	Film Resistor;5%	0603	Royalohm	0603J0000T5E
1	JR2	0	Film Resistor;5%	1206	Yageo	RC1206JR-070RL
1	JR3	0	Film Resistor;5%	0805	Royalohm	0805S8J0000T5E
5	JW1, JW2, JW3, JW4, JW5		JUMP WIRE			JUMP WIRE
2	R1, R19	1k	Film Resistor;1%	0603	Yageo	RC0603FR-071KL
1	R2	20.5k	Film Resistor;1%	0603	Yageo	RC0603FR-0720K5L
6	R3, R7, R17, R18, R23, R24	NC				
2	R4, R6	200m	Sense Resistor;1%;1/2W	1206	CYNTEC	RL1632H-R200-FN
1	R5	1.58k	Film Resistor;1%	0603	Yageo	RC0603FR-071K58L
1	R8	560k	Film Resistor;1%	0603	Yageo	RC0603FR-07560KL
1	R9	30k	Film Resistor;1%;	0603	Yageo	RC0603FR-0730KL
1	R10	20	Film Resistor;1%;	0603	Yageo	RC0603FR-0720RL
1	R11	21k	Film Resistor;1%	0603	Yageo	RC0603FR-0721KL
1	R12	3k	Film Resistor;1%	0603	Yageo	RC0603FR-073KL
1	R13	9.09k	Film Resistor;1%	0603	Yageo	RC0603FR-079K09L
1	R14	4.3k	Film Resistor;1%	0603	LION	RC0603FR-074K3L
1	R15	10k	Film Resistor;1%	0603	Yageo	RC0603FR-0710KL
1	R16	5.1k	Film Resistor;1%	0603	Yageo	RC0603FR-075K1L
1	R20	23.2k	Film Resistor;1%	0603	Yageo	RC0603FR-0723K2L
1	R21	1M	Film Resistor;1%	1206	Yageo	RC0603FR-071ML
1	R22	3.3	Resistor;1%	1206	Royalohm	1206F330KT5E
1	U1	MP4012DS	MP4012DS	SOIC16		MP4012DS

EVB TEST RESULTS

Performance waveforms are tested on the evaluation board.

VIN = 64V, 12VIN=12V, VLED=200V, ILED = 120mA, TA = 20°C, unless otherwise noted.

PWM Dimming Curve

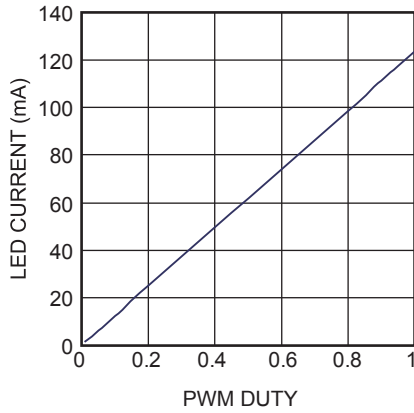

Steady State

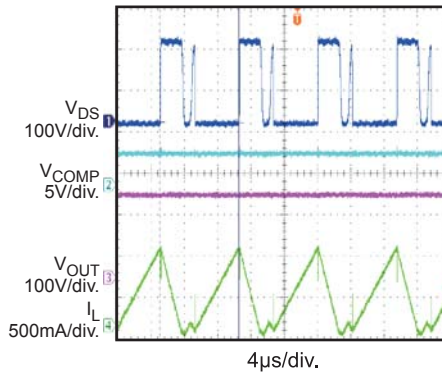

Soft Start

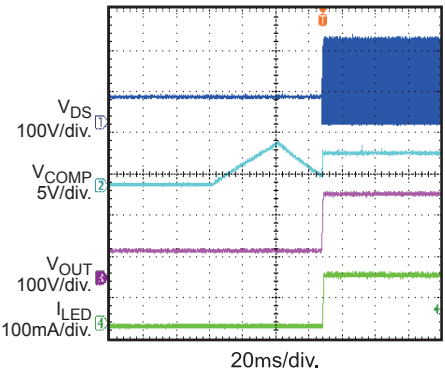

PWM Dimming

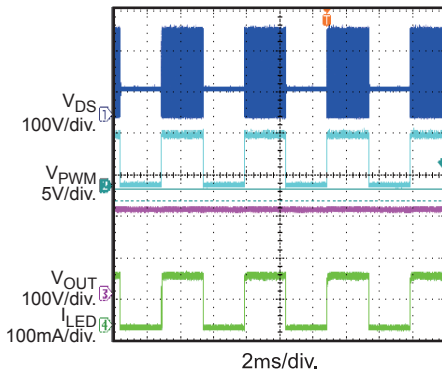

OVP Recovery

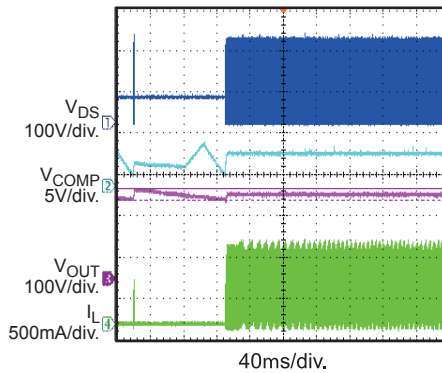

Short Load Recovery

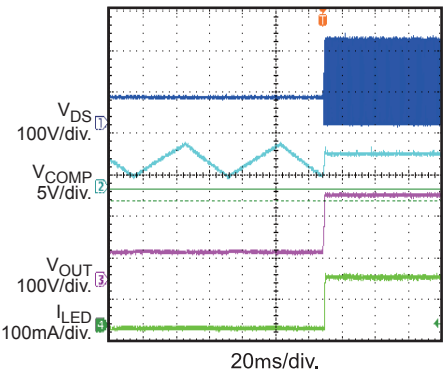

PRINTED CIRCUIT BOARD LAYOUT

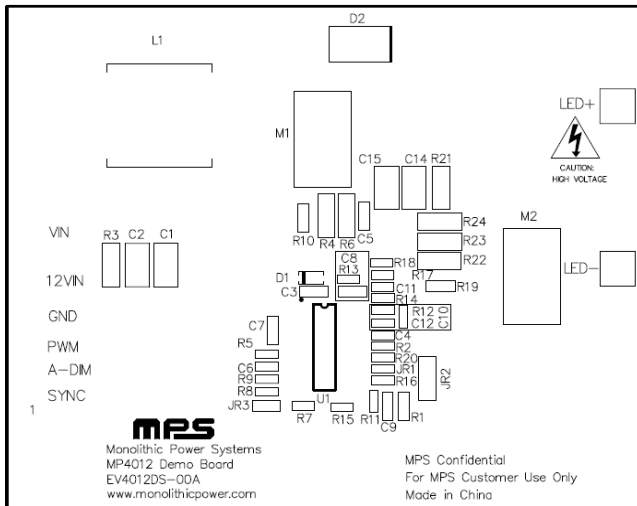

Figure 1—Top Silk Layer

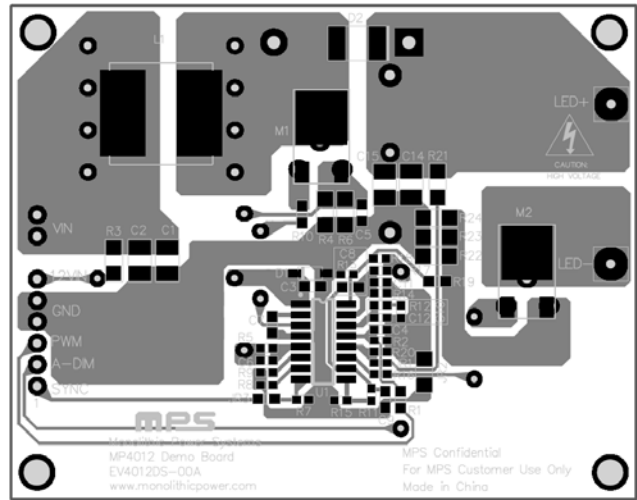

Figure 2—Top Layer

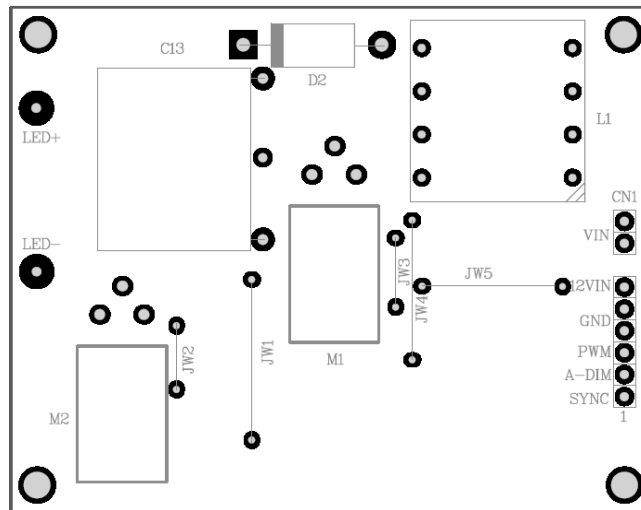

Figure 3—Bottom Layer

QUICK START GUIDE

1. Check the LED string voltage and preset the input voltage power supply to 50-90V.
2. Set a second power supply 12VIN to 12V as the power supply of IC. Set a third power supply to 5V as the PWM input to the EVB.
3. Connect all SYNC pin of all EVBs for synchronization if necessary.
4. Turn-off all power supplies. Connect all the power supply.
5. Connect the anode of the LED string to LED+, and the cathode to LED-.
6. Turn on the VIN power supply.
7. Turn on the 5V PWM power supply.
8. Turn on the 12VIN power supply. The LED string should be lighten
9. To demo the dimming function: replace the 5V PWM power supply with a function generator. Set the PWM signal amplitude to 5V and the frequency within 100Hz to 2kHz range.

NOTICE: The information in this document is subject to change without notice. Please contact MPS for current specifications. Users should warrant and guarantee that third party Intellectual Property rights are not infringed upon when integrating MPS products into any application. MPS will not assume any legal responsibility for any said applications.

Mouser Electronics

Authorized Distributor

Click to View Pricing, Inventory, Delivery & Lifecycle Information:

[Monolithic Power Systems \(MPS\):](#)

[EV4012DS-00A](#)