

**PLEASE CHECK WWW.MOLEX.COM FOR LATEST PART INFORMATION**

**Part Number:** [52892-1295](#)  
**Status:** **Active**  
**Description:** 0.50mm Pitch Easy-On™ Type FFC/FPC Connector, Right Angle, SMT, ZIF, Bottom Contact Style, Cable Retention Guide, 12 Circuits, Lead-Free

**Documents:**

[3D Model](#) [Packaging Specification SPK-52892-001 \(PDF\)](#)  
[Drawing \(PDF\)](#) [RoHS Certificate of Compliance \(PDF\)](#)  
[Product Specification PS-52892-038 \(PDF\)](#)

**General**

Product Family	FFC/FPC Connectors
Series	<a href="#">52892</a>
Comments	Hinge, Cable Guide
Product Name	Easy-On™
UPC	822348116423

**Physical**

Circuits (Loaded)	12
Color - Resin	Natural
Contact Position	Bottom
Durability (mating cycles max)	20
Entry Angle	90° Angle
Mated Height	2.00mm
Material - Metal	Phosphor Bronze
Material - Plating Mating	Tin-Bismuth
Material - Plating Termination	Tin-Bismuth
Material - Resin	High Temperature Thermoplastic
Net Weight	154.908/mg
Number of Rows	1
Orientation	Right Angle
PCB Locator	No
PCB Retention	Yes
Packaging Type	Embossed Tape on Reel
Pitch - Mating Interface	0.50mm
Plating min - Mating	1.016µm
Plating min - Termination	1.016µm
Polarized to PCB	No
Stackable	No
Surface Mount Compatible (SMC)	N/A
Temperature Range - Operating	-25°C to +85°C
Termination Interface: Style	Surface Mount
Wire/Cable Type	FFC/FPC

**Electrical**

Current - Maximum per Contact	0.5A
Voltage - Maximum	50V

**Material Info**

**Reference - Drawing Numbers**

Packaging Specification	SPK-52892-001
Product Specification	PS-52892-038, RPS-52892-036, RPS-52892-039, RPS-52892-045, RPS-52892-049, RPS-52892-052
Sales Drawing	SD-52892-040, SD-52892-041

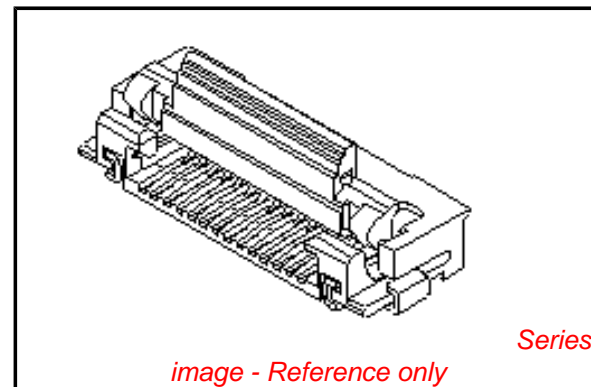

*image - Reference only*

**EU RoHS**

**ELV and RoHS  
Compliant**  
**REACH SVHC  
Contains SVHC: No  
Low-Halogen Status  
Not Low-Halogen**

**China RoHS**



**Need more information on product  
environmental compliance?**

Email [productcompliance@molex.com](mailto:productcompliance@molex.com)  
 For a multiple part number RoHS Certificate of Compliance, [click here](#)

Please visit the [Contact Us](#) section for any non-product compliance questions.

**Search Parts in this Series**

[52892Series](#)

This document was generated on 03/08/2013

**PLEASE CHECK [WWW.MOLEX.COM](http://WWW.MOLEX.COM) FOR LATEST PART INFORMATION**

# Mouser Electronics

Authorized Distributor

Click to View Pricing, Inventory, Delivery & Lifecycle Information:

[Molex:](#)

[52892-1295](#)