

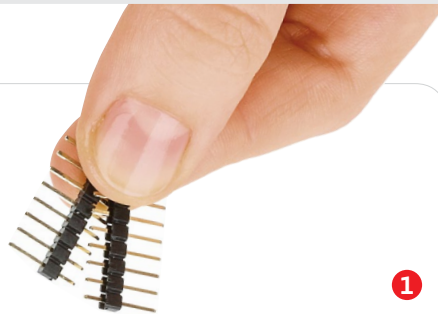

## EXPAND 2 click™

### 2. Soldering the headers

Before using your click™ board, make sure to solder 1x8 male headers to both left and right side of the board. Two 1x8 male headers are included with the board in the package.



1

2

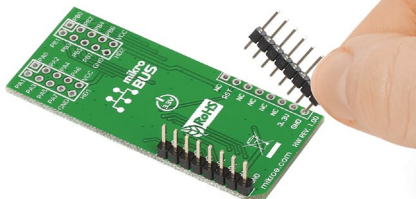

Turn the board upside down so that the bottom side is facing you upwards. Place shorter pins of the header into the appropriate soldering pads.

3

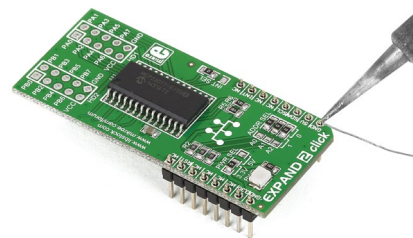

Turn the board upward again. Make sure to align the headers so that they are perpendicular to the board, then solder the pins carefully.

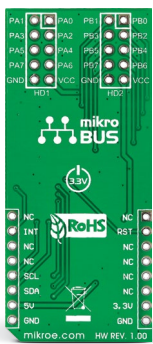
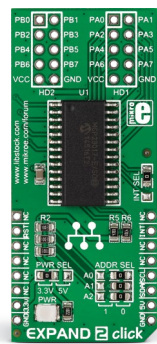

### 1. Introduction

EXPAND 2 click™ is an accessory board in mikroBUS™ form factor. It includes a 16-bit I/O expander MCP23017 with I<sup>2</sup>C clock speeds of 100 kHz, 400 kHz, or 1.7 MHz for higher throughput applications. Three HARDWARE ADDRESS SEL jumpers allow you to configure board address and connect up to eight devices on the bus. Controller also supports interrupt-on-change. Board is set to use 3.3V power supply by default. Solder PWR SEL SMD jumper to 5V position if used with 5V systems.

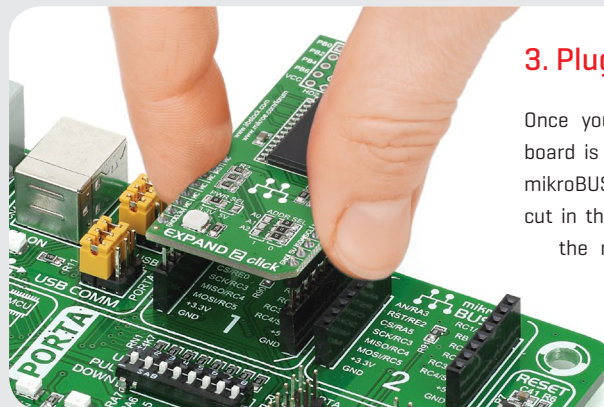

### 3. Plugging the board in

Once you have soldered the headers your board is ready to be placed into the desired mikroBUS™ socket. Make sure to align the cut in the lower-right part of the board with the markings on the silkscreen at the mikroBUS™ socket. If all the pins are aligned correctly, push the board all the way into the socket.

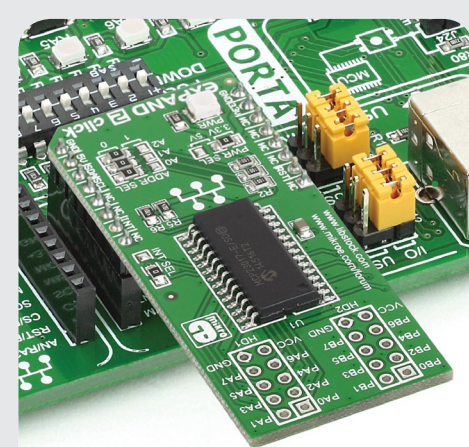

### 4. Essential features

Communication with on-board port expander is done through I<sup>2</sup>C communication interface. The 16 I/O port bits are divided into two 8-bit ports [marked HD1 and HD2]. The MCP23017 can be configured to operate in the 8-bit or 16-bit mode. All pins act as bidirectional I/Os and can be enabled for interrupt-on-change and/or internal weak pull-up resistor.

click™  
BOARD  
[www.mikroe.com](http://www.mikroe.com)



EXPAND 2 click™ manual  
ver 1.00



010000074732

## 5. Schematic

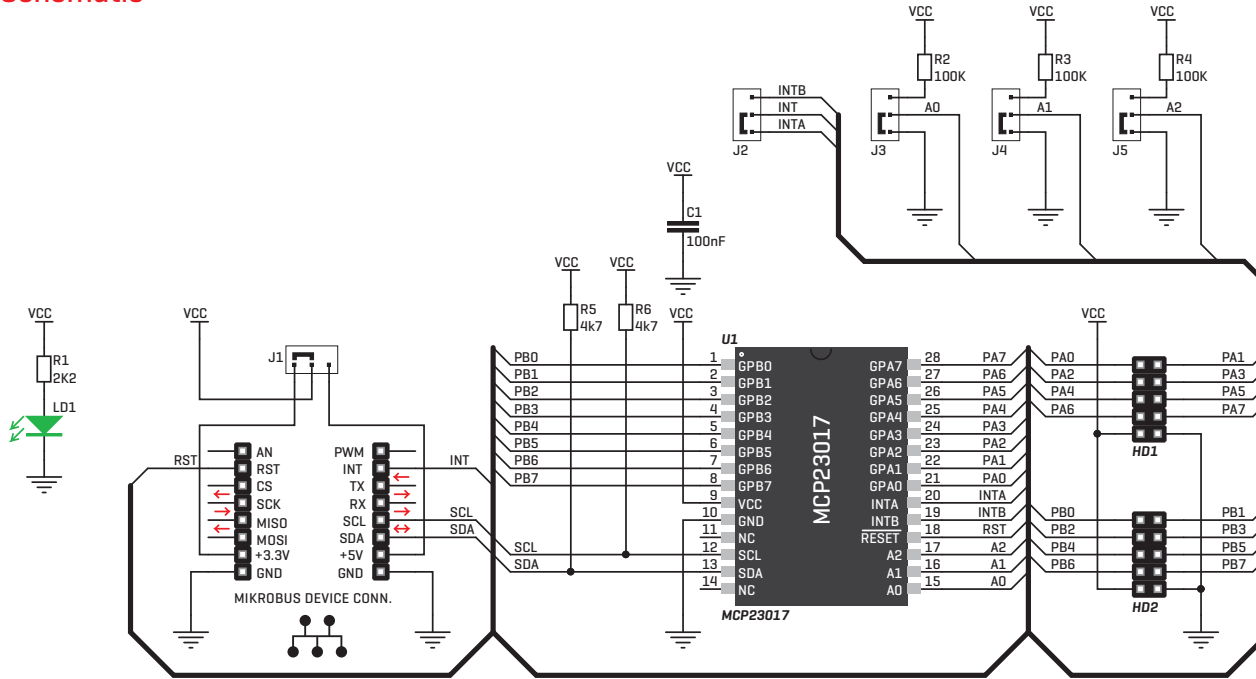

## 6. Dimensions

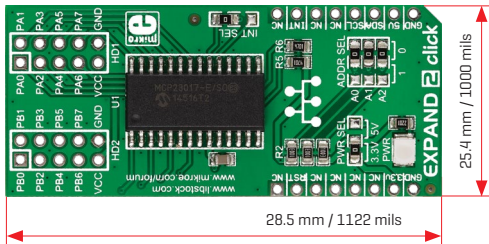

	mm	mils
LENGTH	57	2244
WIDTH	25.4	1000
HEIGHT*	3.2	157.5

\* without headers

## 7. SMD jumpers

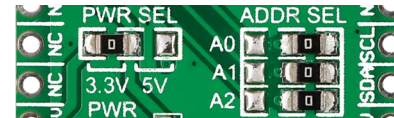

There are four zero-ohm resistors [SMD jumpers]: **PWR SEL** is used to determine whether 5V or 3.3V power supply is used, and three hardware **ADDR SEL** for selecting the device address.

## 8. Code examples

Once you have done all the necessary preparations, it's time to get your click™ board up and running. We have provided examples for mikroC™, mikroBasic™ and mikroPascal™ compilers on our **Libstock** website. Just download them and you are ready to start.



## 9. Support

MikroElektronika offers **free tech support** [[www.mikroe.com/support](http://www.mikroe.com/support)] until the end of the product's lifetime, so if something goes wrong, we're ready and willing to help!



## 10. Disclaimer

MikroElektronika assumes no responsibility or liability for any errors or inaccuracies that may appear in the present document. Specification and information contained in the present schematic are subject to change at any time without notice.

Copyright © 2015 MikroElektronika.  
All rights reserved.

# Mouser Electronics

Authorized Distributor

Click to View Pricing, Inventory, Delivery & Lifecycle Information:

[Mikroe:](#)

[MIKROE-1838](#)