

Founded in 1945, Weller has become the world's leading supplier of professional quality soldering equipment, including the famous Weller temperature controlled irons and soldering guns. Weller also makes advanced soldering and desoldering stations, SMT equipment and irons for sophisticated industrial requirements, plus a series of handy soldering kits for home craftsmen, hobbyists and light industry.

IMPORTANT NOTE

Just click on the
item you want.



Contents

MicroTouch Plus™ (MT) soldering stations

Electronically controlled (EC) soldering stations

Irons for electronically controlled soldering stations

Weller®/Ungar® Electronic soldering system

Controlled-output soldering stations

Stained glass station

Controlled-output soldering irons

Professional soldering irons

Weller®/Ungar® Pro Plus™ series soldering irons

Temtronic soldering pencil

Marksman® soldering irons

Cordless soldering tools

Solder fume extraction systems

Soldering stations with fume extraction irons

Irons for fume extraction systems

Weller® fume extraction adapter table

Desoldering stations

Weller® Temperature controlled rework stations

Manual desoldering tools

Surface mount products

Accessory products-electronic soldering stations

Accessory products-iron stands

Accessory products-miscellaneous

Tips for electronic soldering stations

Tips for controlled output soldering irons

Tips for professional soldering irons

Tips for surface mount products

Tips for Marksman® soldering tools

Tips for cordless soldering tools

Tiploters for desoldering tools

Desoldering accessories for Surface Mount Technology (SMT)

Consumer products

查询"53002699"供应商

Weller[®]

| | PRODUCTION | MRO & SERVICE | DESOLDERING REWORK | HOT AIR | SURFACE MOUNT | MIL SPEC | ESD | TEST | DISPENSING | CORDLESS | LOCKOUT | FUME REMOVAL | HOBBYIST |
|--------------|------------|---------------|-----------------------|---------|---------------|----------|-----|------|------------|----------|---------|--------------|----------|
| EC2002M | • | | | | • | • | • | | | | | | |
| EC1002 | • | | | | • | • | • | | | | | | |
| WTL1000 | • | | | | • | • | • | | | • | | | |
| DEC1001 | • | • | • | | • | • | • | | | | | | |
| DTL1000 | • | • | • | | • | • | • | | | • | | | |
| WTCPT | • | • | | | • | | • | | | • | | | |
| Fume Extract | | | | | | | | | | | | • | |
| DS800 | | | • | | | • | • | | | | | | |
| DS700M | | • | • | | | | | | | | | | |
| DS600 | | | • | | | | | | | | | | |
| MT1500(L) | • | • | | | • | | • | | | • | | | |
| WRS3000 | | | • | • | • | • | • | | | • | | | |
| WRS2000 | | | • | • | • | • | • | • | | | | | |
| WRS1000 | | | • | • | • | • | • | | | | | | |
| AG75 | | | | • | • | | | | | | | | |
| WA2000 | | | | | | | | • | | | | | |
| WCC100 | | • | | | | | | | | | | | • |
| 7200PK | | | | | | | | | | | | | • |
| 8200 | | | | | | | | | | | | | • |
| D550 | | • | | | | | | | | | | | • |
| P1 | | | | | | | | • | | | | | |
| WPA2 | | | | | | | | | • | | | | |
| WLC100 | | | | | | | | | | | | | • |
| WLC200 | | | | | | | | | | | | | • |
| WHA700 | | | • | • | • | • | • | | | | | | |
| WHA2000 | | | • | • | • | • | • | | | | | | |

The simple answer to high quality, versatile ESD safe soldering.

Enter the new age of ESD safe soldering with Weller®. Weller's new blue family of high precision soldering equipment is recognized throughout the industry as the most sophisticated and versatile, whether applied to electronic and industrial needs, high volume assembly, rework or repair.

Now, Weller makes soldering selection easier. Weller has taken five popular stations and three irons from which the optimal soldering work stations can be selected. Various station/iron combinations can be applied to endless soldering jobs... that means more versatility.

Reliable Weller quality is built into each compact unit which has its own extremely accurate temperature control system. All casings are made of durable electrostatic protective material in unique Weller blue. The iron stand may be used separately from the main power unit or attached to either side for easy use by left or right hand. The stand has a water reservoir and storage space for six tips. Plus, the antistatic iron cord has flexible cord guard to extend cord life.

Every station is 100% quality inspected!

MicroTouch Plus™ Soldering Station MT1500, MT1500L



- Immediate, accurate tip temperature for faster soldering - (MT202-3 seconds)
- Quick tip change system, no tools required
- Expanded tip selection - .010 point to PLCC68 (over 50 available)
- Touch feature for extended tip life - reduces operating cost
- Excellent thermal capacity - improves performance in all applications
- Immediate response to thermal loads - improves productivity
- Complete control with adjustable temperature and digital display
- Three basic Modes:
 - Touch Mode: Intended for soldering very small components with microtips
 - Idle Mode: Similar to Touch Mode, but uses large tips
 - Continuous Mode: Suited for very large surface mount device tips
- Average tip temperature is calibrated to $\pm 9^{\circ}\text{F}$ ($\pm 5^{\circ}\text{C}$) at idle with no load
- Tip temperature range 400°F to 800°F (204°C to 427°C)
- Stability $\pm 10^{\circ}\text{F}$ ($\pm 6^{\circ}\text{C}$)
- Control setting resolution 1°F (1°C)
- Unit not provided with tip - Tips to be purchased separately
- MT series tips listed on page Weller 58

| Cat. No. | UPC No. | Description | V | W | Hz | Shelf Pack Wt. | | Shelf Pack |
|---|--------------|---|-----|-----|----|----------------|-----|------------|
| | | | | | | lb | kg | |
| MT1500 | 037103108883 | Complete station w/o tip | 120 | 150 | 60 | 7.4 | 3.4 | 1 |
| MT1500L | 037103127761 | Complete station w/o tip, with operator lockout | 120 | 150 | 60 | 7.4 | 3.4 | 1 |
| The following is available only to authorized export distributors. Units not VDE or GS approved. | | | | | | | | |
| MT1500D | 037103110794 | Complete station w/o tip | 230 | 150 | 60 | 7.4 | 3.4 | 1 |

Electronic controlled (EC) soldering stations EC2002M

Weller®

 [查询"53002699"供应商](#)

ESD SAFE

- LED readout displays temperature settings and tip temperature with a resolution of 1°F (1°C) and stability of ±10°F (±6°C)
- Display shows "Read" mode by default which displays current temperature of the tip
- To switch to "Set" mode, turn knob slightly, display will show current set temperature
- Handles delicate applications
- Electrostatic discharge safe (ESD safe)
- Available with 40, 20 or 42 watt iron stand, with tip storage, positions left, right or remote from main unit
- Water reservoir keeps sponge moist
- SPEC. COMPLIANCE: DOD-STD-2000, Mil-STD-2000, Mil-S-45743, W-S-6536, W-S-570 and DOD-STD-1686
- Externally fused
- See iron fume extraction adapter kit table on page Weller 27
- UL listed and FCC approved



Optional Features Available (Using WCM-1 Calibrator, See page Weller 43)

- Calibrator to factory reset or custom offset
- Lockout provides temperature lockout on a variable temperature station
- Set back feature provides operator determination set back timing to 350°F/Automatic 99 minute station shut down

| Cat. No. | UPC No. | Description | V | W | Hz | Shelf Pack Wt. | | Shelf Pack |
|---|--------------|---|-----|----|-------|----------------|------|------------|
| | | | | | | lb | kg | |
| EC2002M0 | 037103103284 | Power unit-24V Output | 120 | 60 | 60 | 3.75 | 1.69 | 1 |
| EC2002M1 | 037103103291 | Complete station w/EC1201Airon & stand | | | | 4.00 | 1.80 | 1 |
| EC2002M2 | 037103103260 | Complete station w/EC1302Airon & stand | | | | 3.75 | 1.69 | 1 |
| EC2002M3 | 037103103277 | Complete station w/EC1503Airon & stand | | | | 3.75 | 1.69 | 1 |
| The following is available only to authorized export distributors. Units not VDE or GS approved. | | | | | | | | |
| EC2002M0D | 037103000552 | Power unit only | 240 | 60 | 50/60 | 3.75 | 1.69 | 1 |
| EC2002M1D | 037103000569 | Complete station w/EC1201A iron & stand | | | | 4.00 | 1.80 | 1 |
| EC2002M2D | 037103000576 | Complete station w/EC1302Airon & stand | | | | 4.00 | 1.80 | 1 |
| EC2002M3D | 037103000583 | Complete station w/EC1503A iron & stand | | | | 4.00 | 1.80 | 1 |



Station No.: **EC2002M1**
EC1201A 40w iron w/ETA tip & stand.
Tips listed on page Weller 57.



Station No.: **EC2002M2**
EC1302A 20w iron w/EPH101 tip & stand.
Tips listed on page Weller 60.



Station No.: **EC2002M3**
EC1503A 42w iron w/EMA tip & stand.
Tips listed on page Weller 61.

EC1002



[查询"53002699"供应商](#)

ESD SAFE



- Dial calibrated in 10°F (6°C) increments
- Power control with zero cross switching for tips free of high voltage spikes
- Electrostatic discharge safe (ESD safe)
- True protection for sensitive, electronic components
- Available with 40, 20 or 42 watt iron
- Iron stand, with tip storage, positions left, right or remote from main unit
- SPEC. COMPLIANCE: DOD-STD-2000, Mil-STD-2000, Mil-S-45743, W-S-6536, W-S-570 and DOD-STD-1686
- Unit allows external calibration by user
- Externally fused
- See iron fume extraction adapter kit table on page Weller 27
- UL listed

| Cat. No. | UPC No. | Description | V | W | Hz | Shelf Pack Wt. | | Shelf Pack |
|---|--------------|---|-----|----|-------|----------------|------|------------|
| | | | | | | lb | kg | |
| EC10020 | 037103000514 | Power unit-24V Output | 120 | 60 | 60 | 3.75 | 1.69 | 1 |
| EC10021 | 037103000439 | Complete station w/EC1201A iron & stand | | | | 4.00 | 1.80 | 1 |
| EC10022 | 037103000446 | Complete station w/EC1302A iron & stand | | | | 4.00 | 1.80 | 1 |
| EC10023 | 037103000453 | Complete station w/EC1503A iron & stand | | | | 4.00 | 1.80 | 1 |
| The following is available only to authorized export distributors. Units not VDE or GS approved. | | | | | | | | |
| EC10020D | 037103000521 | Power unit only | 240 | 60 | 50/60 | 3.75 | 1.69 | 1 |
| EC10021D | 037103000491 | Complete station w/EC1201A iron & stand | | | | 4.00 | 1.80 | 1 |
| EC10022D | 037103000507 | Complete station w/EC1302A iron & stand | | | | 4.00 | 1.80 | 1 |
| EC10023D | 037103000538 | Complete station w/EC1503A iron & stand | | | | 4.00 | 1.80 | 1 |



Station No.: **EC10021**
EC1201A 40w iron w/ETA tip & stand.
 Tips listed on page Weller 57.

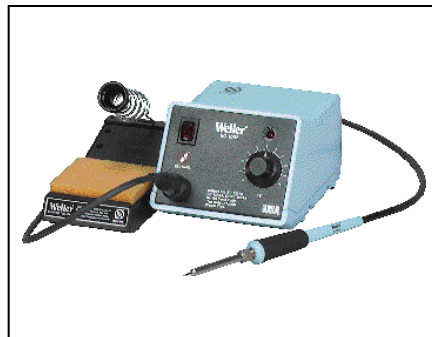

Station No.: **EC10022**
EC1302A 20w iron w/EPH101 tip & stand.
 Tips listed on page Weller 60.



Station No.: **EC10023**
EC1503A 42w iron w/EMAtip & stand.
 Tips listed on page Weller 61.



- Tip temperature controlled by Thermolock® “keys” - PROVIDES OPERATOR LOCKOUT
- Tip temperature automatically set to within ±10°F with Thermolock® “key” installed
- Safety feature powers iron down to 350°F if “key” is removed while unit is on
- Electrostatic discharge safe (ESD safe)
- For use with 40, 20, 42 watt irons
- Iron stand, with tip storage, positions left, right or remote from main unit
- SPEC. COMPLIANCE: DOD-STD-2000, Mil-STD-2000, Mil-S-45743, W-S-6536, W-S-570 and DOD-STD-1686
- Unit allows calibration by user
- 700°F, 750°F, 800°F temperature keys included
- Externally fused
- See iron fume extraction adapter kit table on page Weller 27
- UL listed

[查询"53002689"供应商](#)



| Cat. No. | UPC No. | Description | V | W | Hz | Shelf Pack Wt. | | Shelf Pack |
|----------|--------------|--|-----|----|----|----------------|------|------------|
| | | | | | | lb | kg | |
| WTL10000 | 037103593276 | Power unit-24V Output | 120 | 60 | 60 | 3.75 | 1.69 | 1 |
| WTL10001 | 037103593221 | Complete station w/EC1201Airon & stand | | | | 4.00 | 1.80 | 1 |
| WTL10002 | 037103593238 | Complete station w/EC1302Airon & stand | | | | 4.00 | 1.80 | 1 |
| WTL10003 | 037103593245 | Complete station w/EC1503Airon & stand | | | | 4.00 | 1.80 | 1 |

The following is available only to authorized export distributors. Units not VDE or GS approved.

| | | | | | | | | |
|-----------|--------------|--|-----|----|-------|------|------|---|
| WTL10000D | 037103027429 | Power unit only | 240 | 60 | 50/60 | 3.75 | 1.69 | 1 |
| WTL10001D | 037103024701 | Complete station w/EC1201Airon & stand | | | | 4.00 | 1.80 | 1 |
| WTL10002D | 037103024718 | Complete station w/EC1302Airon & stand | | | | 4.00 | 1.80 | 1 |
| WTL10003D | 037103027436 | Complete station w/EC1503Airon & stand | | | | 4.00 | 1.80 | 1 |

| Cat. No. | UPC No. | Description | Shelf Pack | Color Code | Temp °F | For Soldering Tip Style |
|----------|--------------|-----------------|------------|------------|---------|-----------------------------------|
| TL600A | 037103593252 | Temperature key | 1 | White | 600 | ETA, ETAA, ETB, ETBB, ETC, ETCC |
| TL650A | 037103593016 | Temperature key | 1 | White | 650 | ETD, ETDD, ETH, ETP |
| TL700A | 037103593023 | Temperature key | 1 | White | 700 | EPH101, EPH102, EPH103, EPH104 |
| TL750A | 037103592910 | Temperature key | 1 | White | 750 | EPH107, EPH108, EPH109, EPH110 |
| TL800A | 037103592927 | Temperature key | 1 | White | 800 | EMA, EMB, EMH, EMX |
| TL850A | 037103592996 | Temperature key | 1 | White | 850 | |
| TL600B | 037103593009 | Temperature key | 1 | Yellow | 600 | ETZ, ETM, ETR, ETU |
| TL650B | 037103592972 | Temperature key | 1 | Yellow | 650 | EMC, EMD, EME, EMF, EMG, EMY |
| TL700B | 037103592989 | Temperature key | 1 | Yellow | 700 | EPH105, EPH106, EPH111 |
| TL750B | 037103592897 | Temperature key | 1 | Yellow | 750 | SMT89J, SMT8K |
| TL800B | 037103592903 | Temperature key | 1 | Yellow | 800 | SMT0504A, SMT0805B, SMT1005C |
| TL850B | 037103592958 | Temperature key | 1 | Yellow | 850 | SMT1206D, SMT1808F, SMT80M, SMT2E |
| TL600C | 037103592965 | Temperature key | 1 | Red | 600 | ETJ, ETK, ETO, ETS, ETT |
| TL650C | 037103592934 | Temperature key | 1 | Red | 650 | ETY |
| TL700C | 037103592941 | Temperature key | 1 | Red | 700 | SMT1505E, SMT1825G, SMT14L |
| TL750C | 037103592873 | Temperature key | 1 | Red | 750 | |
| TL800C | 037103592880 | Temperature key | 1 | Red | 800 | |
| TL850C | 037103592859 | Temperature key | 1 | Red | 850 | |



Station No.: **WTL10001**
EC1201A 40w iron w/ETA tip & stand.
 Tips listed on page Weller 57.



Station No.: **WTL10002**
EC1302A 20w iron w/EPH101 tip & stand.
 Tips listed on page Weller 60.



Station No.: **WTL10003**
EC1503A 42w iron w/EMAtip & stand.
 Tips listed on page Weller 61.

DEC1001



[查询"53002699"供应商](#)

ESD SAFE



- Combined power of two temperature controlled stations in one
- Dual dial temperature range of 350°F to 850°F
- Ideal for multiple use situations-Power unit output: 24VAC
- For use with 40, 20 or 42 watt irons combining any two at a time. IRONS SOLD SEPARATELY
- Electrostatic discharge safe (ESD safe)
- Two iron stands included with tip storage, positions left, right or remote from main unit
- Water reservoir keeps sponge moist
- SPEC. COMPLIANCE - DOD-STD-2000, Mil-STD-2000, Mil-S-45743, W-S-6536, W-S-570 and DOD-STD-1686
- DEC1001 Comes with stand no. PH1201ESD & PH1301 ESD
- Unit allows calibration by user
- Externally fused
- See iron fume extraction adapter kit table on page Weller 27
- UL listed

| Cat. No. | UPC No. | Description | V | W | Hz | Shelf Pack Wt. | | Shelf Pack |
|----------|--------------|--|-----|-----|----|----------------|------|------------|
| | | | | | | lb | kg | |
| DEC1001 | 037103593030 | Dual iron power unit w/two iron stands | 120 | 120 | 60 | 3.75 | 1.69 | 1 |



Station No.: **DEC1000**



- Combines power of two temperature controlled stations in one
- Tip temperature for both irons controlled by Thermolock® “keys” not adjustable by the operator - PROVIDES OPERATOR LOCKOUT
- To change tip temperature, replace one “key” with another “key” marked with a different temperature
- Tip temperature controls to within ±10°F with inserted Thermolock® “key”
- Electrostatic discharge safe (ESD safe)
- Safety feature powers down to 350°F if “key” is removed while unit is on
- Ideal for multiple use situations - Power unit output 24VAC
- For use with 40, 20, 42 watt irons, combining any two at a time - **IRONS SOLD SEPARATELY**
- DTL1000 comes with stand no. PH1201ESD and PH1301ESD
- SPEC. COMPLIANCE: DOD-STD-2000, Mil-STD-2000, W-S-6536, W-S-570 and DOD-STD-1686
- Unit allows calibration by user
- Externally fused
- See iron fume extraction adapter kit table on page Weller 27
- UL listed
- 2 ea. of 700°F, 750°F, 800°F temperature keys included

查询"53002699"供应商



| Cat. No. | UPC No. | Description | V | W | Hz | Shelf Pack Wt. | | Shelf Pack |
|----------|--------------|--|-----|-----|----|----------------|------|------------|
| | | | | | | lb | kg | |
| DTL1000 | 037103028174 | Dual iron power unit w/two iron stands | 120 | 120 | 60 | 3.75 | 1.69 | 1 |

| Cat. No. | UPC No. | Description | Shelf Pack | Color Code | Temp °F | For Soldering Tip Style |
|----------|--------------|-----------------|------------|------------|---------|-----------------------------------|
| TL600A | 037103593252 | Temperature key | 1 | White | 600 | ETA, ETAA, ETB, ETBB, ETC, ETCC |
| TL650A | 037103593016 | Temperature key | 1 | White | 650 | ETD, ETDD, ETH, ETP |
| TL700A | 037103593023 | Temperature key | 1 | White | 700 | EPH101, EPH102, EPH103, EPH104 |
| TL750A | 037103592910 | Temperature key | 1 | White | 750 | EPH107, EPH108, EPH109, EPH110 |
| TL800A | 037103592927 | Temperature key | 1 | White | 800 | EMA, EMB, EMH, EMX |
| TL850A | 037103592996 | Temperature key | 1 | White | 850 | |
| TL600B | 037103593009 | Temperature key | 1 | Yellow | 600 | ETZ, ETM, ETR, ETU |
| TL650B | 037103592972 | Temperature key | 1 | Yellow | 650 | EMC, EMD, EME, EMF, EMG, EMY |
| TL700B | 037103592989 | Temperature key | 1 | Yellow | 700 | EPH105, EPH106, EPH111 |
| TL750B | 037103592897 | Temperature key | 1 | Yellow | 750 | SMT89J, SMT8K |
| TL800B | 037103592903 | Temperature key | 1 | Yellow | 800 | SMT0504A, SMT0805B, SMT1005C |
| TL850B | 037103592958 | Temperature key | 1 | Yellow | 850 | SMT1206D, SMT1808F, SMT80M, SMT2E |
| TL600C | 037103592965 | Temperature key | 1 | Red | 600 | ETJ, ETK, ETO, ETS, ETT |
| TL650C | 037103592934 | Temperature key | 1 | Red | 650 | ETY |
| TL700C | 037103592941 | Temperature key | 1 | Red | 700 | SMT1505E, SMT1825G, SMT14L |
| TL750C | 037103592873 | Temperature key | 1 | Red | 750 | |
| TL800C | 037103592880 | Temperature key | 1 | Red | 800 | |
| TL850C | 037103592859 | Temperature key | 1 | Red | 850 | |



Station No.: **DTL1000**

Irons for Electronically Controlled soldering stations

EC1201A



[查询"53002699"供应商](#)



- General purpose soldering tool
- Specifically designed for use at electrostatic discharge free work stations
- Completely free from stored static charges (ESD safe)
- Stainless steel plug-in heater element construction
- Non-burnable silicon rubber cord
- Lightweight, high impact plastic handle
- Blue plastic meets requirements for ESD, ELECTROSTATIC DISSIPATIVE MATERIALS
- Weller station and iron combination meets: DOD-STD-2000, Mil-STD-2000, Mil-S-45743, W-S-570 and DOD-STD-1686
- Uses Weller ET and SMT series tips made of copper w/heavy iron, nickel and chromium plating for long life
- IMPORTANT: Use only Weller tips
- ET series tips on page Weller 57
- SMT series tips on page Weller 66
- See iron fume extraction adapter kit table on page Weller 27
- UL listed

| Cat. No. | UPC No. | Description | V | W | Hz | Shelf Pack Wt. | | Shelf Pack |
|--------------------------|--------------|------------------------------|----|----|----|----------------|------|------------|
| | | | | | | lb | kg | |
| EC1201A | 037103593795 | 40w soldering iron w/ETA tip | 24 | 40 | - | 0.37 | 0.16 | 1 |
| Replacement parts | | | | | | | | |
| EC234 | 037103479747 | Heater assembly for EC1201A | | | | - | | 1 |
| EC229A | 037103594044 | Sensor assembly for EC1201A | | | | - | | 1 |



Catalog No.: **PH1201ESD**
Iron stand assembly



Catalog No.: **TC204**
Spring and funnel assembly



Catalog No.: **TC205**
Sponge



[查询"53002699"供应商](#)



- Micro-soldering tool
- Specifically designed for use at electrostatic free work stations
- Completely free from stored static charges (ESD safe)
- Stainless steel heater element construction
- Non-burnable silicon rubber cord
- Lightweight, high impact plastic handle
- Blue plastic meets requirements for ESD, ELECTROSTATIC DISSIPATIVE MATERIALS
- Weller station and iron combination meets: DOD-STD-2000, Mil-STD-2000, Mil-S-45743, W-S-6536, W-S-570 and DOD-STD-1686
- Uses Weller EPH series tips made of copper w/heavy iron, nickel and chromium plating for long life
- IMPORTANT: Use only Weller tips
- EPH series tips on page Weller 60
- See iron fume extraction adapter kit table on page Weller 27
- UL listed

| Cat. No. | UPC No. | Description | V | W | Hz | Shelf Pack Wt. | | Shelf Pack |
|--------------------------|--------------|-----------------------------|----|----|----|----------------|------|------------|
| | | | | | | lb | kg | |
| EC1302A | 037103593290 | 20w iron w/EPH101 tip | 24 | 20 | - | 0.31 | 0.14 | 1 |
| Replacement parts | | | | | | | | |
| EC259 | 037103032478 | Heater assembly for EC1302A | | | | - | | 1 |
| EC260 | 037103032485 | Sensor assembly for EC1302A | | | | - | | 1 |



Catalog No.: **PH1301ESD**
Iron stand assembly



Catalog No.: **IHF225EC**
Spring and funnel assembly



Catalog No.: **TC205**
Sponge

EC1503A



[查询"53002699"供应商](#)

ESD SAFE



- Tool designed for difficult applications such as multilayer boards, large heat output from small tool
- Specifically designed for use at electrostatic free work stations
- Completely free from static charges (ESD safe)
- Non-burnable silicon rubber cord
- Lightweight, high impact plastic handle
- Blue plastic meets requirements for ESD, ELECTROSTATIC DISSIPATIVE MATERIALS
- High mass EM series tips manufactured w/taper fit to match iron heater sheath providing max. heat transfer from heater to tip. 14 tip shapes available
- Weller station and iron combination meets: DOD-STD-2000, Mil-STD-2000, Mil-S-45743, W-S-6536, W-S-570 and DOD-STD-1686
- Uses Weller EM series tips made of copper w/heavy iron, nickel and chromium plating for long life
- IMPORTANT: Use only Weller tips
- EM series tips on page Weller 61
- See iron fume extraction adapter kit table on page Weller 27
- UL listed

| Cat. No. | UPC No. | Description | V | W | Hz | Shelf Pack Wt. | | Shelf Pack |
|--------------------------|--------------|-----------------------------|----|----|----|----------------|------|------------|
| | | | | | | lb | kg | |
| EC1503A | 037103593283 | 42w soldering iron w/EMAtip | 24 | 42 | - | 0.31 | 0.14 | 1 |
| Replacement parts | | | | | | | | |
| EC262 | 037103032461 | Heater assembly for EC1503A | | | | - | | 1 |
| EC263 | 037103032447 | Sensor assembly for EC1503A | | | | - | | 1 |



Catalog No.: **PH1503**
Iron stand assembly



Catalog No.: **EC254**
Spring and funnel assembly



Catalog No.: **TC205**
Sponge

Weller/Unger electronic soldering system 921ZX1

Weller®



[查询"53002699"供应商](#)

- Electronically controlled - zero cross circuitry
- Spike free - ESD safe
- Ceramic heater rated for exceptionally long life
- Variable control - fully adjustable 550° - 850°F
- Lightweight hand piece
- Over 39 tips available including SMT tips
- External fuse and calibration access
- Temperature lockout available
- Small footprint requires little bench space
- Mil-STD compliant
- Replace tips listed on page Unger 20 (9000 series)
- UL listed



| Cat. No. | UPC No. | Description | V | W | Hz | Shelf Pack Wt. | | Shelf Pack |
|---|--------------|----------------------------|-----|-----|-------|----------------|------|------------|
| | | | | | | lb | kg | |
| 921ZX1 | 037103089281 | Soldering station/9018 tip | 120 | 60* | 60 | 3.7 | 1.68 | 1 |
| The following is available only to authorized export distributors. Units not VDE or GS approved. | | | | | | | | |
| 921ZX1D | 037103095114 | Soldering station/9018 tip | 230 | 60* | 50/60 | 3.7 | 1.68 | 1 |

* Handle wattage is rated at full load. Idle wattage is approximately 20 watts.

| Cat. No. | UPC No. | Description | Shelf Pack Wt. | | Shelf Pack |
|----------|--------------|---|----------------|-------|------------|
| | | | lb | kg | |
| 9904 | 037103035455 | Replacement sponge | 0.01 | 0.005 | 10 |
| 2115 | 037103031624 | Temperature lockout kit | 0.075 | 0.034 | 1 |
| 9908 | 037103035486 | Replacement heating element | 0.027 | 0.012 | 1 |
| 9037 | 037103035042 | Tip retainer assembly for standard tips | 0.03 | 0.014 | 1 |
| 9919 | 037103035578 | Tip retainer assembly for thermal thrust tips | 0.03 | 0.014 | 1 |
| 4618 | 037103063434 | Tip adapter for Weller® SMT tips | 0.02 | 0.009 | 2 |



Catalog No.: **9211**
Iron for 921ZX1 w/9018 tip



Catalog No.: **9904**
Sponge for 921ZX1

Controlled-output soldering station WTCPT

[查询"53002699"供应商](#)



- Transformer powered soldering station complete w/macro style, low voltage, temperature controlled soldering iron
- Special "closed loop" method of controlling maximum tip temperature... to protect temperature sensitive components
- Power unit housing features impact resistant plastic for durability
- Quick disconnect plug for soldering iron and lighted on/off switch
- Separate conductor grounds iron tip and terminates at third pin of power cord
- PT series soldering tips come in a variety of shapes and sizes in three standard temperature ranges: 600°F, 700°F and 800°F. Optional temperatures for special order 500°F and 900°F
- PT series tips listed on page Weller 62
- See iron fume extraction adapter kit table on page Weller 27
- UL listed

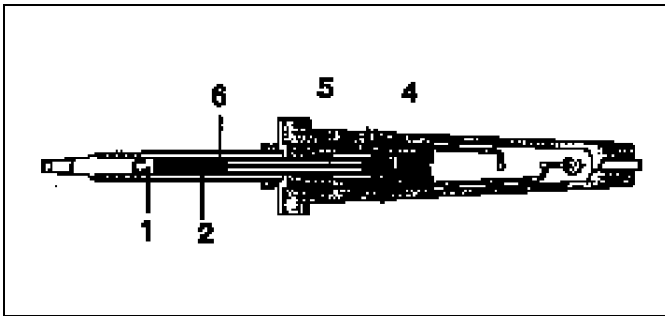

When the soldering tip is cold, a ferromagnetic temperature sensor (1) attached to the tip attracts a permanent magnet (2). The magnet movement causes a shorting bar (3) to make contact with a set of isolated electrical contacts (4) thereby supplying power to the heating element through the solder lugs (5). When the tip reaches its idle temperature, the sensor becomes non-magnetic and no longer attracts the magnet. Then a magnetic bushing (6) attracts the magnet causing the shorting bar to break the circuit. In this manner, power to the heating element is turned on and off automatically.

| Cat. No. | UPC No. | Description | V | W | Hz | Shelf Pack Wt. | | Shelf Pack |
|---|--------------|-----------------------------|-----|----|-------|----------------|------|------------|
| | | | | | | lb | kg | |
| WTCPT | 037103001146 | Complete station-24V Output | 120 | 60 | 60 | 4.00 | 1.80 | 1 |
| TC201T | 037103001153 | Soldering iron | 24 | 42 | | 0.31 | 0.14 | 1 |
| The following is available only to authorized export distributors. Units not VDE or GS approved. | | | | | | | | |
| WTCPTD | 037103001122 | Complete station | 240 | 60 | 50/60 | 4.00 | 1.80 | 1 |
| Replacement parts | | | | | | | | |
| EC234 | 037103479747 | Heater assembly for TC201T | | | | | | 1 |
| SW60 | 037103474040 | Switch assembly for TC201T | | | | | | 1 |

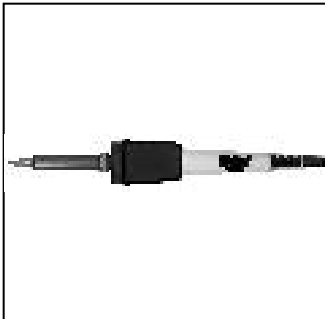

Catalog No.: **TC201T**
42w iron w/PTA7 tip



Catalog No.: **PH1201ESD**
ESD Iron stand assembly



Catalog No.: **TC204**
Spring and funnel assembly



Catalog No.: **TC205**
Sponge

Stained glass station WLC200

[查询"53002699"供应商](#)

- On/off switch with "power-on" indicator light
- Variable power control produces 5-80 watts
- Quality lightweight stained glass iron
- Cushioned foam grip with replaceable heating element
- Ideal for the professional or hobbyist
- Safety guard iron holder
- Natural sponge tip cleaning pad
- 3/8 in. replaceable tip
- Operates with MTG20, MTG21 MTG22 tips, see page Weller 68
- See iron fume extraction adapter kit table on page Weller 27
- UL listed



| Cat. No. | UPC No. | Description | V | W | Hz | Shelf Pack Wt. | | Shelf Pack |
|----------|--------------|-----------------------------|-----|----|----|----------------|------|------------|
| | | | | | | lb | kg | |
| WLC200 | 037103085030 | Complete station w/80w iron | 120 | 80 | 60 | 2.5 | 1.13 | 1 |

Controlled-output soldering irons W60P series irons



- Line voltage high quality portable tool... controlled output and temperature
- Weller "closed loop" method of controlling max. tip temperature protects temperature sensitive components
- Iron features stainless steel modular plug-in heater construction for greater soldering efficiency
- Nominal heat-up time w/CT5A7 tip = 110 seconds
- Includes CT5A7, 700°F 1/16" dia. screwdriver tip
- Also available with 3-wire grounded cord set
- **IMPORTANT:** Use only Weller tips
- CT5 series tips listed on page Weller 63
- See iron fume extraction adapter kit table on page Weller 27
- UL listed

| Cat. No. | UPC No. | Description | V | W | Hz | Shelf Pack Wt. | | Shelf Pack |
|----------|--------------|--------------------------------|-----|----|-------|----------------|------|------------|
| | | | | | | lb | kg | |
| W60P | 037103474087 | Soldering iron w/CT5A7 tip | 120 | 60 | 50/60 | 4.00 | 1.80 | 6 |
| W60P3 | 037103474094 | Same as W60P but w/3-wire cord | 120 | 60 | 50/60 | 4.00 | 1.80 | 6 |

The following is available only to authorized export distributors. Units not VDE or GS approved.

| | | | | | | | | |
|--------|--------------|----------------------------|-----|----|-------|------|------|---|
| W60PD | 037103477811 | Soldering iron | 240 | 60 | 50/60 | 4.00 | 1.80 | 6 |
| W60PD3 | 037103593962 | Soldering iron 3-wire cord | 240 | 60 | 50/60 | 4.00 | 1.80 | 6 |

Replacement parts

| | | | | | | | | |
|---------|--------------|---------------------------------|--|--|--|---|--|---|
| HEW60P | 037103480064 | Heater assembly for W60P | | | | - | | 1 |
| HEW60PD | 037103593337 | Heater assembly for W60PD | | | | - | | 1 |
| SW60 | 037103474070 | Switch assembly for W60P series | | | | - | | 1 |
| KN60A | 037103474001 | Knurled tip nut for W60P series | | | | - | | 1 |



Catalog No.: **PH60**
Soldering iron stand assembly



Catalog No.: **SFA60**
Spring and funnel assembly



Catalog No.: **TC205**
Sponge

W100PG series irons

[查询"53002699"供应商](#)



- Line voltage high quality portable tool... controlled output and temperature
- Weller "closed loop" method of controlling max. tip temperature protects temperature sensitive components
- Iron features stainless steel modular plug-in heater construction for greater soldering efficiency
- Nominal heat-up time w/CT6F7 tip = 110 seconds
- Comes with CT6F7, 700°F, 1/4" dia. screwdriver tip
- Also available with 3-wire grounded cord set
- IMPORTANT: Use only Weller tips
- CT6 series tips listed on page Weller 63
- See iron fume extraction adapter kit table on page Weller 27
- UL listed

| Cat. No. | UPC No. | Description | V | W | Hz | Shelf Pack Wt. | | Shelf Pack |
|---|--------------|-----------------------------------|-----|-----|-------|----------------|------|------------|
| | | | | | | lb | kg | |
| W100PG | 037103474261 | Soldering iron w/CT6F7 tip | 120 | 100 | 50/60 | 4.75 | 2.14 | 6 |
| W100P3 | 037103474278 | Same as W100PG but w/3-wire cord | 120 | 100 | 50/60 | 4.75 | 2.14 | 6 |
| The following is available only to authorized export distributors. Units not VDE or GS approved. | | | | | | | | |
| W100PD3 | 037103593979 | Soldering iron 3-wire cord | 240 | 100 | 50/60 | 4.75 | 2.14 | 6 |
| Replacement parts | | | | | | | | |
| HEW100P | 037103480071 | Heater assembly for W100P | | | | - | | 1 |
| HEW100PD | 037103593344 | Heater assembly for W100PD | | | | - | | 1 |
| SW60 | 037103474070 | Switch assembly for W100PG series | | | | - | | 1 |
| KN100A | 037103474186 | Knurled tip nut for W100PG series | | | | - | | 1 |



Catalog No.: **PH100**
Soldering iron stand assembly



Catalog No.: **SFA100**
Spring and funnel assembly



Catalog No.: **TC205**
Sponge

Professional soldering irons WP25, WP30, WP35 series irons

Weller®

[查询"53002699"供应商](#)



- Ideal for a wide variety of electronic tasks
- Interchangeable heater elements - single handle plus three different heating elements gives the user a trio of irons for different jobs
- Quick change knurled collar makes changing heater simple
- Lightweight handle with cushioned grip
- For additional safety, all irons come with 3-wire power cord
- Irons use ST series iron plated tips for long life and greater soldering efficiency
- **IMPORTANT:** Use only Weller tips
- ST series tips listed on page Weller 63
- See iron fume extraction adapter kit table on page Weller 27
- UL listed

| Cat. No. | UPC No. | Description | V | W | Hz | Shelf Pack Wt. | | Shelf Pack |
|---|--------------|--------------------------|-----|----|-------|----------------|------|------------|
| | | | | | | lb | kg | |
| WP25 | 037103593597 | Soldering iron w/ST3 tip | 120 | 25 | 50/60 | 2.50 | 1.13 | 6 |
| WP30 | 037103593603 | Soldering iron w/ST3 tip | 120 | 30 | 50/60 | 2.50 | 1.13 | 6 |
| WP35 | 037103593610 | Soldering iron w/ST3 tip | 120 | 35 | 50/60 | 2.50 | 1.13 | 6 |
| Replacement parts | | | | | | | | |
| HE25 | 037103593627 | 25w replacement heater | | | | - | | 1 |
| HE30 | 037103593634 | 30w replacement heater | | | | - | | 1 |
| HE35 | 037103593641 | 35w replacement heater | | | | - | | 1 |
| The following is available only to authorized export distributors. Units not VDE or GS approved. | | | | | | | | |
| WP25D | 037103000309 | Soldering iron | 220 | 25 | 50/60 | 2.50 | 1.13 | 6 |
| WP30D | 037103024640 | Soldering iron | 220 | 30 | 50/60 | 2.50 | 1.13 | 6 |
| WP35D | 037103003584 | Soldering iron | 220 | 35 | 50/60 | 2.50 | 1.13 | 6 |
| HE25D | 037103001337 | 25w replacement heater | | | | - | | 1 |
| HE30D | 037103024664 | 30w replacement heater | | | | - | | 1 |
| HE35D | 037103024633 | 35w replacement heater | | | | - | | 1 |



Catalog No.: **HE25/HE30/HE35**
Replacement heater



Catalog No.: **PH60**
Iron stand assembly



Catalog No.: **SFA60**
Spring and funnel assembly



Catalog No.: **TC205**
Sponge

Weller Pro Plus™ Series soldering irons WP40S, WP60S, WP100S, WP60H

[查询"53002699"供应商](#)



WP60S



WP60H

- Plug-in heating element changes quickly and easily reducing downtime and increasing productivity
- Wide selection of tips in different sizes and styles
- Easy-to-replace, long-lasting iron-plated tips
- Comfortable cushioned-grip handle stays cool
- 3-wire grounded plug
- All tips ordered separately. See page Weller 64
- UL listed

| Cat. No. | UPC No. | Description | V | W | Hz | Shelf Pack Wt. | | Shelf Pack |
|--|--------------|--|-----|-----|-------|----------------|------|------------|
| | | | | | | lb | kg | |
| Pro Plus™ Series Soldering Irons | | | | | | | | |
| WP40S | 037103110718 | 40-watt iron without tip - Straight | 120 | 40 | 50/60 | 2.80 | 1.27 | 6 |
| WP60S | 037103110879 | 60-watt iron without tip - Straight | 120 | 60 | 50/60 | 2.80 | 1.27 | 6 |
| WP60H | 037103110749 | 60-watt iron without tip - Hatchet | 120 | 60 | 50/60 | 2.80 | 1.27 | 6 |
| WP100S | 037103110855 | 100-watt iron without tip - Straight | 120 | 100 | 50/60 | 2.80 | 1.27 | 6 |
| Pro Plus™ Series Heating Elements | | | | | | | | |
| WP40SMOD | 037103110916 | Straight 40-watt Plug-in Heater w/o tip | - | 40 | - | 1.22 | .55 | 6 |
| WP60SMOD | 037103110930 | Straight 60-watt Plug-in Heater w/o tip | - | 60 | - | 1.22 | .55 | 6 |
| WP60HMOD | 037103110770 | Hatchet 60-watt Plug-in Heater w/o tip | - | 60 | - | 1.22 | .55 | 6 |
| WP100SMOD | 037103110787 | Straight 100-watt Plug-in Heater w/o tip | - | 100 | - | 1.22 | .55 | 6 |

WM120 pencil thin soldering iron

[查询"53002699"供应商](#)



- Lightweight, pencil thin soldering iron with stay-cool handle
- Designed for soldering miniature components
- Develops tip temperature of 800°F (427°C)
- 3 wire grounded plug
- Uses Weller MP series auto slide-in tips
- IMPORTANT: Use only Weller tips
- MP series tips listed on page Weller 65
- UL listed

| Cat. No. | UPC No. | Description | V | W | Hz | Shelf Pack Wt. | | Shelf Pack |
|----------|--------------|--------------------------|-----|----|-------|----------------|------|------------|
| | | | | | | lb | kg | |
| WM120 | 037103477118 | Miniature soldering iron | 120 | 12 | 50/60 | 3.00 | 1.35 | 6 |



Catalog No.: **PH1301ESD**
Iron stand assembly



Catalog No.: **IHF225EC**
Spring and funnel assembly



Catalog No.: **TC205**
Sponge

Temtronic soldering pencil Peritronic MPR30



- Operation of soldering tip adjusts continuously up to 40° of angle by loosening lock screw
- Unobstructed view of work area meets individual needs of each operator
- Screw knurl fastens tip and barrel
- Temperature sensor placed in center of tip
- Heater located inside tip for high efficiency
- 5-wire silicone cord
- Use with any "EC" station
- MPT series tips listed on page Weller 65

| Cat. No. | UPC No. | Description | V | W | Hz | Shelf Pack Wt. | | Shelf Pack |
|----------|--------------|-------------------------------------|----|----|----|----------------|------|------------|
| | | | | | | lb | kg | |
| MPR30 | 037103043696 | Temtronic soldering pencil w/stand | 24 | 30 | 60 | 2.50 | 1.13 | 1 |
| KH25P | 037103049179 | Iron stand assembly (packed w/iron) | - | - | - | - | - | 1 |



Catalog No.: **KH25P**
Iron stand assembly

Marksman® soldering irons SP12 Mini iron (12 watt)

[查询"53002699"供应商](#)



- Fine quality mini iron
- Produces 12 watts
- 7 in./178 mm long
- Lightweight and pencil thin
- Ideal for fine soldering and hobby work such as electronic kits, model railways and jewelry making
- Replaceable nickel-plated copper tip see page Weller 68
- Stainless steel barrel
- Heat and impact resistant handle
- UL Listed

| Cat No. | UPC No. | Description | V | W | Hz | Pack Wt. | | Shelf Pack |
|---------|--------------|----------------|-----|----|-------|----------|------|------------|
| | | | | | | lb | kg | |
| SP12 | 037103479716 | Soldering iron | 120 | 12 | 50/60 | 3 | 1.36 | 6 |

SP23 Iron (25 watt)



- Fine quality iron
- Produces 25 watts
- 8-1/4 in./210 mm long
- Featherweight iron with pencil handle
- Ideal for hobbies, kits and radios
- MT1 1/8 in./3 mm diameter replaceable nickel-plated copper tip see page Weller 68
- Develops 750°F/400°C
- Stainless steel barrel
- Heat and impact resistant handle
- UL Listed

| Cat No. | UPC No. | Description | V | W | Hz | Pack Wt. | | Shelf Pack |
|---------|--------------|----------------|-----|----|-------|-------------------------------|-----|------------|
| | | | | | | lb | kg | |
| SP23 | 037103473684 | Soldering iron | 120 | 25 | 50/60 | 5 ¹ / ₈ | 2.5 | 6 |

The following is available only to authorized export distributors. Units not VDE or GS Approved.

| | | | | | | | | |
|-------|--------------|----------------|---------|----|-------|-------------------------------|-----|----|
| SP25D | 037103475909 | Soldering iron | 220/240 | 25 | 50/60 | 5 ¹ / ₈ | 2.5 | 12 |
|-------|--------------|----------------|---------|----|-------|-------------------------------|-----|----|

SP40 iron (40 watt)



- Fine quality iron
- Produces 40 watts
- 8-1/4 in./210 mm long
- Lightweight pencil iron
- Ideal for hobby and electronic work
- MT10 1/4 in./10 mm diameter replaceable nickel-plated copper tip see page Weller 68
- Develops 900°F/482°C
- Stainless steel barrel
- Heat and impact resistant handle
- UL Listed

| Cat No. | UPC No. | Description | V | W | Hz | Pack Wt. | | Shelf Pack |
|---------|--------------|----------------|-----|----|-------|-------------------------------|-----|------------|
| | | | | | | lb | kg | |
| SP40 | 037103473875 | Soldering iron | 120 | 40 | 50/60 | 2 ¹ / ₄ | 1.2 | 6 |

The following is available only to authorized export distributors. Units not VDE or GS Approved.

| | | | | | | | | |
|-------|--------------|----------------|---------|----|-------|---|----|---|
| SP40D | 037103475923 | Soldering iron | 220/240 | 40 | 50/60 | 2 | .9 | 6 |
|-------|--------------|----------------|---------|----|-------|---|----|---|

SP80 Iron (80 watt)

- Fine quality, medium-duty iron produces 80 watts
- Ideal for hobby work, stained glass and minor repairs
- Soldering iron rest included
- MT20 3/8 in./10 mm diameter replaceable nickel-plated copper tip see page Weller 68
- Develops 900°F/482°C
- Stainless steel barrel
- Heat and impact resistant handle
- UL Listed



| Cat No. | UPC No. | Description | V | W | Hz | Pack Wt. | | Shelf Pack |
|---|--------------|----------------|---------|----|-------|-------------------------------|------|------------|
| | | | | | | lb | kg | |
| SP80 | 037103474131 | Soldering iron | 120 | 80 | 50/60 | 3 | 1.36 | 6 |
| The following is available only to authorized export distributors. Units not VDE or GS approved. | | | | | | | | |
| SP80D | 037103475930 | Soldering iron | 220/240 | 80 | 50/60 | 2 ³ / ₄ | 1.25 | 6 |

SP120 Iron (120 Watt)

- Fine quality iron
- Produces 120 watts
- 11-3/8 in./289 mm long
- Ideal for home workshop, repairs, stained glass and hobbies
- Soldering iron rest included
- MTG30 1/2 in./13 mm diameter replaceable iron-plated copper tip
- Develops 900°F/482°C
- Stainless steel barrel
- Heat and impact resistant handle
- IMPORTANT: Use only Weller® tips. Use of non-Weller components may void product warranty if the non-Weller component causes damage to the unit.
- MTG series tips listed on page Weller 68
- UL listed



| Cat. No. | UPC No. | Description | V | W | Hz | Shelf Pack Wt. | | Shelf Pack |
|---|--------------|----------------|-----|-----|-------|----------------|------|------------|
| | | | | | | lb | kg | |
| SP120 | 037103474537 | Soldering iron | 120 | 120 | 50/60 | 3.50 | 1.58 | 3 |
| The following is available only to authorized export distributors. Units not VDE or GS approved. | | | | | | | | |
| SP120D | 037103590305 | Soldering iron | 240 | 120 | 50/60 | 3.50 | 1.58 | 3 |

SP175 Iron (175 Watt)

- Fine quality iron
- Produces 175 watts
- 12-1/2 in./318 mm long
- Extra heavy-duty for demanding jobs like sheet metal work
- Soldering iron rest included
- MTG40 5/8 in./16 mm diameter replaceable iron-plated copper tip
- Develops 900°F/482°C
- Stainless steel barrel
- Heat and impact resistant handle
- IMPORTANT: Use only Weller® tips. Use of non-Weller components may void product warranty if the non-Weller component causes damage to the unit
- MTG series tips listed on page Weller 68
- UL listed



| Cat. No. | UPC No. | Description | V | W | Hz | Shelf Pack Wt. | | Shelf Pack |
|---|--------------|----------------|-----|-----|-------|----------------|------|------------|
| | | | | | | lb | kg | |
| SP175 | 037103474674 | Soldering iron | 120 | 175 | 50/60 | 4.00 | 1.80 | 3 |
| The following is available only to authorized export distributors. Units not VDE or GS approved. | | | | | | | | |
| SP175D | 037103590299 | Soldering iron | 240 | 175 | 50/60 | 4.00 | 1.80 | 3 |

Cordless soldering tools WSTA3 Pyropen®

[查询"53002699"供应商](#)



- Lightweight and completely portable
- Ready to use in 30 seconds
- Ideal for field service jobs
- Sturdy metal tank holds enough gas for three hours of operation
- Does not require cords, batteries or cartridges
- Temperature adjusts from 392°F-932°F/200°C-500°C
- 14 tip combinations available
- Inactive hot air nozzles for low temperature heat are available
- Refills with butane lighter gas - Weller cat. no. WB1
- WPT series tips listed on page Weller 69

| Cat. No. | UPC No. | Description | Shelf Pack Wt. | | Shelf Pack |
|----------|--------------|-------------------------|----------------|-----|------------|
| | | | lb | kg | |
| WSTA3 | 037103472281 | Cordless soldering iron | 1 | .45 | 3 |

Replacement parts: See replacement parts book

WPA2 Self Igniting Pyropen®



- Ignites with the push of a button
- Lightweight and completely portable
- Ready to use in 30 seconds
- Ideal for field service jobs
- Sturdy metal tank holds enough gas for three hours of operation
- Does not require cords, batteries or cartridges
- Temperature adjusts from 482°F-932°F/250°C-500°C
- 14 soldering tip combinations available
- Inactive hot air nozzles for low temperature heat (1202°F/650°C) are available
- Refills with butane lighter gas - Weller cat. no. WB1
- All temperatures are approximate
- WPT series tips listed on page Weller 69

| Cat. No. | UPC No. | Description | Shelf Pack Wt. | | Shelf Pack |
|----------|--------------|---------------------------------------|----------------|------|------------|
| | | | lb | kg | |
| WPA2 | 037103590435 | Self-igniting cordless soldering iron | 0.50 | 0.22 | 1 |
| WPAPC | 037103590442 | Pyropen plastic cap | 0.13 | 0.06 | 1 |
| WPAE | 037103590459 | Pyropen ejector | 0.06 | 0.02 | 1 |
| WPAB | 037103590466 | Pyropen burner | 0.07 | 0.03 | 1 |
| WPACN | 037103590480 | Pyropen cap nut | 0.05 | 0.02 | 1 |

WST2 Pyropen® Jr

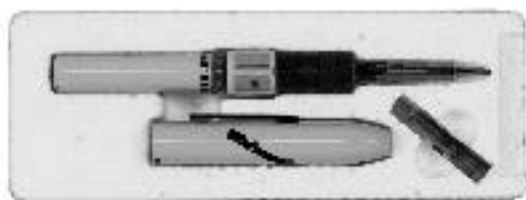

- Lightweight mini iron
- Does not require cords, batteries or cartridges
- Dual function soldering iron and brazing torch
- Temperature control
- Soldering iron: 392°F-842°F/200°C-450°C; hotblow feature: 806°F /430°C maximum; torch feature: 2372°F /1300°C maximum
- Long life soldering tips heat quickly
- Refills with butane lighter gas - Weller cat. no. WB1
- All temperatures are approximate
- WPT series tips listed on page Weller 70

| Cat. No. | UPC No. | Description | Shelf Pack Wt. | | Shelf Pack |
|----------|--------------|-------------------------|----------------|------|------------|
| | | | lb | kg | |
| WST2 | 037103477514 | Cordless soldering iron | 0.50 | 0.22 | 1 |

Replacement parts: See replacement parts book

PSI100 Portasol®

- Self-igniting portable butane heat tool

[查询"53003698"供应商](#)
Allows anti-static soldering

- Features "Auto Switch" safety shut-off, iron plated tips, and built-in filter
- Rugged stainless-steel body provides up to 125 watts of power
- Adjustable temperature up to 1,076°F
- Fuel level is clearly visible through a window on the body of the tool
- Refills with butane lighter gas – Weller cat no. WB1
- PS series tips listed on page Weller 70



| Cat. No. | UPC No. | Packed | Description | Pack Wt. | | Shelf Pack |
|----------|--------------|--------|--|----------|-----|------------|
| | | | | lb | kg | |
| PSI100 | 037103060969 | Boxed | Portasol Cordless, refillable butane gas-powered soldering tool. | .3 | .14 | 1 |
| PSI100C | 037103127174 | Carded | Portasol Cordless, refillable butane gas-powered soldering tool. | .3 | .14 | 1 |

Portasol® is a registered trademark of Oglesby and Butler Limited.

PSI100K Portasol® Kit

- Professional quality Portasol® heat tool
- Ideal for service technicians to solder, heat shrink and cut rope
- Butane fuel level is visible through a window on the body of the tool
- Built-in fuel filter reduces contaminated fuel problems
- Auto switch safety shut off on cap
- Operates up to 2 hours per refill
- Temperature is fully adjustable
- Maximum temperature of 1076°F/580°C
- Kit contains PSI100 iron, sponge, stand and extra tips packed in a plastic case
- PS series tips listed on page Weller 70



| Cat. No. | UPC No. | Packed | Description | Shelf Pack Wt. | | Shelf Pack |
|----------|--------------|--------|--|----------------|------|------------|
| | | | | lb | kg | |
| PSI100K | 037103060976 | Boxed | Portasol Cordless, refillable butane gas-powered soldering tool kit. | 1.30 | 0.59 | 1 |

Portasol® is a registered trademark of Oglesby and Butler Limited.

P1 Portasol®

- Does not require cords, batteries or cartridges
- Patented soldering tool has a catalytic converter that provides a powerful yet safe flameless combustion
- Refills with butane lighter gas – Weller cat. no. WB1
- Tank holds gas for 90 minute operation
- Safety cut-off switch when cap replaced
- Flint-spark ignitor in cap
- Ideal for a wide variety of soldering and desoldering jobs at work or at home
- Adjustable temperature control regulates the power (the equivalent of 10-60 watts) to quickly heat the tip
- Develops 850°F/454°C
- Optional accessories convert the P-1 into a soldering iron, blow torch, hot blower and hot knife
- T series tips listed on page Weller 71



| Cat. No. | UPC No. | Description | Shelf Pack Wt. | | Shelf Pack |
|----------|--------------|---|----------------|----|------------|
| | | | lb | kg | |
| P1B | 037103593351 | Portasol® Cordless-refillable Butane gas powered soldering tool. Boxed | - | - | 6 |
| P1C | 037103593368 | Portasol® Cordless-refillable Butane gas powered soldering tool. Carded | - | - | 6 |

Portasol® is a registered trademark of Oglesby and Butler Limited.

P1 Portasol® Kit

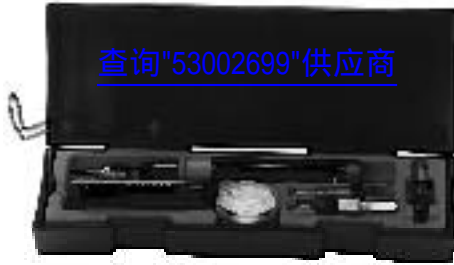

- Does not require cords, batteries or cartridges
- Patented soldering tool has a catalytic converter that provides a powerful yet safe flameless combustion
- Refills with butane lighter gas - Weller cat. no. WB1 (not included)
- Ideal for a wide variety of soldering jobs at work or at home
- Develops 850°F/450°C
- Kit contains Portasol® P1 soldering tool, 3/32 in./2.4 mm iron-plated soldering tip, hot knife accessory, hot blower accessory, blow torch accessory, cleaning sponge and safety stand
- Packed in a rugged plastic case
- T series tips listed on page Weller 71

| Cat. No. | UPC No. | Description | Shelf Pack Wt. | | Shelf Pack |
|----------|--------------|--|----------------|------|------------|
| | | | lb | kg | |
| P1KB | 037103593375 | Portasol® Cordless-refillable Butane gas powered soldering tool kit. Boxed | 2.5 | 1.13 | 4 |
| P1KC | 037103593382 | Portasol® Cordless-refillable Butane gas powered soldering tool. Carded | 2.6 | 1.18 | 4 |

Portasol® is a registered trademark of Olglesby and Butler Limited.

C1C Portasol®



- Does not require cords, batteries or cartridges
- Patented soldering tool has a catalytic converter that provides a powerful yet safe flameless combustion
- Refills with butane lighter gas – Weller cat. no. WB1 (not included)
- Safety cut-off switch when cap replaced
- Sturdy plastic cap fits neatly on back of tool during use
- C2 soldering tip included see page Weller 71
- 3 easily interchangeable screw-in tips are available
- Lightweight black case fits comfortably in hand
- Kit contains C1C iron, sponge, stand and extra tips packed in a plastic case

| Cat No. | UPC No. | Description | Pack Wt. | | Shelf Pack |
|---------|--------------|--|----------|-----|------------|
| | | | lb | kg | |
| C1C | 037103593696 | Portasol Cordless refillable Butane gas powered soldering tool, carded | 1.14 | .52 | 6 |
| C1KC | 037103127402 | Portasol Cordless Refillable Butane gas powered soldering tool kit, carded | 1.95 | .89 | 6 |

Portasol® is a registered trademark of Olglesby and Butler Limited.

Premium butane fuel for Portasol® and Pyropen® irons



- Premium quality butane fuel
- Compatible with Weller® Portasol® and Weller® Pyropen® tools
- Weighs 2.1 oz/60 g
- Printed in English and Spanish with operating instructions on back of can

| Cat No. | UPC No. | Packed | Description | Net Wt. | | Pack Wt. | | Shelf Pack |
|---------|--------------|--------|---------------------|---------|----|----------|------|------------|
| | | | | oz | g | lb | kg | |
| WB1 | 037103060921 | Boxed | Premium butane fuel | 2.1 | 60 | 2.9 | 1.32 | 12 |
| WB2 | 037103126917 | Boxed | Premium butane fuel | 1.0 | 28 | 1.4 | 0.60 | 12 |

Portasol® is a registered trademark of Olglesby and Butler Limited.



[查询"53002699"供应商](#)

WFE2P

Weller®

- Efficient 4-stage, replaceable filter system removes 99.995% of contaminants up to 3 microns
- No external air source required
- Silent-running, maintenance-free rotary pump
- Compact size makes it convenient to use anywhere
- For use with FE Series soldering irons
- Fully portable



| Cat No. | UPC No. | Description | Shelf Pack Wt. | | Shelf Pack |
|---------|--------------|--|----------------|-----|------------|
| | | | lb | kg | |
| WFE2P | 037103126764 | Self contained 2 person fume extractor, 120v | 6.6 | 3.0 | 1 |



WFE20

- Efficient 4-stage, replaceable filter system removes 99.997% of contaminants up to 3 microns
- Silent-running, maintenance-free turbine
- Vacuum turbine protected with thermal and electrical fuse
- Accommodates up to 20 Weller fume extraction soldering irons, 5 directly to the unit (or up to 2 arm extractors)
- Washable filters for longer life
- Wheeled design for portability



| Cat No. | UPC No. | Description | Shelf Pack Wt. | | Shelf Pack |
|---------|--------------|--------------------------|----------------|----|------------|
| | | | lb | kg | |
| WFE20 | 037103127136 | 20 person fume extractor | 121 | 55 | 1 |

Airex fume extraction system

[查询"53002698"供应商](#)



- 3-stage filter insures 99.97% filtration of particles
- Small space requirement allows convenient placement without disturbing surrounding work areas
- Connects to soldering irons with integral fume extraction or converted soldering irons with Clip-On Extractor Kit
- Easy to install, connects to compressed air supply (50-130PSI)
- Long service life
- Supports connection to exhaust air piping system
- Good value
- Low operating costs
- Quiet operation will not disturb surrounding work areas
- Includes 5'-0" extractor hose and 3'-0" compressed air hose
- Supports connection to soldering irons with twin-hose for cooling handle
- See iron fume extraction adapter kit table on page Weller 27

| Cat. No. | UPC No. | Description | Working Pressure | Shelf Pack Wt. | | Shelf Pack |
|--------------------------|--------------|--|------------------|----------------|-------|------------|
| | | | | lb | kg | |
| WAX1 | 037103088161 | Airex Fume extraction system | 50 to 125 PSI | 5.5 | 2.5 | 1 |
| WAXK2 | 037103088505 | Kit for connecting two soldering irons | - | 0.10 | 0.05 | 1 |
| Replacement parts | | | | | | |
| WAXH1 | 037103088512 | Replacement extractor hose - 5' long | - | 0.10 | 0.05 | 1 |
| WAXF1 | 037103088178 | Replacement filter | - | 5.0 | 2.23 | 1 |
| WAXSF1 | 037103088536 | Replacement silencer filter | - | 0.010 | 0.004 | 1 |

Soldering Stations with fume extraction irons EC10021FE, EC2002M1FE, WTCPTFE

[查询"53002699"供应商](#)

- Three high quality precision soldering stations, each equipped with fume extraction iron
- ESD, impact resistant case protects sensitive components
- Adjustable 3/16" dia. stainless steel exhaust tube on iron for precise positioning over work
- 3/16" dia. x 7' length ESD safe tubing attaches to stainless steel exhaust tube and connects to fume extraction system
- Power Units: 120V; 60W; 60Hz
- See iron fume extraction adapter kit table on page Weller 27



| Cat. No. | UPC No. | Description | Iron | | | Shelf Pack Wt. | | Shelf Pack |
|------------|--------------|--|------|----|----|----------------|------|------------|
| | | | V | W | Hz | lb | kg | |
| EC10021FE | 037103044556 | EC1002-0 Power unit w/EC1201AFE Iron, ETA tip | 24 | 42 | 60 | 4.00 | 1.80 | 1 |
| EC2002M1FE | 037103105837 | EC2002M-0 power unit w/EC1201AFE iron, ETA tip | 24 | 42 | 60 | 4.00 | 1.80 | 1 |
| WTCPTFE | 037103044549 | PU120T Power unit w/TC201FE Iron, PTA7 tip | 24 | 42 | 60 | 4.00 | 1.80 | 1 |



Catalog No.: **EC10021FE**
EC1201AFE 42w iron w/ETA tip and stand.



Catalog No.: **WTCPTFE**
TC201FE 42w iron w/PTA7 tip and stand.



Catalog No.: **PH1201FE**
Iron stand assembly.



Catalog No.: **TC205**
Sponge.

Irons for fume extraction systems

TC201FE

[查询"53002699"供应商](#)



- Designed for use with Weller® or Airex® system
- Highly efficient and comfortable to use
- Adjustable 3/16" dia. stainless steel exhaust tube on iron for precise positioning over work
- 3/16" dia. x 7' length ESD safe tubing attaches to stainless steel exhaust tube
- Use with Weller® WTCP series stations and any Weller® Fume Extraction System
- PT series tips listed on page Weller 62
- See iron fume extraction adapter kit table on page Weller 27

| Cat. No. | UPC No. | Description | V | W | Hz | Shelf Pack Wt. | | Shelf Pack |
|----------|--------------|-------------------------------|----|----|----|----------------|------|------------|
| | | | | | | lb | kg | |
| TC201FE | 037103592255 | Soldering iron w/PTA7 tip | 24 | 42 | 60 | 0.37 | 0.16 | 1 |
| EC234FE | 037103592279 | Heater assembly for TC201FE | 24 | 42 | - | 0.05 | 0.02 | 1 |
| RTFE | 037103592309 | Replacement tubing - 7' clear | - | - | - | 0.25 | 11.3 | 1 |



Catalog No.: **PH1201FE**
Iron stand assembly



Catalog No.: **RSFFE**
Spring and funnel assembly



Catalog No.: **TC205**
Sponge

EC1201AFE



- Designed for use with Weller® or Airex® Fume Extraction Systems
- Highly efficient and comfortable to use
- Adjustable 3/16" dia. stainless steel exhaust tube on iron for precise positioning over work
- 3/16" dia. x 7' length of ESD safe tubing connects to stainless steel exhaust tube
- Use with Weller EC1002-0, EC2002-0, MC5001-0, WTL1000-0, DEC1001 or DTL1000 power units
- ET series tips listed on page Weller 57
- See iron fume extraction adapter kit table on page Weller 27

| Cat. No. | UPC No. | Description | V | W | Hz | Shelf Pack Wt. | | Shelf Pack |
|-----------|--------------|-------------------------------|----|----|----|----------------|------|------------|
| | | | | | | lb | kg | |
| EC1201AFE | 037103001948 | Soldering iron w/ETA tip | 24 | 42 | 60 | 0.37 | 0.16 | 1 |
| EC234FE | 037103592279 | Heater assembly for EC1201AFE | 24 | 42 | - | 0.05 | 0.02 | 1 |
| EC268 | 037103042231 | Sensor assembly for EC1201AFE | - | - | - | 0.05 | 0.02 | 1 |
| WF1026 | 037103593542 | Replacement tubing - 7' ESD | - | - | - | 0.25 | 0.11 | 1 |



Catalog No.: **PH1201FE**
Iron stand assembly



Catalog No.: **RSFFE**
Spring and funnel assembly



Catalog No.: **TC205**
Sponge

WELLER® ADAPTER TABLE
ADAPTER CATALOG NUMBER

[查询"53002699"供应商](#)

| Manufacturer | Iron Model No. | [StationNo.] | AKFE1-1 | AKFE2 | AKFE3 | AKFE4 | AKFE5 | AKFE6 | ECMFE | MSFE | |
|----------------|----------------|--------------|---------|-------|-------|-------|-------|-------|-------|------|---|
| Weller® | EC1201A | | • | | | | | | | | |
| | EC1201R | | • | | | | | | | | |
| | EC1302A | | | | | | | | • | | |
| | EC1302R | | | | | | | | • | | |
| | EC1503A | | | | | | | | • | | |
| | EC1503R | | | | | | | | • | | |
| | | MT1500(L) | | | | | | | | | • |
| | | SP23 | | • | | | | | | | |
| | | SP40 | | • | | | | | | | |
| | | SP80 | | • | | | | | | | |
| | | SPG80 | | • | | | | | | | |
| | | TC201T | | • | | | | | | | |
| | | TC201P | | • | | | | | | | |
| | | W100P | | • | | | | | | | |
| | | W100PG | | • | | | | | | | |
| | | W60P | | • | | | | | | | |
| | | WP25 | | | | • | | | | | |
| | | WP30 | | | | • | | | | | |
| | | WP35 | | | | • | | | | | |
| | | WP25P | | • | | | | | | | |
| | | WP40P | | • | | | | | | | |
| | | WTL120 | | • | | | | | | | |
| | | | WCC100 | • | | | | | | | |
| | | WLC100 | • | | | | | | | | |
| | | WLC200 | • | | | | | | | | |
| Ungar® | 5550 | | | | | • | | | | | |
| | 555XR | | | | | • | | | | | |
| | 555XT | | | | | • | | | | | |
| | 7400 | | | | | • | | | | | |
| | 7500 | | | | | • | | | | | |
| | 9300 | | | | | | | • | | | |
| | 9910AS | | | | | | | • | | | |
| | 9910HC | | | | | | | • | | | |
| | 9911AS | | | | | | | • | | | |
| | 9931AS | | | • | | | | | | | |
| | 9941AS | | | | | | | • | | | |
| | SL325 | | | | | • | | | | | |
| | SL335 | | | | | • | | | | | |
| | SL345 | | | | | • | | | | | |
| SL500 | | | | | • | | | | | | |

WELLER® ADAPTER TABLE ADAPTER CATALOG NUMBER

[查询"53002699"供应商](#)

| Manufacturer | Iron Model No. | [Station No.] | AKFE1-1 | AKFE2 | AKFE3 | AKFE4 | AKFE5 | AKFE6 | ECMFE | MSFE |
|----------------|----------------|---------------|---------|-------|-------|-------|-------|-------|-------|------|
| Ungar® | | 2110 | | | | • | | | | |
| | | UTC100 | • | | | | | | | |
| | | UTC200 | | | | | | • | | |
| | | UTC300 | • | | | | | | | |
| Pace | IR-70 | | • | | | | | | | |
| Jensen | 47B723 | | | | • | | | | | |
| Hexacon | | 1002 | • | | | | | | | |
| | | 1002PBS | • | | | | | | | |
| | | HTC5500 | • | | | | | | | |
| | | HTC5600 | • | | | | | | | |
| Hakko | 900M | | | • | | | | | | |
| | 900L | | | • | | | | | | |
| | 900MESD | | | • | | | | | | |
| | 900LESD | | | • | | | | | | |
| Edsyn | 930 | 951 | | | | | • | | | |

DS800 Electronically controlled desoldering station



- High performance **internal rotary vane pump** delivers improved vacuum flow for quicker desoldering
- High mass head desoldering tool and tiplests aid in improved heat transference
- Ideal for multilayered boards
- Quality ESD construction... ESD safe
- Electronically controlled full range temperature selection (350°F - 850°F) assures fast response
- Convenient index finger push button controls the vacuum
- Tiplests listed on pages Weller 72 & 73
- Meets MIL SPECS:DOD-STD-2000, MIL-S-45743, Mil-STD-2000, W-S-6536, W-S-570, DOD-STD-1686, DOD-HDB-263
- UL listed

| Cat. No. | UPC No. | Description | V | W | Hz | Shelf Pack Wt. | | Shelf Pack |
|--|--------------|--|-----|-----|-------|----------------|------|------------|
| | | | | | | lb | kg | |
| DS800 | 037103593207 | Complete station-24v Output | 120 | 150 | 60 | 11.50 | 5.20 | 1 |
| DS1203A | 037103086006 | Desoldering tool | 24 | 54 | - | 0.31 | 0.14 | 1 |
| The following is available only to authorized export distributors. Unit not VDE or GS approved. | | | | | | | | |
| DS800D | 037103042217 | Complete station-24v Output | 220 | 150 | 50/60 | 11.50 | 5.20 | 1 |
| Replacement parts | | | | | | | | |
| DS219 | 037103104045 | Desoldering head High Mass/threaded tiplests | | | | - | - | 1 |
| DSH54 | 037103593191 | Heater assembly for DS1203A | | | | - | - | 1 |
| DS205 | 037103476531 | In-line filter | | | | - | - | 10 |



Catalog No.: **DS2010**
Desoldering iron stand assembly

DS700M Electronically controlled desoldering station

- Product designed as technicians Portable unit (Intermittent use)
- Lightweight, compact electronic desoldering unit with internal vacuum pump
- Fingertip control of desoldering vacuum
- Special, large capacity air filter provided in power unit to back up small filter in tool's solder-collection reservoir
- Air output for low volume heat shrinking and other hot air jobs
- Lightweight desoldering tool with convenient index finger push button to control vacuum
- ESD safe
- SPEC. COMPLIANCE DOD-STD-2000-1, Mil-STD-2000
- Tiptets listed on page Weller 73
- UL listed



| Cat. No. | UPC No. | Description | V | W | Hz | Shelf Pack Wt. | | Shelf Pack |
|----------|--------------|-----------------------------|-----|----|----|----------------|------|------------|
| | | | | | | lb | kg | |
| DS700M | 037103480583 | Complete station-24v Output | 120 | 60 | 60 | 6.00 | 2.71 | 1 |
| DS1201 | 037103480286 | Desoldering tool | 24 | 42 | - | 0.31 | 0.14 | 1 |

The following is available only to authorized export distributors. Unit not VDE or GS approved.

| | | | | | | | | |
|---------|--------------|------------------|-----|----|-------|------|------|---|
| DS700MD | 037103593931 | Complete station | 240 | 60 | 50/60 | 6.00 | 2.71 | 1 |
|---------|--------------|------------------|-----|----|-------|------|------|---|

Replacement parts

| | | | | | | | | |
|-------|--------------|--------------------------------------|---|---|---|---|---|----|
| DS229 | 037103104045 | Desoldering head for tapered tiptets | - | - | - | - | - | 1 |
| EC234 | 037103479747 | Heater assembly for DS1201 | - | - | - | - | - | 1 |
| DS205 | 037103476531 | In-line filter | - | - | - | - | - | 10 |



Catalog No.: **DS1201**
Desoldering iron

DS600 Portable desoldering station

- **Self-contained vacuum system** requires 120 volt 60 Hz A.C. power source for operation
- Conveniently placed push button allows right or left handed operation
- Desoldering head temperature controlled to 700°F (371°C) included
- Carrying handle
- Power cord storage
- Built-in iron holder
- Tiptets listed on page Weller 72
- UL listed



| Cat. No. | UPC No. | Description | V | W | Hz | Shelf Pack Wt. | | Shelf Pack |
|----------|--------------|-----------------------------|-----|-----|----|----------------|------|------------|
| | | | | | | lb | kg | |
| DS600 | 037103478207 | Complete station-24v Output | 120 | 110 | 60 | 11.00 | 4.97 | 1 |
| DS601P | 037103478689 | Desoldering tool | 24 | 42 | - | 0.25 | 0.11 | 1 |

The following is available only to authorized export distributors. Unit not VDE or GS approved.

| | | | | | | | | |
|--------|--------------|-----------------------------|-----|-----|-------|-------|------|---|
| DS600D | 037103005250 | Complete station-24v Output | 220 | 110 | 50/60 | 11.00 | 4.97 | 1 |
|--------|--------------|-----------------------------|-----|-----|-------|-------|------|---|

Replacement parts

| | | | | | | | | |
|-------|--------------|--|---|---|---|---|---|----|
| DS228 | 037103104069 | Desoldering head for tapered tiptets (800°F) | - | - | - | - | - | 1 |
| EC234 | 037103479747 | Heater assembly for DS601P | - | - | - | - | - | 1 |
| SW60 | 037103474070 | Switch assembly for DS601P | - | - | - | - | - | 1 |
| DS205 | 037103476531 | In-line filter | - | - | - | - | - | 10 |



Catalog No.: **DS601P**
Desoldering iron

DS200 Electronically controlled desoldering/soldering station

[查询"53002699" 供应商](#)



DS200



DS200K

- Electronically controlled, dual input soldering/ desoldering station ideal for limited space work areas
- Uses fast-responding **shop-air**, controlled with pneumatic foot-switch
- High-wattage for quicker thermal recovery
- Meets Mil SPEC. COMPLIANCE — DOD-STD-2000, Mil-S-2000, Mil-S-45743, W-S-6536, W-S-570 and DOD-STD-1686
- Low-cost, high-performance and flexibility to use any of the latest Weller irons (EC1201A, EC1302A, EC1503A)
- ET series tips listed on page Weller 57
- Tiplets listed on page Weller 72 & 73
- UL listed

| Cat. No. | UPC No. | Description | V | W | Hz | Shelf Pack Wt. | | Shelf Pack |
|--|--------------|--|-----|-----|-------|----------------|-----|------------|
| | | | | | | lb | kg | |
| DS200 | 037103024671 | Soldering/Desoldering station w/EC1201A Soldering iron and DS1204A Desoldering Tool, Foot switch & stand | 120 | 130 | 60 | 10.00 | 4.5 | 1 |
| DS200K | 037103024695 | Desoldering kit w/DS1204A Desoldering, Tool, Foot switch & stand | 24 | 54 | - | 5.00 | 2.3 | 1 |
| The following is available only to authorized export distributors. Unit not VDE or GS approved. | | | | | | | | |
| DS200D | 037103045911 | Soldering/Desoldering station w/EC1201A Soldering iron and DS1204A Desoldering Tool, Foot switch & stand | 240 | 130 | 50/60 | 10.00 | 4.5 | 1 |

Weller® Temperature controlled rework stations WRS3000 rework station

Weller®

Self-contained, ESD safe station designed to handle all rework and repair of mixed technology boards

- Built-in microprocessor provides simultaneous controlled desoldering, soldering and hot air functions with complete accuracy and reliability
- Programmable temperature, hot air time and automatic temperature set-back
- Operator lock-out feature prevents any unauthorized changes
- Input watts: 300W; Timer set: 1-60 seconds
- Temperature range: Hot air 300°F - 980°F; Solder/Desolder 300°F - 850°F
- Temperature set-back: 5-60 minutes in 5 minute increments
- Compatible with Weller and Ungar soldering and desoldering irons



ESD SAFE



| Cat. No. | UPC No. | Description | Power Unit | | | Shelf Pack Wt. | | Shelf Pack |
|----------|--------------|---------------------------|------------|-----|----|----------------|-----|------------|
| | | | V | W | Hz | lb | kg | |
| WRS3000 | 037103088642 | Rework station-Output 24v | 120 | 300 | 60 | 12.2 | 5.5 | 1 |

Optional accessories:



Catalog No.: **EC1201AP**
40W Soldering iron and stand
ETA tip



Catalog No.: **EC1302AP**
20W Soldering iron and stand
EPH101 tip



Catalog No.: **EC1503AP**
42W Soldering iron and stand
EMAtip



Catalog No.: **DS1203AP**
54W Desoldering tool and stand
DSH112 tiptet



Catalog No.: **DS59**
Desoldering pistol and stand
4006 tiptet

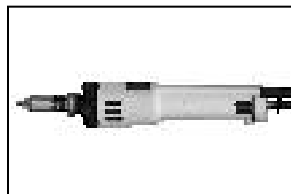

Catalog No.: **DS58**
Desoldering pencil and stand
- 4006 tiptet



Catalog No.: **WST20**
Thermal stripper



Catalog No.: **HAP1**
Hot air pencil and stand



Catalog No.: **9911AS**
Micro-size iron - 24v,
9012 tip

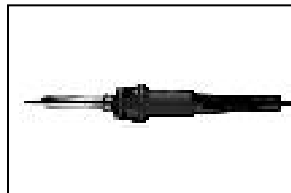

Catalog No.: **9931AS**
Macro-size iron - 24v,
9960 tip



Catalog No.: **WHPS**
Preheat plate



Catalog No.: **WSS1**
Stand system w/stands.
Order iron holder and stands
separately



Catalog No.: **FS1**
Foot pedal



Catalog No.: **ADP1**
Adapter for 9911AS, 9911HC,
9931AS, 5088AS, 5098AS

WRS2000 hot gas rework station



[查询"53002699"供应商](#)



- Electronically controlled, ESD-safe hot gas rework station
- Multiple SMD functions in one unit:
 - Pick and place using vacuum pick-up
 - Dispensing of solder paste, flux, or adhesives
 - Soldering and desoldering of components
- Operates from inert gas or compressed air source
- All functions are activated with either hand or foot switch
- Compatible with Weller and Ungar soldering and desoldering irons
- Complete listing of nozzles for hot air pencil on page Weller 68
- Hot air pencil temperature control: 300°F - 1000°F
- Power supply: 145W
- Dimensions: 9.5" x 10.6" x 4.25"
- Current: 120V AC, 50-60 Hz
- Compressed air pressure required: 43.5 - 116.0 psi
- Hot air pencil: 100W
- Will accommodate optional Weller and Ungar soldering irons from 25 - 80W and desoldering irons from 50 - 80W

| Cat. No. | UPC No. | Description | Shelf Pack Wt. | | Shelf Pack |
|----------|--------------|--|----------------|-----|------------|
| | | | lb | kg | |
| WRS2000 | 037103125460 | Rework station with HAP1 hot air pencil, vacuum pick-up, dispensing, manual remote control, foot pedal, and stands | 16 | 7.3 | 1 |

WRS1000 rework station

Weller®



[查询"53002699"供应商](#)

- **Self-contained**, ESD-safe station designed to handle variety of rework and repair tasks
- Selector switch allows user to choose either selection of tools below or standard hot air tool supplied
- Input watts: 175w
- Temperature range: Hot air 300°F - 1000°F; Solder/Desolder 300°F - 850°F
- Compatible with Weller and Ungar soldering and desoldering irons
- Complete listing of nozzles for hot air pencil on page Weller 68



| Cat. No. | UPC No. | Description | Power Unit | | | Shelf Pack Wt. | | Shelf Pack |
|----------|--------------|---|------------|----|----|----------------|-----|------------|
| | | | V | W | Hz | lb | kg | |
| WRS1000 | 037103088499 | Rework station-Output 24v w/HAP1 Hot air pencil and stand | 120 | 60 | 60 | 12.85 | 5.8 | 1 |

Optional accessories:

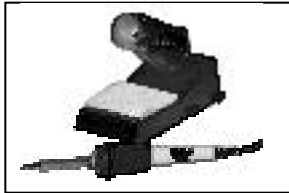

Catalog No.: **EC1201AP**
Soldering iron and stand
ETA tip



Catalog No.: **EC1302AP**
Soldering iron and stand
EPH101 tip



Catalog No.: **EC1503AP**
Soldering iron and stand
EMA tip



Catalog No.: **DS1203AP**
Desoldering tool and stand
DSH112 tiptlet



Catalog No.: **DS59**
Desoldering pistol and stand
4006 tiptlet

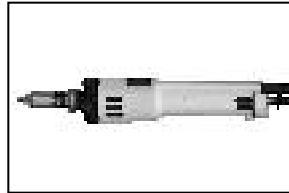

Catalog No.: **DS58**
Desoldering pencil and stand
- 4006 tiptlet



Catalog No.: **WST20**
Thermal stripper



Catalog No.: **WSS1**
Stand system w/stands.
Order iron holder and stands
separately



Catalog No.: **9911AS**
Micro-size iron - 24v,
9012 tip



Catalog No.: **9931AS**
Macro-size iron - 24v,
9960 tip



Catalog No.: **WHPS**
Preheat plate



Catalog No.: **ADP1**
Adapter for 9911AS, 9911HC,
9931AS, 5088AS, 5098AS



Catalog No.: **FS1**
Foot pedal

4924 series rework stations



查询"53002699"供应商



4924P

- **Self-contained**, ESD-safe rework station handles virtually all repair and rework applications, UL listed
- Temperature control for either of two anti-static desoldering handles; Temp. variation: 500°F - 850°F
- Temperature control for either one of two quick-connect 24VAC anti-static soldering irons; Temp, variation: 550°F - 850°F
- Desoldering vacuum switches to positive air flow for heat gun applications
- Power supply with three voltage ranges permits broad range use of optional tools
- Foot pedal switch or continuously powered machine center
- **#4924P** consists of: power base, 4310 machine center motor, 5098AS desoldering pistol, 9931AS macro soldering iron, 9911AS micro soldering iron, 8800 deluxe iron holder (shown)
- **#4924IL** same as #4924P but with 5088AS pencil-style desoldering iron in place of 5098AS pistol-style desoldering iron
- 4000 series tiptets listed on page Weller 74

| Cat. No. | UPC No. | Description | Power Unit | | | Shelf Pack Wt. | | Shelf Pack |
|----------|--------------|---------------------------|------------|-----|----|----------------|------|------------|
| | | | V | W | Hz | lb | kg | |
| 4924P | 037103088611 | Rework station-Output 24V | 120 | 480 | 60 | 17.70 | 8.00 | 1 |
| 4924IL | 037103088598 | Rework station-Output 24V | 120 | 480 | 60 | 17.70 | 8.00 | 1 |

The following is available only to authorized export distributors. Units not VDE or GS approved.

| | | | | | | | | |
|---------|--------------|---------------------------|-----|-----|-------|-------|------|---|
| 4924PD | 037103091871 | Rework station-Output 24V | 230 | 115 | 50/60 | 17.70 | 8.00 | 1 |
| 4924ILD | 037103091888 | Rework station-Output 24V | 230 | 115 | 50/60 | 17.70 | 8.00 | 1 |

Standard accessories:

For: 4924P, 4924IL

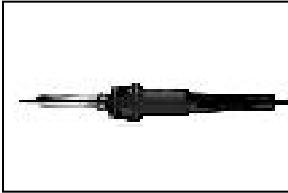

Catalog No.: **9931AS**
Macro-size iron - 24v,
9960 tip

For: 4924P

For: 4924P, 4924IL



Catalog No.: **9911AS**
Micro-size iron - 24v,
9012 tip

For: 4924IL



Catalog No.: **5098AS**
Pistol-style desoldering
tool - 24v, 4006 tiptet

For: 4924P, 4924IL



Catalog No.: **5088AS**
Pencil-style desoldering iron,
4006 tiptet

For: 4924P, 4924IL



Catalog No.: **4310**
Machine center motor for
milling, drilling and grinding



Catalog No.: **8800**
Iron holder assembly

Optional accessories:

For: 4924P, 4924IL



Catalog No.: **2003**
Foot pedal

For: 4924P, 4924IL



Catalog No.: **4912**
Thermal wire stripper (large)

For: 4924P, 4924IL

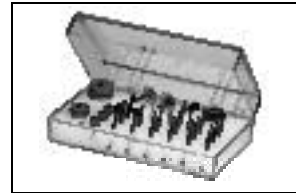

Catalog No.: **4911**
Accessory kit for 4310 motor

For: 4924P, 4924IL

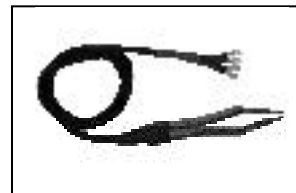

Catalog No.: **4913**
Resistance soldering
tweezers



[查询"53002699"供应商](#)

- **Self-contained**, ESD-safe soldering and desoldering system, UL listed and CUL-listed
- Operates either pencil or pistol-grip style desoldering handles. Temperature variation: 500°F - 850°F
- Also operates any one of two 24VAC quick-connect soldering irons. Temperature variation: 550°F - 850°F
- Rapid heat-up and vacuum response increases production (electronic repair, rework or modification)
- **#4624P** consists of: power base, 5098AS desoldering Pistol, 9931AS soldering iron, 400 sponge & tray (shown)
- **#4624IL** same as 4624P but with a 5088AS pencil-style desoldering iron in place of the 5098AS pistol-style desoldering iron
- SPEC. COMPLIANCE: MIL-STD-2000, DOD-STD-2000-1B, WS-6536E, MIL-S-46743E
- 4000 series tiptlets listed on page Weller 74



4624P

| Cat. No. | UPC No. | Description | Power Unit | | | Shelf Pack Wt. | | Shelf Pack |
|---|--------------|---------------------------|------------|-----|-------|----------------|------|------------|
| | | | V | W | Hz | lb | kg | |
| 4624P | 037103088628 | Rework station-Output 24V | 120 | 115 | 60 | 10.20 | 4.61 | 1 |
| 4624IL | 037103088635 | Rework station-Output 24V | 120 | 115 | 60 | 10.20 | 4.61 | 1 |
| The following is available only to authorized export distributors. Units not VDE or GS approved. | | | | | | | | |
| 4624PD | 037103091895 | Rework station-Output 24V | 230 | 115 | 50/60 | 10.20 | 4.61 | 1 |
| 4624ILD | 037103091901 | Rework station-Output 24V | 230 | 115 | 50/60 | 10.20 | 4.61 | 1 |

Standard accessories:

For: 4624P, 4624IL

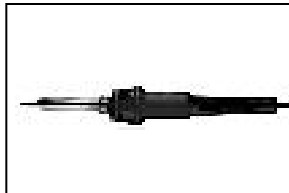

Catalog No.: **9931AS**
Macro-size iron - 24v

For: 4624P



Catalog No.: **5098AS**
Pisto-style desoldering iron, 4006 tiptlet

For: 4624IL



Catalog No.: **5088AS**
Pencil-style desoldering iron, 4006 tiptlet

For: 4624P, 4624IL



Catalog No.: **400**
Sponge and tray

Optional accessories:

For: 4624P, 4624IL



Catalog No.: **9911AS**
Micro-size iron - 24v, 9012 tip

4024 series rework stations



[查询"53002699"供应商](#)

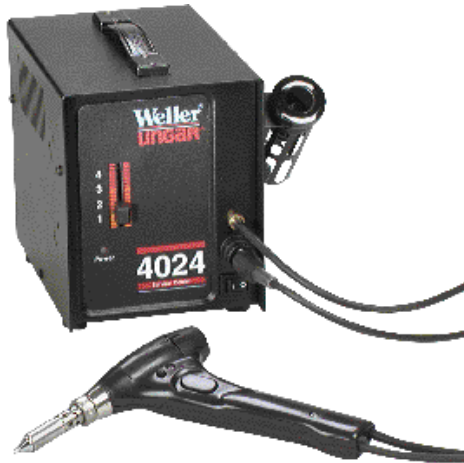

4024IL

- ESD-safe variable temperature, electronically controlled desoldering system (precise, closed loop electronic control)
- Totally **self-contained with internal pump**
- Operates pencil or pistol-grip style anti-static desoldering handle. Temperature variation: 500°F-850°F
- Designed for continuous production use
- **#4024P** consists of: power base, 5098AS pistol-style desoldering iron
- **#4024IL** consists of: power base, 5088AS pencil-style desoldering iron (shown)
- SPEC. COMPLIANCE: MIL-STD-2000, DOD-STD-2000-1B, WS-6536E, MIL-S-45743E
- 4000 series tiptets listed on page Weller 74
- UL listed

| Cat. No. | UPC No. | Description | Power Unit | | | Shelf Pack Wt. | | Shelf Pack |
|---|--------------|---------------------------|------------|-----|-------|----------------|------|------------|
| | | | V | W | Hz | lb | kg | |
| 4024P | 037103088550 | Rework station-Output 24V | 120 | 60 | 60 | 9.10 | 4.11 | 1 |
| 4024IL | 037103088574 | Rework station-Output 24V | 120 | 60 | 60 | 9.10 | 4.11 | 1 |
| The following is available only to authorized export distributors. Units not VDE or GS approved. | | | | | | | | |
| 4024PD | 037103091918 | Rework station-Output 24V | 230 | 115 | 50/60 | 9.10 | 4.11 | 1 |
| 4024ILD | 037103091925 | Rework station-Output 24V | 230 | 115 | 50/60 | 9.10 | 4.11 | 1 |



Catalog No.: **4024P**
5098AS pistol-style desoldering iron

For: 4024P



Catalog No.: **5098AS**
Pistol-style desoldering iron, 4006 tiptet

For: 4024IL



Catalog No.: **5088AS**
Pencil-style desoldering iron, 4006 tiptet

2024 series rework stations



[查询"53002699"供应商](#)

- ESD-safe desoldering system **utilizes shop air**
- Operates with either pencil or pistol-grip style anti-static handle
- Temperature variation: 500°F - 850°F
- Used for electronic repair, rework or modification
- Rapid heat-up and vacuum response increases production
- **#2024P** consists of power base, 5098AS pistol-style desoldering iron (shown)
- **#2024IL** consists of power base, 5088AS pencil-style desoldering iron
- SPEC. COMPLIANCE: MIL-STD-2000, DOD-STD-2000-1B, WS-6536E, MIL-S-45743E
- UL listed
- 4000 series tiptlets listed on page Weller 74



| Cat. No. | UPC No. | Description | Power Unit | | | Shelf Pack Wt. | | Shelf Pack |
|---|--------------|---------------------------|------------|----|-------|----------------|------|------------|
| | | | V | W | Hz | lb | kg | |
| 2024P | 037103088567 | Rework station-Output 24V | 120 | 60 | 60 | 8.60 | 3.89 | 1 |
| 2024IL | 037103088543 | Rework station-Output 24V | 120 | 60 | 60 | 8.60 | 3.89 | 1 |
| The following is available only to authorized export distributors. Units not VDE or GS approved. | | | | | | | | |
| 2024PD | 037103091932 | Rework station-Output 24V | 230 | 60 | 50/60 | 8.60 | 3.89 | 1 |
| 2024ILD | 037103091949 | Rework station-Output 24V | 230 | 60 | 50/60 | 8.60 | 3.89 | 1 |



Catalog No.: **2024IL**
5088AS pencil-style desoldering iron

For: 2024P



Catalog No.: **5098AS**
Pistol-style desoldering iron, 4006 tiplet

For: 2024IL



Catalog No.: **5088AS**
Pencil-style desoldering iron, 4006 tiplet

Temperature controlled rework stations accessories

| Cat. No. | No. | Description | Power Unit | | | Shelf Pack Wt. | | Shelf Pack |
|----------|--------------|---|------------|-----|----|----------------|-------|------------|
| | | | V | W | Hz | lb | kg | |
| HAP1 | 037103088314 | Hot air pencil and stand | 24 | 100 | - | 1.896 | 0.86 | 1 |
| WHPS | 037103088352 | Preheat plate 24v, 50 watt | 24 | 50 | - | 1.51 | 0.684 | 1 |
| WSS1 | 037103102508 | Weller Stand System w/o stands or holder | - | - | - | 4.300 | 1.95 | 1 |
| EC1201AP | 037103088376 | 40w Soldering iron w/ETA tip and stand | 24 | 40 | - | 0.37 | 0.16 | 1 |
| EC1302AP | 037103088383 | 20w iron w/EPH101 tip and stand | 24 | 20 | - | 0.31 | 0.14 | 1 |
| EC1503AP | 037103088451 | 42w Soldering iron w/EMAtip and stand | 24 | 42 | - | 0.31 | 0.14 | 1 |
| DS1203AP | 037103088291 | Desoldering tool w/DSH112 tiptet and stand | 24 | 54 | - | 0.31 | 0.14 | 1 |
| 5098AS | 037103059758 | Desolder pistol, high performance | 24 | 60 | - | 1.061 | .481 | 1 |
| DS59 | 037103089205 | High-performance desolder pistol | 24 | 60 | - | .581 | .263 | 1 |
| 5088AS | 037103088239 | Inline desoldering iron, high performance | 24 | 60 | - | .487 | .220 | 1 |
| DS58 | 037103089212 | High-performance desolder pencil | 24 | 60 | - | .581 | .263 | 1 |
| 9911AS | 037103035530 | Micro-size iron w/9012 tip | 24 | 40 | - | 0.37 | 0.16 | 1 |
| 9931AS | 037103035646 | Macro-size iron w/9960 tip | 24 | 60 | - | 0.37 | 0.16 | 1 |
| WST20 | 037103088475 | Thermal stripper, no blades | - | - | - | .643 | .291 | 1 |
| 58725726 | 037103088253 | Blade styles for: AWG 12, 16, 24 | - | - | - | 0.63 | 0.28 | 1 |
| 58725729 | 037103088260 | Blade styles for: AWG 12, 14, 16, 24 | - | - | - | 0.63 | 0.28 | 1 |
| 58725732 | 037103088277 | Blade styles for: AWG 14, 18, 22, 26 | - | - | - | 0.63 | 0.28 | 1 |
| 58725718 | 037103088246 | Flat cable stripper | - | - | - | 0.063 | 0.028 | 1 |
| 58725723 | 037103088444 | Cutting knives | - | - | - | 0.063 | 0.028 | 1 |
| 4912 | 037103033925 | Thermal wire strippers (large) | 0-3 | - | - | .800 | .362 | 1 |
| 4913 | 037103033932 | Resistance soldering tweezers | 0-3 | - | - | .493 | .223 | 1 |
| 8800 | 037103030993 | Deluxe iron holder | - | - | - | 4.30 | 1.94 | 1 |
| 400 | 037103030368 | Kleen-tip sponge and tray | - | - | - | 0.93 | 0.42 | 1 |
| 2003 | 037103031150 | Foot pedal | - | - | - | 1.084 | .491 | 1 |
| 4310 | 037103032591 | Machine center motor | 24 | - | - | 0.75 | 0.34 | 1 |
| 4911 | 037103033918 | Accessory kit for 4310 machine center motor | - | - | - | .564 | .255 | 1 |
| FS1 | 037103088468 | Foot pedal | - | - | - | .044 | .020 | 1 |
| ADP1 | 037103089526 | Ungar tool adapter for WRS 3000 or WRS 1000 | - | - | - | .120 | .054 | 1 |
| 4914 | 037103033949 | TRAC-AID kit (see below for list) | - | - | - | - | - | 1 |
| 4375 | 037103032867 | Optional accessory package (see below) | - | - | - | - | - | 1 |

#4914 includes: 25 each Eyelets with shank sizes .050, .062, .088, .093, .118

#4375 includes: 4310, 4911, 4912, 4913, 4914, desoldering tiptet assortment

Continued on next page.

Temperature controlled rework stations accessories - continued

[查询"53002699"供应商](#)



Catalog No.: **HAP1**
Hot air pencil and stand



Catalog No.: **WHPS**
Preheat plate



Catalog No.: **WSS1**
Stand system w/stands.
Order iron holder and stands separately

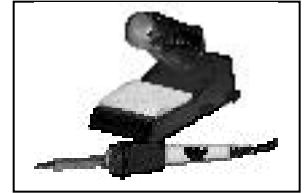

Catalog No.: **EC1201AP**
40W Soldering iron and stand,
ETA tip



Catalog No.: **EC1302AP**
20W Soldering iron and stand,
EPH101 tip



Catalog No.: **EC1503AP**
42W Soldering iron and stand,
EMA tip

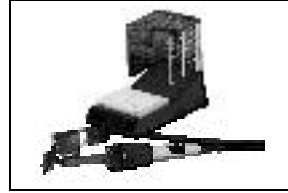

Catalog No.: **DS1203AP**
54W Desoldering tool and
stand, DSH112 tiptlet



Catalog No.: **5098AS**
Pistol-style desoldering iron,
4006 tiptlet



Catalog No.: **DS59**
Desoldering pistol and
stand, 4006 tiptlet



Catalog No.: **5088AS**
Pencil-style desoldering iron,
4006 tiptlet



Catalog No.: **DS58**
Desoldering pencil and
stand, 4006 tiptlet



Catalog No.: **9911AS**
Micro-size iron-24v,
9012 tiptlet

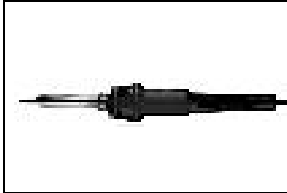

Catalog No.: **9931AS**
Macro-size iron-24v,
9960 tiptlet



Catalog No.: **WST20**
Thermal stripper



Catalog No.: **4912**
Thermal wire stripper (large)



Catalog No.: **4913**
Resistance soldering
tweezers



Catalog No.: **8800**
Iron holder assembly



Catalog No.: **400**
Sponge and tray



Catalog No.: **2003**
Foot pedal



Catalog No.: **4310**
Machine center motor for
milling, drilling and grinding



Catalog No.: **4911**
Accessory kit for 4310 motor



Catalog No.: **FS1**
Foot pedal



Catalog No.: **ADP1**
Adapter for 9911AS, 9911HC,
9931AS, 5088AS, 5098AS

Manual desoldering tools

DS40 desoldering/repair tool

[查询"53002699"供应商](#)



- Valuable repair tool for servicing printed circuit boards and solid state electronics
- Allows components to be removed and replaced quickly with less chance of heat damage
- Complete unit includes 40w tool, vacuum bulb, desoldering assembly with DST4 tiplet
- See page Weller 74 for tiplets
- UL listed

| Cat. No. | UPC No. | Description | V | W | Hz | Shelf Pack Wt. | | Shelf Pack |
|----------|--------------|------------------------------|-----|----|----|----------------|------|------------|
| | | | | | | lb | kg | |
| DS40 | 037103000941 | Desoldering/repair tool | 120 | 40 | 60 | 3.25 | 1.47 | 6 |
| DSH40 | 037103473813 | Head assembly w/DST-4 tiplet | | | | 0.25 | 0.11 | 1 |

WDP series manual desoldering pumps



- Removes molten solder from printed circuit boards and electronic components
- Plunger seal spring creates extremely strong suction
- Tool features push button plunger release and lightweight aluminum body that withstands high temperatures
- Tips unscrew to allow easy removal of accumulated solder debris
- Standard and Teflon* tips are available. (* Teflon is a registered Trademark of DuPont)
- See page Weller 74 for tiplets

| Cat. No. | UPC No. | Description | Shelf Pack Wt. | | Shelf Pack |
|--------------------------|--------------|---|----------------|------|------------|
| | | | lb | kg | |
| WDP07 | 037103480620 | Desoldering pump w/0.07" tip | 1.00 | 0.45 | 6 |
| WDP07A | 037103480637 | Desoldering pump-Antistatic w/0.07" tip | 1.00 | 0.45 | 6 |
| WDP12 | 037103480590 | Desoldering pump w/0.12" tip | 1.00 | 0.45 | 6 |
| WDP12A | 037103480613 | Desoldering pump-Antistatic w/0.12" tip | 1.00 | 0.45 | 6 |
| Replacement parts | | | | | |
| WDPSPK07 | 037103480712 | Spare parts kit/0.7" tip | 0.43 | 0.19 | 6 |
| WDPSPK12 | 037103480705 | Spare parts kit/.12" tip | 0.43 | 0.19 | 6 |

DSTCP Desoldering adapter



- Attaches to TC201 series irons
- Permits operator to desolder and resolder with same tool
- Wide range of desoldering tiplets available, see page Weller 74

| Cat. No. | UPC No. | Description | Shelf Pack Wt. | | Shelf Pack |
|----------|--------------|---------------------|----------------|------|------------|
| | | | lb | kg | |
| DSTCP | 037103472007 | Desoldering adapter | 0.25 | 0.11 | 1 |

DS60 Desoldering adapter

- Versatile attachment for W60P series iron
- Permits operator to desolder and resolder with same tool
- Wide range of desoldering tiptets available, see page Weller 73



| Cat. No. | UPC No. | Description | Shelf Pack Wt. | | Shelf Pack |
|----------|--------------|---------------------|----------------|------|------------|
| | | | lb | kg | |
| DS60 | 037103473974 | Desoldering adapter | 1.25 | 0.56 | 6 |



Surface mount products Hot air rework systems WHA700

- Precise temperature control reduces amount of time boards and surrounding components are subjected to thermal stress
- Operates without expensive air pumps, allowing an inexpensive and simple way to rework and repair boards (requires compressed air or nitrogen)
- Adapters allow the use of other manufacturers' nozzles
- Precisely replaces chips as small as 5 mil pitch
- Built-in vacuum pick-up. No guessing when chip is ready for removal
- Complete range of nozzles available - see page Weller 67
- Hand tool 700/750W Anti-static, double insulated cable
- Power supply: 120V, 50/60Hz
- Air flow: a supply of air flow (or inert gas) from an external source is required 50 - 90psi. Continuously adjustable from 10 - 50 liters/min
- Air temp: 122°F - 1022°F ±86°F
- Vacuum: created by venturi tube from external air supply
- Standard equipment: power unit, hand piece, tool holder, and foot switch
- Accessories: 31 interchangeable nozzles



| Cat. No. | UPC No. | Description | Shelf Pack Wt. | | Shelf Pack |
|----------|--------------|----------------------------|----------------|-----|------------|
| | | | lb | kg | |
| WHA700 | 037103129666 | SMT Hot Air Rework Station | 11.8 | 5.4 | 1 |

WHA2000

[查询"53002699"供应商](#)



- Self contained, ESD-safe hot air and SMD rework station
- Adjustable air flow and temperature
- Adapters allow the use of other manufacturers' nozzles
- Precisely replaces chips as small as 5 mil pitch
- Built-in vacuum pick-up. No guessing when chip is ready for removal
- Complete range of nozzles available - see page Weller 67
- Hand tool 700/750W Anti-static, double insulated cable
- Power supply: 120V, 50/60Hz
- Air flow: self-contained air source generates its own air flow. Continuously adjustable from 10 - 50 liters/min
- Air temp: 122°F - 1022°F ±86°F
- Vacuum: -0.6 bar (17.7" mercury) created by built-in reciprocating pump
- Standard equipment: power unit, hand piece, tool holder, and foot switch
- Accessories: 31 interchangeable nozzles

| Cat. No. | UPC No. | Description | Shelf Pack Wt. | | Shelf Pack |
|----------|--------------|---|----------------|-----|------------|
| | | | lb | kg | |
| WHA2000 | 037103107241 | Self Contained SMT Hot Air Rework Station | 20.3 | 9.2 | 1 |

Hot-Air-System-electronically controlled



- Ideal, compact design for reflow soldering, desoldering and rework in series production when using surface mounted components
- Consists of supply unit controlling infinitely variable hot gas flow and temperature
- Hot gas pencil with temperature resistant connection tube and pencil holder
- Electronically controlled temperature of low voltage pencil can be set from 122°F (50°C) to 1022°F (550°C)
- Unit requires compressed shop air/Inert gas (Nitrogen)
- Foot pedal activates non-static gas flow, enabling operator to solder/desolder even ESD sensitive components w/o risk of electro-static damage
- Temperature control with zero voltage crossing switch
- Infinitely variable gas flow

| Cat. No. | UPC No. | Description | V | W | Hz | Shelf Pack Wt. | | Shelf Pack |
|----------|--------------|------------------|-----|----|-------|----------------|------|------------|
| | | | | | | lb | kg | |
| AG75 | 037103041593 | Complete station | 120 | 75 | 50/60 | 5.50 | 2.48 | 1 |

Accessory products-electronic soldering stations WCM1 system calibration unit

[查询"53002699"供应商](#)

- Designed to work with EC2002M series soldering stations
- Unit plugs in between station and soldering iron
- Allows user to calibrate tip temperature of soldering iron to outside temperature reference
- Enables timer setback mode (Allows station to set back to 350°F after period of inactivity)
- Insert fixed temperature into station and turning off front panel control knob
- Switching station display between °F and °C
- Resetting station electronics to original factory calibration
- Unit uses four "AA" alkaline batteries for power (included)
- 3 months normal life expectancy of batteries
- 16 button keypad
- Three digit LED display
- Connectors to attach to soldering station and iron



| Cat. No. | UPC No. | Description | Shelf Pack Wt. | | Shelf Pack |
|----------|--------------|------------------|----------------|------|------------|
| | | | lb | kg | |
| WCM1 | 037103089519 | Calibration unit | 0.50 | 0.23 | 1 |

WC5000 system calibration unit

- Calibration unit for use with MC5000 and MC5001 microprocessor controlled soldering system
- Unit MUST be used in conjunction with calibration checks and procedures listed in tech sheet supplied with soldering unit



| Cat. No. | UPC No. | Description | Shelf Pack Wt. | | Shelf Pack |
|----------|--------------|------------------|----------------|------|------------|
| | | | lb | kg | |
| WC5000 | 037103591821 | Calibration unit | 0.25 | 0.11 | 1 |

WC1000 and WC3000 system calibration units

- WC1000 calibration unit for use with EC1000/1001, EC2000/2001, DEC1001, EC1002 and EC2002 series electronic soldering systems
- WC3000 calibration unit for use with E3000/3001, EC4000/4001 series electronic soldering systems
- Units MUST be used in conjunction with calibration checks and procedures listed in tech sheet supplied with soldering unit



| Cat. No. | UPC No. | Description | Shelf Pack Wt. | | Shelf Pack |
|----------|--------------|------------------|----------------|------|------------|
| | | | lb | kg | |
| WC1000 | 037103480569 | Calibration unit | 0.25 | 0.11 | 1 |
| WC3000 | 037103480576 | Calibration unit | 0.25 | 0.11 | 1 |

WA2000 soldering iron analyzer

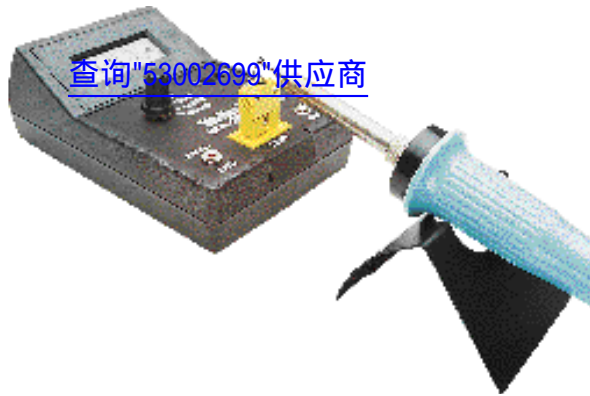

- Portable unit with battery life of 50 hours
- Checks either temperature stability using contact pyrometer or absolute temperature when measured with preconnected thermocouple assembly
- Use contact pyrometer for monitoring stability to Mil-STD-2000 specification
- Accurately measures iron resistance from tip to ground post on plug
- Tip to ground noise induced by iron: low level voltage measurable from working area of tip to ground

| Cat. No. | UPC No. | Description | Shelf Pack Wt. | | Shelf Pack |
|--------------------------|--------------|---------------------------------------|----------------|------|------------|
| | | | lb | kg | |
| WA2000 | 037103592354 | Soldering iron analyzer | 0.50 | 0.22 | 1 |
| Replacement parts | | | | | |
| CP01 | 037103592361 | Contact pyrometer, large gauge | - | - | 1 |
| CP02 | 037103592378 | Contact pyrometer, small gauge | - | - | 1 |
| K111 | 037103592380 | Type K thermocouple assy., ETA tip | - | - | 1 |
| K121 | 037103592392 | Type K thermocouple assy., EPH107 tip | - | - | 1 |
| K131 | 037103592750 | Type K thermocouple assy., EMAtip | - | - | 1 |
| K141 | 037103592743 | Type K thermocouple assy., WCC100 tip | - | - | 1 |

Accessory products - Iron stands PH2000



- Universal stand for holding soldering irons, desoldering irons, hot air irons

| Cat. No. | UPC No. | Description | Shelf Pack Wt. | | Shelf Pack |
|----------|--------------|---------------------|----------------|------|------------|
| | | | lb | kg | |
| PH2000 | 037103102492 | Iron stand assembly | 0.75 | 0.33 | 1 |

PH1201ESD

- Soldering tool stand with base, sponge and receptacle
- For EC1201P, EC1201PESD, EC1201A, TC201P, EC201P, EC201PESD, EC201A, TC201P, EC201R, EC201RES, EC201S, EC201S101P irons

[查询"5302690"供应商](#)



| Cat. No. | UPC No. | Description | Shelf Pack Wt. | | Shelf Pack |
|-----------|--------------|---------------------|----------------|------|------------|
| | | | lb | kg | |
| PH1201ESD | 037103591135 | Iron stand assembly | 0.75 | 0.33 | 1 |

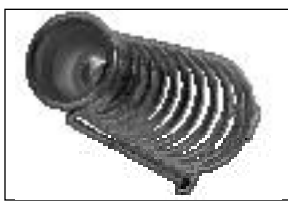

Catalog No.: **TC204**
Spring and funnel assembly



Catalog No.: **TC205**
Sponge

PH1301ESD

- Soldering tool stand with base, sponge and receptacle
- For EC1301, EC1301ESD, EC1301R, EC1302, EC1302R, EC1302A, WM120 irons



| Cat. No. | UPC No. | Description | Shelf Pack Wt. | | Shelf Pack |
|-----------|--------------|---------------------|----------------|------|------------|
| | | | lb | kg | |
| PH1301ESD | 037103591128 | Iron stand assembly | 0.75 | 0.33 | 1 |



Catalog No.: **IHF225EC**
Spring and funnel assembly



Catalog No.: **TC205**
Sponge

PH1503

[查询"53002699"供应商](#)



- Soldering tool stand with base, sponge and receptacle
- For EC1503, EC1503R, EC1503A irons

| Cat. No. | UPC No. | Description | Shelf Pack Wt. | | Shelf Pack |
|----------|--------------|---------------------|----------------|------|------------|
| | | | lb | kg | |
| PH1503 | 037103043931 | Iron stand assembly | 0.75 | 0.33 | 1 |



Catalog No.: **EC254**
Spring and funnel assembly



Catalog No.: **TC205**
Sponge

PH60



- Soldering tool stand with base, sponge and receptacle
- For W60P and "WP" series irons and irons with barrel diameter up to 15/32"/11.90 mm

| Cat. No. | UPC No. | Description | Shelf Pack Wt. | | Shelf Pack |
|----------|--------------|---------------------|----------------|------|------------|
| | | | lb | kg | |
| PH60 | 037103474018 | Iron stand assembly | 11.50 | 5.20 | 6 |

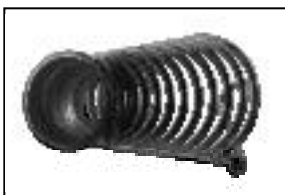

Catalog No.: **SFA60**
Spring and funnel assembly



Catalog No.: **TC205**
Sponge

- Soldering tool stand with base, sponge and receptacle for W100F9 iron and irons with barrel diameter up to 19/32"/15.08 mm



| Cat. No. | UPC No. | Description | Shelf Pack Wt. | | Shelf Pack |
|----------|--------------|---------------------|----------------|------|------------|
| | | | lb | kg | |
| PH100 | 037103474209 | Iron stand assembly | 11.50 | 5.20 | 6 |

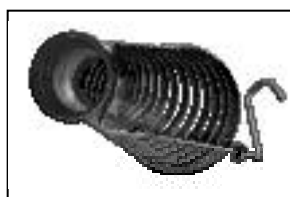

Catalog No.: **SFA100**
Spring and funnel assembly



Catalog No.: **TC205**
Sponge

KH25P

- Soldering tool stand with base, sponge and receptacle
- For MPR30 iron



| Cat. No. | UPC No. | Description | Shelf Pack Wt. | | Shelf Pack |
|----------|--------------|---------------------|----------------|------|------------|
| | | | lb | kg | |
| KH25P | 037103049179 | Iron stand assembly | 0.50 | 0.22 | 1 |

PH1201FE

- Fume extraction soldering tool stand with base, sponge and receptacle
- For TC201FE, EC1201FE, EC1201AFE irons



| Cat. No. | UPC No. | Description | Shelf Pack Wt. | | Shelf Pack |
|----------|--------------|---------------------|----------------|------|------------|
| | | | lb | kg | |
| PH1201FE | 037103043948 | Iron stand assembly | 0.75 | 0.33 | 1 |



Catalog No.: **RSFFE**
Spring and funnel assembly



Catalog No.: **TC205**
Sponge

PH1302FE



- Fume extraction soldering tool stand with base, sponge and receptacle
- Use when combining an EC1302A, EC1301, EC1301R, EC1302, EC1301ESD micro irons with an ECMFE fume extraction clip attachment

| Cat. No. | UPC No. | Description | Shelf Pack Wt. | | Shelf Pack |
|----------|--------------|---------------------|----------------|------|------------|
| | | | lb | kg | |
| PH1302FE | 037103043924 | Iron stand assembly | 0.75 | 0.33 | 1 |



Catalog No.: **RSFMFE**
Spring and funnel assembly



Catalog No.: **TC205**
Sponge

TC204 spring and funnel assembly

- To attach to tool stand, wall or bench
- For EC1201A, EC1201P, EC1201PESD, TC201T, TC201P, TC201PZ, DS101P irons

查询: 53002899 供应商



| Cat. No. | UPC No. | Description | Shelf Pack Wt. | | Shelf Pack |
|----------|--------------|----------------------------|----------------|------|------------|
| | | | lb | kg | |
| TC204 | 037103475169 | Spring and funnel assembly | 0.25 | 0.11 | 1 |

IHF225EC spring and funnel assembly

- To attach to tool stand, wall or bench
- For EC1302A, EC1302, EC1301, EC1301ESD, EC1302R, EC1301R, WM120, irons



| Cat. No. | UPC No. | Description | Shelf Pack Wt. | | Shelf Pack |
|----------|--------------|----------------------------|----------------|------|------------|
| | | | lb | kg | |
| IHF225EC | 037103476920 | Spring and funnel assembly | 0.25 | 0.11 | 1 |

EC254 spring and funnel assembly

- To attach to tool stand, wall or bench
- For EC1503A, EC1503, EC1503R irons



| Cat. No. | UPC No. | Description | Shelf Pack Wt. | | Shelf Pack |
|----------|--------------|----------------------------|----------------|------|------------|
| | | | lb | kg | |
| EC254 | 037103591999 | Spring and funnel assembly | 0.37 | 0.16 | 1 |

RSFFE, RSFMFE spring and funnel assembly

[查询"53002699"供应商](#)



- To attach to tool stand, wall or bench
- #AKFE1-1 fume extraction kit for TC201FE, EC1201AFE, EC1201FE (RSFFE) irons
- Also for irons fitted with Weller #ECMFE clip (RSFMFE) attachment

| Cat. No. | UPC No. | Description | Shelf Pack Wt. | | Shelf Pack |
|----------|--------------|----------------------------|----------------|------|------------|
| | | | lb | kg | |
| RSFFE | 037103592316 | Spring and funnel assembly | 0.37 | 0.16 | 1 |
| RSFMFE | 037103004314 | Spring and funnel assembly | 0.37 | 0.16 | 1 |

SFA60 spring and funnel assembly



- To attach to tool stand, wall or bench
- For PH60 tool stand. W60P, "WP" series irons and irons with barrel diameter up to 15/32"/11.90 mm

| Cat. No. | UPC No. | Description | Shelf Pack Wt. | | Shelf Pack |
|----------|--------------|----------------------------|----------------|------|------------|
| | | | lb | kg | |
| SFA60 | 037103474049 | Spring and funnel assembly | 2.75 | 1.24 | 6 |

SFA100 spring and funnel assembly



- To attach to tool stand, wall or bench
- For PH100 tool stand. W100PG and irons with barrel diameter up to 19/32"/15.08 mm

| Cat. No. | UPC No. | Description | Shelf Pack Wt. | | Shelf Pack |
|----------|--------------|----------------------------|----------------|------|------------|
| | | | lb | kg | |
| SFA100 | 037103474216 | Spring and funnel assembly | 2.75 | 1.24 | 6 |

TC205 and EC305 sponges

- One standard size fits all Weller soldering and

[desoldering tool stands](#)
[查询"5800209"供应商](#)



TC205



EC305

| Cat. No. | UPC No. | Description | Shelf Pack Wt. | | Shelf Pack |
|----------|--------------|-------------------------------|----------------|------|------------|
| | | | lb | kg | |
| TC205 | 037103475176 | Sponge for tool stand | 0.37 | 0.16 | 10 |
| EC305 | 037103104670 | Sponge w/holes for tool stand | 0.25 | 0.11 | 10 |

DS2010

- Desoldering tool stand with base, sponge and holder
- For all Weller desoldering irons



Catalog No.: **TC205**
Sponge

| Cat. No. | UPC No. | Description | Shelf Pack Wt. | | Shelf Pack |
|----------|--------------|---------------------------------|----------------|------|------------|
| | | | lb | kg | |
| DS2010 | 037103480125 | Desoldering iron stand assembly | 0.75 | 0.33 | 1 |

Accessory Products - Miscellaneous ECMFE, MSFE clip attachments

[查询"53002699"供应商](#)



- Clip attachment to convert Weller EC1302 and EC1503 series soldering irons for use with Weller® Fumex® system
- Kit contains:
 - 1 ea - FUME ATTACHMENT ASSEMBLY
 - 1 ea - FE MINI FUNNEL
 - 5 ea - DS CLIPS
 - 1 ea - SPRING SHIELD
 - 7 ft - BLACK ESD TUBING
 - 1 ea - HOSE COUPLING
 - 1 ea - TUBE CLEANING BRUSH
- See iron fume extraction adapter kit table on page Weller 27

| Cat. No. | UPC No. | Description | Shelf Pack Wt. | | Shelf Pack |
|----------|--------------|--|----------------|------|------------|
| | | | lb | kg | |
| ECMFE | 037103028167 | Fumex clip attachment/irons | 0.25 | 0.11 | 1 |
| MSFE | 037103043665 | Fumex clip attachment/irons for Microsol, Microtouch irons | 0.25 | 0.11 | 1 |

AKFE series Fume Extraction Kits



- Fume extraction kit converts existing standard and micro irons for use with Weller® Fumex® system
- Variety of available models
- Complete with plastic tubing
- Detailed operating instructions included
- See iron fume extraction adapter kit table on page Weller 27

| Cat. No. | UPC No. | Description | Shelf Pack Wt. | | Shelf Pack |
|----------|--------------|--|----------------|------|------------|
| | | | lb | kg | |
| AKFE1 | 037103240713 | Fume extraction kit - Hex, Pace, ESD | 0.25 | 0.11 | 1 |
| AKFE11 | 037103060600 | Fume extraction kit - W100PG, WP25, WP40 | 0.25 | 0.11 | 1 |
| AKFE2 | 037103044662 | Fume extraction kit - Hakko 900 series | 0.25 | 0.11 | 1 |
| AKFE3 | 037103060631 | Fume extraction kit - WP25-35, Jensen 47B723 | 0.25 | 0.11 | 1 |
| AKFE4 | 037103060648 | Fume extraction kit - SI325, 500, 2110, 5550 | 0.25 | 0.11 | 1 |
| AKFE5 | 037103060617 | Fume extraction kit - EDSYN 951, 930 | 0.25 | 0.11 | 1 |
| AKFE6 | 037103060693 | Fume extraction kit - 9910, 9941AS, UTC200 | 0.25 | 0.11 | 1 |

ESF120, ESF120ESD (ESD safe)

- Complete work center for placing, soldering and desoldering printed circuit boards
- Spring clamps hold workpiece in place
- Rotates through 360°, allowing work performance at any convenient angle
- Adjustable features allow handling of variety of circuit board sizes
- Socket key included
- Maximum surface: 6-1/4"/160 mm x 9-1/8"/235 mm
- ESF120ESD is ESD SAFE

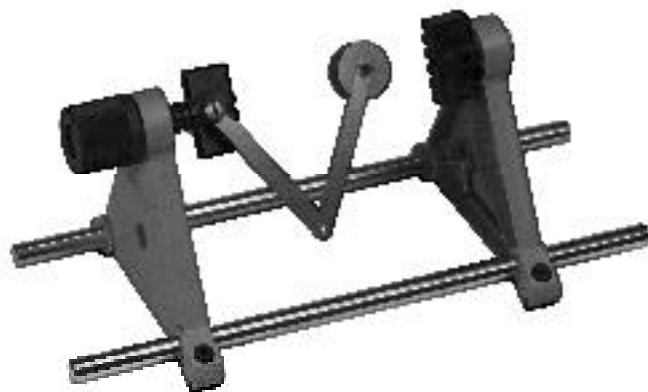

| Cat. No. | UPC No. | Description | Shelf Pack Wt. | | Shelf Pack |
|-----------|--------------|---------------------------------|----------------|------|------------|
| | | | lb | kg | |
| ESF120 | 037103592675 | Vise for holding circuit boards | 2.5 | 1.13 | 1 |
| ESF120ESD | 037103045041 | Vise for holding circuit boards | 2.5 | 1.13 | 1 |

AC303P

- Ideal for electronic kit building or electrical work
- Use bulb with any Weller® soldering iron
- Highly resistant material tip will not scratch delicate PC boards
- Carded



| Cat. No. | UPC No. | Description | Shelf Pack Wt. | | Shelf Pack |
|----------|--------------|------------------|----------------|------|------------|
| | | | lb | kg | |
| AC303P | 037103475398 | Desoldering bulb | 1.25 | 0.56 | 1 |

Lead free solder



AC1251



SW1251

[查询"53002699"供应商](#)

- Alloy: 100% lead free, melts at 415°F
- Acid Core, Rosin Core and Solid Wire Solder can be ordered carded
- Acid Core and Solid Wire solder can be ordered bulk
- Important warnings in both English and Spanish on back of each package
- Helpful soldering directions on back of cards

| Cat. No. | UPC No. | Description | Shelf Pack Wt. | | Shelf Pack |
|--------------------------------------|--------------|---------------------------------|----------------|------|------------|
| | | | lb | kg | |
| Acid core solder - Carded | | | | | |
| AC0621 | 037103083128 | 0.062" Acid core solder, 1 oz. | 0.5 | 0.23 | 6 |
| AC0624 | 037103083111 | 0.062" Acid core solder, 4 oz. | 2.5 | 1.13 | 6 |
| AC1251 | 037103083081 | 0.125" Acid core solder, 1 oz. | 0.5 | 0.23 | 6 |
| AC1254 | 037103083074 | 0.125" Acid core solder, 4 oz. | 2.5 | 1.13 | 6 |
| Acid core solder - Bulk pack | | | | | |
| AC0621L | 037103083098 | 0.062" Acid core solder, 1 lb. | 10.5 | 4.76 | 10 |
| AC0628 | 037103083104 | 0.062" Acid core solder, 8 oz. | 5.5 | 2.49 | 10 |
| AC1251L | 037103083043 | 0.125" Acid core solder, 1 lb. | 10.5 | 4.76 | 10 |
| AC1258 | 037103083050 | 0.125" Acid core solder, 8 oz. | 5.5 | 2.49 | 10 |
| Rosin core solder - Carded | | | | | |
| RC0501 | 037103083036 | 0.05" Rosin core solder, 1 oz. | 0.5 | 0.23 | 6 |
| RC0504 | 037103083029 | 0.05" Rosin core solder, 4 oz. | 2.5 | 1.13 | 6 |
| RC0621 | 037103083012 | 0.062" Rosin core solder, 1 oz. | 0.5 | 0.23 | 6 |
| RC0624 | 037103083005 | 0.062" Rosin core solder, 4 oz. | 2.5 | 1.13 | 6 |
| Solid wire solder - Carded | | | | | |
| SW0621 | 037103082992 | 0.062" Solid wire solder, 1 oz. | 0.5 | 0.23 | 6 |
| SW0624 | 037103082985 | 0.062" Solid wire solder, 4 oz. | 2.5 | 1.13 | 6 |
| SW1251 | 037103082954 | 0.125" Solid wire solder, 1 oz. | 0.5 | 0.23 | 6 |
| SW1254 | 037103082947 | 0.125" Solid wire solder, 4 oz. | 2.5 | 1.13 | 6 |
| Solid wire solder - Bulk pack | | | | | |
| SW0621L | 037103082961 | 0.062" Solid wire solder, 1 lb. | 10.5 | 4.76 | 10 |
| SW0628 | 037103082978 | 0.062" Solid wire solder, 8 oz. | 5.5 | 2.49 | 10 |
| SW1251L | 037103082923 | 0.125" Solid wire solder, 1 lb. | 10.5 | 4.76 | 10 |
| SW1258 | 037103082930 | 0.125" Solid wire solder, 8 oz. | 5.5 | 2.49 | 10 |

Lead free solder kits

[查询"53002699"供应商](#)

- Products in clean, clear, easy-to-read packaging
- Complete instructions on back of packaging
- Important warnings on back of packaging in both English and Spanish
- Kits for both Professional and Do it yourselfer



KFB



KPLUMB



KSILVER



KSPS



K3B

| Cat. No. | UPC No. | Description | Shelf Pack Wt. | | Shelf Pack |
|----------|--------------|--|----------------|------|------------|
| | | | lb | kg | |
| KFB | 037103083173 | 0.35 oz. Flux in tube w/ brush, carded | 0.70 | 0.32 | 6 |
| KPLUMB | 037103083142 | 4 oz. Solid wire plumber's solder, 2 oz. flux, brush, abrasive cloth, carded | 3.00 | 1.36 | 6 |
| KSILVER | 037103083135 | 1 oz. Silver solder, 0.35 oz. flux in tube, carded | 1.00 | 0.45 | 6 |
| KSPS | 037103085368 | 0.25 oz. Solder paste w/syringe applicator | 0.50 | 0.23 | 6 |
| K3B | 037103083159 | Three 4-1/2" Flux brushes, carded | 0.70 | 0.32 | 6 |

RC40

- 5 ft./1.52 m x .062 in./1.57 mm diameter
- 40/60 alloy
- Rosin core
- Ideal for electronics work
- Carded for point-of-purchase display
- Maximum surface 6-1/4 in./160 mm x 9-1/8 in./235 mm



| Cat. No. | UPC No. | Description | Shelf Pack Wt. | | Shelf Pack |
|----------|--------------|--------------------------|----------------|------|------------|
| | | | lb | kg | |
| RC40 | 037103473851 | Rosin-core solder-carded | 1.00 | 0.45 | 12 |
| AC40 | 037103473769 | Acid-core solder-carded | 1.00 | 0.45 | 12 |

RC60V

[查询"53002699"供应商](#)



- 13 ft./3.96 m x .040 in./1.02 mm diameter
- Active rosin core - lead free
- Ideal for electronics work
- Carded dispenser tube with hang-up eye for point-of-purchase display

| Cat. No. | UPC No. | Description | Shelf Pack Wt. | | Shelf Pack |
|----------|--------------|--------------------------|----------------|------|------------|
| | | | lb | kg | |
| RC60V | 037103013385 | Rosin-core solder-carded | 1.37 | 0.61 | 6 |

Solder spools and bars - 1 lb.



- Complete line of 60/40 and 63/37 solder
60/40 = 60% Tin/40% Lead
63/37 = 63% Tin/37% Lead
- Approved for commercial and military applications
- Conforms to specifications QQ-S-571 type WRMAP-3
- Melting point: 60/40 = 375°F; 63/37 = 361°F
- Tensile strength: 60/40 and 63/37 = 6400 PSI
- Shear strength: 60/40 and 63/37 = 5700 PSI
- Hardness: 60/40 and 63/37 = 16.0 BHN
- Available in 1 lb. spools and 1 lb. bars

| Cat. No. | UPC No. | Description | Shelf Pack Wt. | | Shelf Pack |
|----------|--------------|--------------------------------------|----------------|------|------------|
| | | | lb | kg | |
| WS6016 | 037103592507 | Solder, 60/40; .062" dia/16 ga/spool | 5.00 | 2.26 | 5 |
| WS6018 | 037103592491 | Solder, 60/40; .050" dia/18 ga/spool | 5.00 | 2.26 | 5 |
| WS6021 | 037103592484 | Solder, 60/40; .032" dia/21 ga/spool | 5.00 | 2.26 | 5 |
| WS6023 | 037103592477 | Solder, 60/40; .025" dia/23 ga/spool | 5.00 | 2.26 | 5 |
| WS6316 | 037103592543 | Solder, 63/37; .062" dia/16 ga/spool | 5.00 | 2.26 | 5 |
| WS6318 | 037103592446 | Solder, 63/37; .050" dia/18 ga/spool | 5.00 | 2.26 | 5 |
| WS6321 | 037103592521 | Solder, 63/37; .032" dia/21 ga/spool | 5.00 | 2.26 | 5 |
| WS6323 | 037103592514 | Solder, 63/37; .025" dia/23 ga/spool | 5.00 | 2.26 | 5 |
| WSB60 | 037103592460 | Solder, 60/40; bar | 5.00 | 2.26 | 5 |
| WSB63 | 037103592439 | Solder, 63/37; bar | 5.00 | 2.26 | 5 |

WPB1 polishing bar



- Used for cleaning soldering tips
- Removes plastic resins, oxidation, silicone grease and other chemicals from tip
- After cleaning tip, always re-tin immediately to prevent oxidation

| Cat. No. | UPC No. | Description | Shelf Pack Wt. | | Shelf Pack |
|----------|--------------|----------------------------------|----------------|------|------------|
| | | | lb | kg | |
| WPB1 | 037103590602 | Polishing bar for soldering tips | 0.25 | 0.11 | 1 |

Tips for electronic soldering stations Weller "Longlife" tips

[查询"53002699"供应商](#)

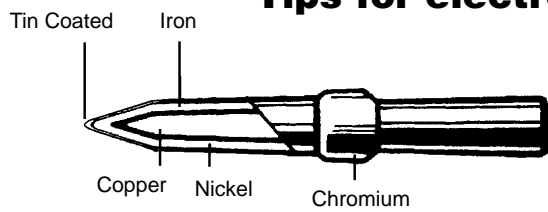

- A Weller "Longlife" tip is made of copper core which is electroplated with iron to extend the lifetime of the tip
- Tips are plated with iron, nickel and chromium, precision ground and provide maximum heat transfer from heater to tip
- The nickel and chromium protect the shank from corrosion and solder creep
- Tips are pre-tinned in the working area with solder. Keep tip tinned; wipe only before using
- Do not remove excess solder from heated tip before storing; the excess solder will prevent oxidation on the wettable surface when tip is reheated
- Use rosin or activated rosin fluxes. Acid type fluxes will greatly reduce tip life
- Tips in constant use should be removed and cleaned at least once a week
- If tip becomes unwettable, it may be cleaned hot with a Weller WPB1 polishing bar
- **IMPORTANT:** Use only Weller soldering tips. Use of non-Weller components may void product warranty if the non-Weller component causes damage to the unit

ET series tips for EC1201A, EC1201AFE irons

- Solid copper, plated with iron, nickel and chromium, precision ground ET series tips
- Provide maximum heat transfer from the heater to the tip
- Individually packaged and packed 10 per box
- * Available bulk packed (100 multiples only); 200 lot minimum order; greater discount offered on orders of 600 lots and above
- To order bulk, add suffix "B" to Cat. No. eg: ETA-B
- **IMPORTANT:** Use only Weller tips. Use of non-Weller components may void warranty if non-Weller component causes damage to the unit

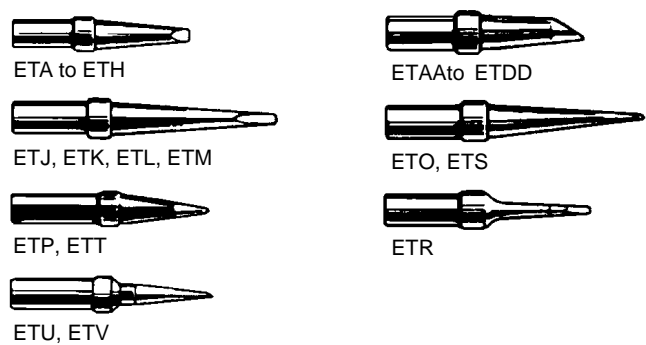

| Cat. No. | UPC No. | Description | Tip Size | | Reach | | Shelf Pk. Wt. | | Shelf Pack |
|----------|--------------|------------------------|----------|------|-------|-------|---------------|------|------------|
| | | | Inch | mm | Inch | mm | lb | kg | |
| ETA* | 037103477286 | Screwdriver tip | 0.062 | 1.60 | 0.625 | 15.90 | 0.37 | 0.16 | 10 |
| ETB* | 037103477279 | Screwdriver tip | 0.093 | 2.40 | 0.625 | 15.90 | 0.37 | 0.16 | 10 |
| ETC* | 037103477262 | Screwdriver tip | 0.125 | 3.20 | 0.625 | 15.90 | 0.37 | 0.16 | 10 |
| ETD* | 037103477255 | Screwdriver tip | 0.187 | 0.48 | 0.625 | 15.90 | 0.37 | 0.16 | 10 |
| ETH* | 037103477231 | Screwdriver tip | 0.031 | 0.80 | 0.625 | 15.90 | 0.37 | 0.16 | 10 |
| ETP* | 037103477248 | Conical tip | 0.031 | 0.80 | 0.625 | 15.90 | 0.37 | 0.16 | 10 |
| ETT | 037103591548 | Conical tip | 0.024 | 0.60 | 0.625 | 15.90 | 0.37 | 0.16 | 10 |
| ETU | 037103591760 | Single flat tip | 0.015 | 0.40 | 0.700 | 17.80 | 0.37 | 0.16 | 10 |
| ETV | 037103591524 | Single flat tip | 0.024 | 0.60 | 0.700 | 17.80 | 0.37 | 0.16 | 10 |
| ETAA | 037103591579 | Single flat tip | 0.062 | 1.60 | 0.625 | 15.90 | 0.37 | 0.16 | 10 |
| ETBB | 037103591562 | Single flat tip | 0.093 | 2.40 | 0.625 | 15.90 | 0.37 | 0.16 | 10 |
| ETCC | 037103478085 | Single flat tip | 0.125 | 3.20 | 0.625 | 15.90 | 0.37 | 0.16 | 10 |
| ETDD | 037103478092 | Single flat tip | 0.187 | 4.80 | 0.625 | 15.90 | 0.37 | 0.16 | 10 |
| ETO* | 037103477224 | Long conical tip | 0.031 | 0.80 | 1.000 | 25.40 | 0.37 | 0.16 | 10 |
| ETS* | 037103478054 | Long conical tip | 0.015 | 0.40 | 1.000 | 25.40 | 0.37 | 0.16 | 10 |
| ETJ | 037103591555 | Long screwdriver | 0.031 | 0.08 | 1.000 | 25.40 | 0.37 | 0.16 | 10 |
| ETK* | 037103477217 | Long screwdriver tip | 0.046 | 1.20 | 1.000 | 25.40 | 0.37 | 0.16 | 10 |
| ETL* | 037103477200 | Long screwdriver tip | 0.078 | 2.00 | 1.000 | 25.40 | 0.37 | 0.16 | 10 |
| ETM | 037103478108 | Long screwdriver tip | 0.125 | 3.20 | 1.000 | 25.40 | 0.37 | 0.16 | 10 |
| ETR | 037103478115 | Narrow screwdriver tip | 0.062 | 1.60 | 0.625 | 15.90 | 0.37 | 0.16 | 10 |

MT series tips for MT1500 series stations

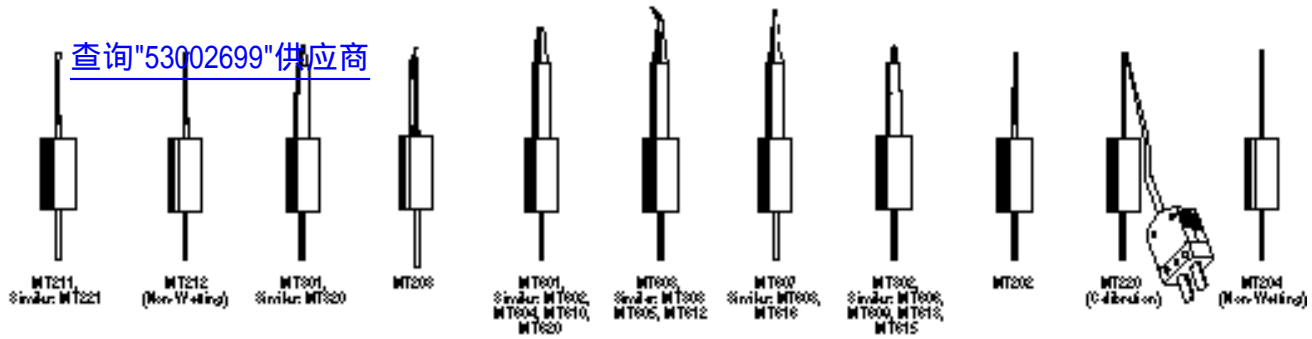

- Quick change plug-in tips are made from stainless steel
- Use only Weller soldering tips
- Heater and sensor located in tip

| Cat. No. | UPC No. | Type | Tip Size | | Reach | | Comment | Shelf Pack |
|----------|--------------|-------------------------|----------|------|-------|-------|-------------|------------|
| | | | Inch | mm | Inch | mm | | |
| MT202 | 037103101495 | Conical | 0.030 | 0.76 | 1.00 | 25.4 | - | 1 |
| MT203 | 037103101501 | Conical | 0.030 | 0.76 | 1.00 | 25.4 | MIL-SPEC | 1 |
| MT204 | 037103101488 | Conical | 0.030 | 0.76 | 1.00 | 25.4 | NON-WETTING | 1 |
| MT211 | 037103101457 | Screwdriver | 0.045 | 1.14 | 1.00 | 25.4 | - | 1 |
| MT212 | 037103101365 | Screwdriver | 0.045 | 1.14 | 1.00 | 25.4 | NON-WETTING | 1 |
| MT220 | 037103101099 | Calibration Conical | 0.030 | 0.76 | - | - | - | 1 |
| MT221 | 037103101433 | Micro | 0.031 | 0.79 | 1.00 | 25.4 | - | 1 |
| MT301 | 037103101907 | Screwdriver | 0.047 | 1.19 | 0.020 | 0.51 | - | 1 |
| MT302 | 037103101914 | Conical | 0.015 | 0.38 | 0.020 | 0.51 | - | 1 |
| MT303 | 037103101709 | Bent Conical | 0.015 | 0.38 | 0.32 | 8.13 | - | 1 |
| MT320 | 037103108890 | Calibration Screwdriver | 0.047 | 1.19 | 0.20 | 5.08 | - | 1 |
| MT601 | 037103097576 | Screwdriver | 0.070 | 1.78 | 0.385 | 9.78 | - | 1 |
| MT602 | 037103097583 | Screwdriver | 0.100 | 2.54 | 0.39 | 9.78 | - | 1 |
| MT603 | 037103097552 | Conical, Bent | 0.020 | 0.51 | 0.60 | 15.24 | - | 1 |
| MT604 | 037103097569 | Screwdriver | 0.060 | 1.52 | 0.39 | 9.91 | - | 1 |
| MT605 | 037103097538 | Bent Conical | 0.016 | 0.41 | 0.56 | 14.22 | - | 1 |
| MT606 | 037103097545 | Conical | 0.016 | 0.41 | 0.53 | 13.46 | - | 1 |
| MT607 | 037103097514 | Bevel | 0.020 | 0.51 | 0.53 | 13.5 | - | 1 |
| MT608 | 037103097538 | Bevel | 0.040 | 1.02 | 0.56 | 14.22 | - | 1 |
| MT609 | 037103097491 | Conical | 0.023 | 0.58 | 0.60 | 15.24 | - | 1 |
| MT610 | 037103097507 | Screwdriver | 0.200 | 5.08 | 0.35 | 8.89 | - | 1 |
| MT611 | 037103097477 | Chisel | 0.060 | 1.52 | 0.61 | 15.49 | - | 1 |
| MT612 | 037103097484 | Bent Conical | 0.050 | 1.27 | 0.88 | 22.35 | - | 1 |
| MT613 | 037103097453 | Conical | 0.020 | 0.51 | 0.52 | 13.21 | - | 1 |
| MT614 | 037103097460 | Chisel | 0.100 | 2.54 | 0.19 | 4.38 | - | 1 |
| MT615 | 037103097439 | Conical | 0.030 | 0.76 | 0.39 | 9.91 | - | 1 |
| MT616 | 037103097446 | Bevel | 0.032 | 0.81 | 0.56 | 14.22 | - | 1 |
| MT620 | 037103108968 | Bevel, 30 Degree | 0.063 | 1.59 | 0.385 | 9.78 | - | 1 |

Continued on next page.

MT series tips for MT1500 series stations - SMD applications

查询"53002699"供应商

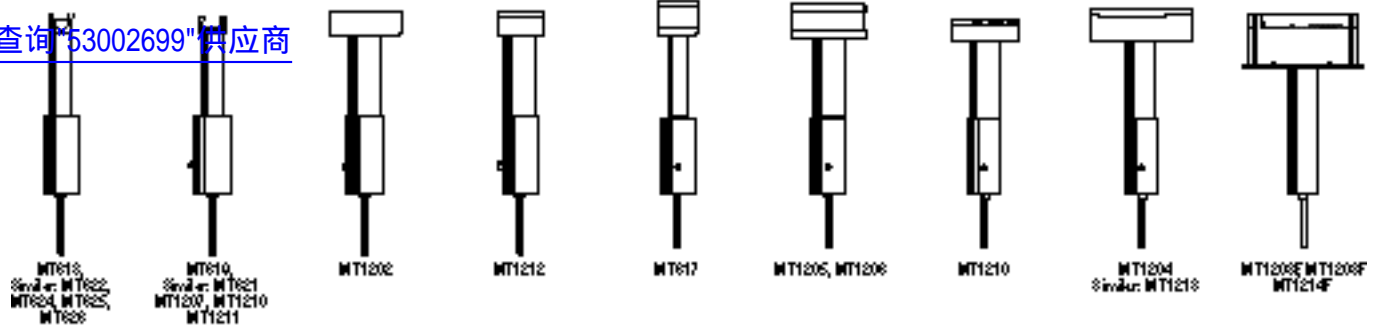

| Cat. No. | UPC No. | Type | Length in./mm | Width in./mm | Height in./mm | Shelf Pack |
|----------|--------------|------------------|---------------|--------------|---------------|------------|
| MT617 | 037103108906 | SMT Blade | 0.410/10.414 | 0.022/0.559 | 0.280/7.112 | 1 |
| MT618 | 037103109088 | Chip 1206, 1210 | 0.070/1.778 | 0.195/9.429 | 0.070/1.778 | 1 |
| MT619 | 037103109095 | SOIC 14.16 | 0.410/10.414 | 0.200/5.08 | 0.090/2.286 | 1 |
| MT621 | 037103108975 | SOIC 8 | 0.180/4.572 | 0.200/5.08 | 0.090/2.286 | 1 |
| MT622 | 037103108982 | Chip 0805 | 0.060/1.524 | 0.090/2.286 | 0.070/1.778 | 1 |
| MT623 | 037103108999 | SOMC 16 | 0.450/11.49 | 0.270/6.858 | 0.090/2.286 | 1 |
| MT624 | 037103109002 | SOT23 | 0.100/2.540 | 0.068/1.727 | 0.055/1.397 | 1 |
| MT625 | 037103109019 | Chip 1808/1812 | 0.090/2.286 | 0.190/4.528 | 0.070/1.778 | 1 |
| MT626 | 037103121905 | Quad PLCC 18 | 0.105/2.667 | 0.303/7.696 | 0.150/3.81 | 1 |
| MT627 | 037103122407 | - | - | - | - | 1 |
| MT1201 | 037103109026 | PLCC 28 | 0.500/12.700 | 0.500/12.700 | 0.150/3.81 | 1 |
| MT1202 | 037103109033 | PLCC 20 | 0.410/10.414 | 0.410/10.414 | 0.150/3.81 | 1 |
| MT1203F | 037103108913 | Flex Leg PLCC 44 | 0.750/19.050 | 0.750/19.050 | 2.35/5.959 | 1 |
| MT1204 | 037103109040 | PLCC 32 | 0.500/12.70 | 0.500/12.70 | 0.150/3.81 | 1 |
| MT1205 | 037103108920 | SMT Blade | 0.820/20.828 | 0.022/0.559 | 0.280/7.112 | 1 |
| MT1206 | 037103109057 | SMT Blade | 0.620/16.748 | 0.022/0.559 | 0.280/7.112 | 1 |
| MT1207 | 037103109064 | SOIC 20 | 0.520/13.208 | 0.375/9.525 | 0.125/3.176 | 1 |
| MT1208F | 037103108937 | Flex Leg PLCC 68 | 0.965/24.511 | 0.965/24.511 | 2.35/5.959 | 1 |
| MT1209 | 037103109071 | SOJ 28, SOM 36 | 0.740/18.796 | 0.365/9.017 | 0.125/3.175 | 1 |
| MT1210 | 037103121899 | SOIC 28 | 0.720/18.268 | 0.375/9.525 | 0.125/3.175 | 1 |
| MT1211 | 037103121912 | SOIC 24 | 0.620/15.748 | 0.375/9.525 | 0.125/3.175 | 1 |
| MT1212 | 037103121875 | PLCC 18 | 0.540/13.716 | 0.340/8.596 | 0.150/3.810 | 1 |
| MT1213 | 037103121868 | QFP 64-80 | 0.915/23.241 | 0.580/17.272 | 0.150/3.81 | 1 |
| MT1214F | 037103127754 | Flex Leg PLCC 84 | 1.155/29.591 | 1.165/29.591 | 0.235/5.969 | 1 |

EPH series tips for EC1302A iron

[查询"53002699"供应商](#)

- Solid copper, plated with iron, nickel and chromium, precision ground EPH series tips
- Provide maximum heat transfer from heater to tip
- **IMPORTANT:** Use only Weller soldering tips. Use of non-Weller components may void product warranty if the non-Weller component causes damage to the unit

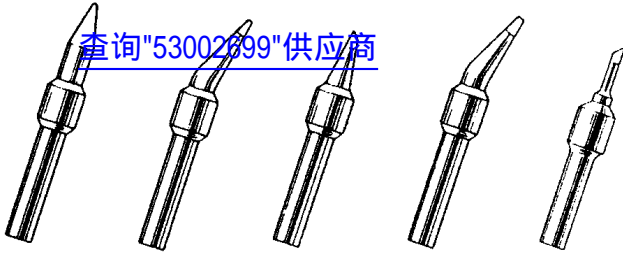

EPH101 EPH102 EPH103 EPH104 EPH105

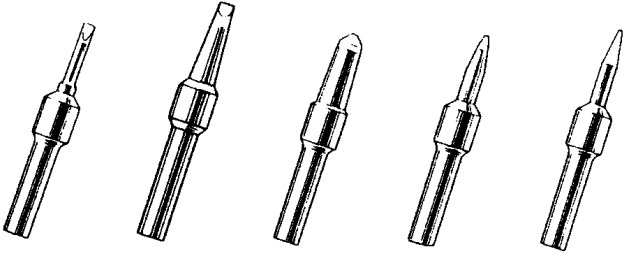

EPH106 EPH107 EPH108 EPH109 EPH110
EPH111

| Cat. No. | UPC No. | Description | Tip Size | | Reach | | Shelf Pk. Wt. | | Shelf Pack |
|----------|--------------|---------------------|----------|-------|-------|-------|---------------|------|------------|
| | | | Inch | mm | Inch | mm | lb | kg | |
| EPH101 | 037103479600 | Micropoint tip | 0.015 | 0.40 | 0.437 | 11.10 | 0.37 | 0.16 | 10 |
| EPH102 | 037103479617 | Bent conical tip | 0.031 | 0.80 | 0.437 | 11.10 | 0.37 | 0.16 | 10 |
| EPH104 | 037103479631 | Bent conical tip | 0.046 | 1.20 | 0.437 | 11.10 | 0.37 | 0.16 | 10 |
| EPH103 | 037103479624 | Single flat tip | 0.031 | 0.80 | 0.312 | 7.90 | 0.37 | 0.16 | 10 |
| EPH105 | 037103479648 | Single flat tip | 0.046 | 1.20 | 0.312 | 7.90 | 0.37 | 0.16 | 10 |
| EPH106 | 037103479655 | Screwdriver tip | 0.062 | 1.60 | 0.437 | 11.10 | 0.37 | 0.16 | 10 |
| EPH111 | 037103591531 | Screwdriver tip | 0.625 | 16.76 | 0.437 | 11.10 | 0.37 | 0.16 | 10 |
| EPH107 | 037103479662 | Chisel tip | 0.078 | 2.00 | 0.437 | 11.10 | 0.37 | 0.16 | 10 |
| EPH108 | 037103480231 | Chisel tip | 0.125 | 2.80 | 0.437 | 11.10 | 0.37 | 0.16 | 10 |
| EPH109 | 037103479679 | Conical tip | 0.031 | 0.80 | 0.437 | 11.10 | 0.37 | 0.16 | 10 |
| EPH110 | 037103474124 | Conical tip | 0.062 | 1.60 | 0.437 | 11.10 | 0.37 | 0.16 | 10 |
| EPH112 | 037103593320 | Long micropoint tip | 0.015 | 0.40 | 0.625 | 15.90 | 0.37 | 0.16 | 10 |

EM series tips for EC1503A

- Solid copper, plated with iron, nickel and chromium, www.weller.com EM series tips
 - Provide maximum heat transfer from heater to tip
 - Manufactured with patented** taper fit to match heater sheath
 - Provides maximum heat transfer from heater to tip
 - **IMPORTANT:** Use only Weller soldering tips. Use of non-Weller components may void product warranty if the non-Weller component causes damage to the unit
- ** Patent No. 4560101



EMA



EMF



EMB, EMM, EMN



EMG, EMJ



EMC



EMH



EMD



EMI, EMY



EME



EMX

| Cat. No. | UPC No. | Description | Tip Size | | Reach | | Shelf Pk. Wt. | | Shelf Pack |
|----------|--------------|------------------------|----------|------|-------|-------|---------------|------|------------|
| | | | Inch | mm | Inch | mm | lb | kg | |
| EMA | 037103591777 | Chisel tip | 0.062 | 1.60 | 0.42 | 10.66 | 0.37 | 0.16 | 10 |
| EMB | 037103591784 | Chisel tip | 0.093 | 2.40 | 0.42 | 10.66 | 0.37 | 0.16 | 10 |
| EMF | 037103592651 | Chisel tip | 0.046 | 1.20 | 0.52 | 13.20 | 0.37 | 0.16 | 10 |
| EMH | 037103591791 | Chisel tip | 0.031 | 0.80 | 0.42 | 10.66 | 0.37 | 0.16 | 10 |
| EMI | 037103000156 | Chisel tip | 0.203 | 5.23 | 0.42 | 10.66 | 0.37 | 0.16 | 10 |
| EMM | 037103104236 | Chisel tip, long reach | 0.125 | 3.30 | 0.31 | 7.87 | 0.37 | 0.16 | 10 |
| EMN | 037103104687 | Chisel tip | 0.125 | 3.30 | 0.31 | 7.87 | 0.37 | 0.16 | 10 |
| EMC | 037103592620 | Conical tip | 0.015 | 0.35 | 0.42 | 10.66 | 0.37 | 0.16 | 10 |
| EMD | 037103592637 | Conical tip | 0.015 | 0.35 | 0.61 | 15.49 | 0.37 | 0.16 | 10 |
| EME | 037103592644 | Conical tip | 0.031 | 0.81 | 0.65 | 16.51 | 0.37 | 0.16 | 10 |
| EMG | 037103592668 | Bent conical tip | 0.015 | 0.35 | 0.45 | 11.43 | 0.37 | 0.16 | 10 |
| EMJ | 037103592866 | Bent conical tip | 0.046 | 1.06 | 1.03 | 26.16 | 0.37 | 0.16 | 10 |
| EMY | 037103591814 | Blunt chisel tip | 0.125 | 3.30 | 0.42 | 10.66 | 0.37 | 0.16 | 10 |
| EMX | 037103591807 | Blunt chisel tip | 0.062 | 1.60 | 0.42 | 10.66 | 0.37 | 0.16 | 10 |

PT series tips for TC201T iron

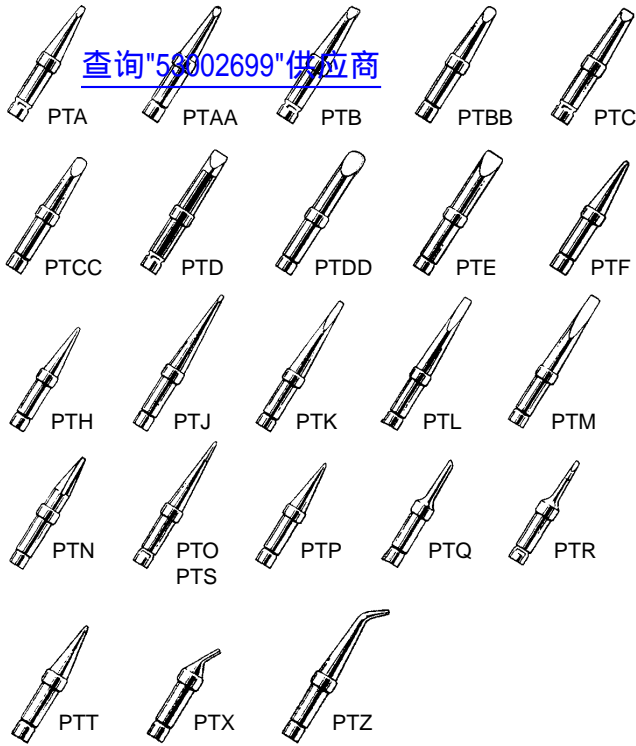

[查询"58002699"供应商](#)

- Heavy iron plated, precision ground PT series tips
- Provide maximum heat transfer from heater to tip
- * Available bulk packed (100 multiples only); 200 lot minimum order quantity; greater discount offered on orders of 600 lots and above
- To order bulk, add suffix "B" to Cat. No. eg: PTA7-B
- **IMPORTANT:** Use only Weller soldering tips. Use of non-Weller components may void product warranty if the non-Weller component causes damage to the unit
- Individually carded and packed 10 per box

| 600°F (315°C) | | 700°F (371°C) | | 800°F (427°C) | | Description | Tip size | | Reach | | Shelf | | Shelf Pack |
|---------------|-----------------------|---------------|-----------------------|---------------|-----------------------|--------------------|-------------|-------|-------|-------|-------------|------|------------|
| Cat. No. | UPC No. 037103 | Cat. No. | UPC No. 037103 | Cat. No. | UPC No. 037103 | | Inch | mm | Inch | mm | Pack Wt. lb | kg | |
| PTA6 | 473011 | PTA7* | 473226 | PTA8* | 473417 | | Screwdriver | 0.062 | 1.57 | 0.62 | 15.87 | 0.37 | |
| PTAA6 | 473028 | PTAA7* | 473233 | PTAA8* | 473424 | Single flat | 0.062 | 1.57 | 0.62 | 15.87 | 0.37 | 0.16 | 10 |
| PTB6 | 473035 | PTB7* | 473240 | PTB8* | 473431 | Screwdriver | 0.093 | 2.38 | 0.62 | 15.87 | 0.37 | 0.16 | 10 |
| PTBB6 | 473042 | PTBB7* | 473257 | PTBB8 | 473448 | Single flat | 0.093 | 2.38 | 0.62 | 15.87 | 0.37 | 0.16 | 10 |
| PTC6 | 473059 | PTC7* | 473264 | PTC8* | 473455 | Screwdriver | 0.125 | 3.17 | 0.62 | 15.87 | 0.37 | 0.16 | 10 |
| PTCC6 | 473066 | PTCC7 | 473271 | PTCC8 | 473462 | Single flat | 0.125 | 3.17 | 0.62 | 15.87 | 0.37 | 0.16 | 10 |
| PTD6 | 473073 | PTD7* | 473288 | PTD8* | 473479 | Screwdriver | 0.187 | 4.74 | 0.62 | 15.87 | 0.37 | 0.16 | 10 |
| PTDD6 | 473080 | PTDD7 | 473295 | PTDD8 | 473486 | Single flat | 0.187 | 4.74 | 0.62 | 15.87 | 0.37 | 0.16 | 10 |
| PTE6 | 473097 | PTE7* | 473301 | PTE8* | 473493 | Screwdriver | 0.234 | 5.95 | 0.62 | 15.87 | 0.37 | 0.16 | 10 |
| PTF6 | 473103 | PTF7* | 473338 | PTF8* | 473509 | Conical flat | 0.031 | 0.79 | 0.62 | 15.87 | 0.37 | 0.16 | 10 |
| PTH6 | 473110 | PTH7* | 473325 | PTH8* | 473516 | Screwdriver | 0.031 | 0.79 | 0.62 | 15.87 | 0.37 | 0.16 | 10 |
| PTJ6 | 591630 | PTJ7 | 591623 | PTJ8 | 591616 | Screwdriver | 0.015 | 0.39 | 1.00 | 25.40 | 0.37 | 0.16 | 10 |
| PTK6 | 473127 | PTK7* | 473332 | PTK8* | 473523 | Long screwdriver | 0.046 | 1.19 | 1.00 | 25.40 | 0.37 | 0.16 | 10 |
| PTL6 | 473134 | PTL7* | 473349 | PTL8* | 473530 | Long screwdriver | 0.078 | 1.98 | 1.00 | 25.40 | 0.37 | 0.16 | 10 |
| PTM6 | 473141 | PTM7* | 473356 | PTM8* | 473547 | Long screwdriver | 0.125 | 3.17 | 1.00 | 25.40 | 0.37 | 0.16 | 10 |
| PTN6 | 591753 | PTN7 | 591746 | PTN8 | 591739 | Screwdriver | 0.062 | 1.58 | 0.75 | 19.05 | 0.37 | 0.16 | 10 |
| PTO6 | 473158 | PTO7* | 473363 | PTO8* | 473561 | Long conical | 0.031 | 0.79 | 1.00 | 25.40 | 0.37 | 0.16 | 10 |
| PTP6 | 473165 | PTP7* | 473370 | PTP8* | 473554 | Conical | 0.031 | 0.79 | 0.62 | 15.87 | 0.37 | 0.16 | 10 |
| PTQ6 | 591692 | PTQ7 | 591685 | PTQ8 | 591678 | Single flat | 0.031 | 0.79 | 0.62 | 15.87 | 0.37 | 0.16 | 10 |
| PTR6 | 473172 | PTR7* | 473387 | PTR8* | 473585 | Narrow screwdriver | 0.062 | 1.58 | 0.62 | 15.87 | 0.37 | 0.16 | 10 |
| PTS6 | 478023 | PTS7* | 478030 | PTS8* | 478047 | Long conical | 0.015 | 0.39 | 1.00 | 25.40 | 0.37 | 0.16 | 10 |
| PTT6 | 591661 | PTT7 | 591654 | PTT8 | 591654 | Conical | 0.025 | 0.63 | 0.62 | 15.87 | 0.37 | 0.16 | 10 |
| PTX6 | 591609 | PTX7 | 591593 | PTX8 | 591586 | Bent, slotted | 0.031 | 0.79 | 0.37 | 9.40 | 0.37 | 0.16 | 10 |
| PTZ6 | 591722 | PTZ7 | 591715 | PTZ8 | 591708 | Bent, slotted | 0.020 | 0.50 | 1.00 | 25.40 | 0.37 | 0.16 | 10 |

Tips for controlled output soldering irons CT series tips for W60P and W100PG irons

Solid copper, plated with iron, nickel and chromium, precision ground CT series tips

- Provide maximum heat transfer from heater to tip
- Individually carded; tips for W60P iron packed 10 per box; tips for W100PG packed 6 per box
- * Available bulk packed (100 multiples only); 200 lot minimum order quantity; greater discount offered on orders of 600 lots and above
- To order bulk, add suffix "B" to Cat. No. eg: CT6E7-B
- **IMPORTANT:** Use only Weller soldering tips. Use of non-Weller components may void product warranty if the non-Weller component causes damage to the unit

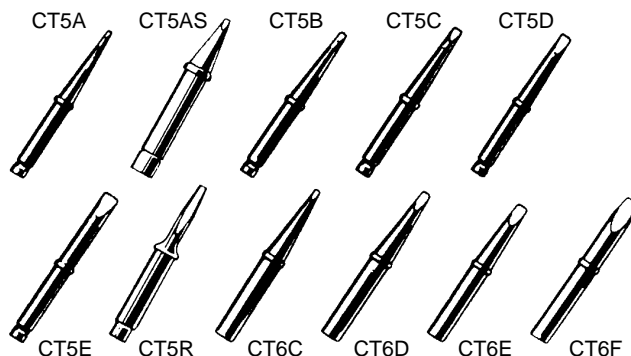

| 600°F (315°C) | | 700°F (371°C) | | 800°F (427°C) | | Description | Tip size | | Reach | | Shelf Pack Wt. | | Shelf Pack |
|---------------|---------------|---------------|---------------|---------------|---------------|------------------------|----------|------|-------|-------|----------------|------|------------|
| Cat. No. | UPC No. | Cat. No. | UPC No. | Cat. No. | UPC No. | | Inch | mm | Inch | mm | lb | kg | |
| | 037103 | | 037103 | | 037103 | | | | | | | | |
| CT5A6 | 472618 | CT5A7 | 472625 | CT5A8 | 472632 | W60P Screwdriver tip | 0.062 | 1.58 | 1.15 | 29.36 | 0.43 | 0.19 | 10 |
| CT5AS6 | 591487 | CT5AS7 | 591470 | CT5AS8 | 591463 | W60P Screwdriver tip | 0.062 | 1.58 | 0.62 | 15.87 | 0.37 | 0.16 | 10 |
| CT5B6 | 472649 | CT5B7 | 472656 | CT5B8 | 472656 | W60P Screwdriver tip | 0.093 | 2.38 | 1.15 | 29.36 | 0.43 | 0.19 | 10 |
| CT5C6 | 472670 | CT5C7 | 472687 | CT5C8 | 472694 | W60P Screwdriver tip | 0.125 | 3.17 | 1.15 | 29.36 | 0.43 | 0.19 | 10 |
| CT5D6 | 472717 | CT5D7 | 472724 | CT5D8 | 472731 | W60P Screwdriver tip | 0.187 | 4.74 | 1.15 | 29.36 | 0.43 | 0.19 | 10 |
| CT5E6 | 472748 | CT5E7 | 472755 | CT5E8 | 472762 | W60P Screwdriver tip | 0.250 | 6.35 | 1.15 | 29.36 | 0.43 | 0.19 | 10 |
| CT5R6 | 591517 | CT5R7 | 591517 | CT5R8 | 591494 | W60P Screwdriver tip | 0.062 | 1.58 | 0.87 | 22.22 | 0.43 | 0.19 | 10 |
| CT6C6 | 472847 | CT6C7 | 472854 | CT6C8 | 472861 | W100PG Screwdriver tip | 0.125 | 3.17 | 1.37 | 34.92 | 0.37 | 0.16 | 6 |
| CT6D6 | 472878 | CT6D7 | 472885 | CT6D8 | 472892 | W100PG Screwdriver tip | 0.187 | 4.74 | 1.37 | 34.92 | 0.43 | 0.19 | 6 |
| CT6E6 | 472908 | CT6E7* | 472915 | CT6E8 | 472922 | W100PG Screwdriver tip | 0.250 | 6.35 | 1.37 | 34.92 | 0.50 | 0.22 | 6 |
| CT6F6 | 472939 | CT6F7* | 472946 | CT6F8 | 472953 | W100PG Screwdriver tip | 0.375 | 9.52 | 1.37 | 34.92 | 0.50 | 0.22 | 6 |

Tips for professional soldering irons ST series tips for WP25, WP30, WP35 irons

- Solid copper, plated with iron, nickel and chromium, precision ground ST series tips
- Provide maximum heat transfer from heater to tip
- Individually carded and packed 10 per box
- Also available bulk packed (100 multiples only); add suffix "B" to Cat. No. eg ST1-B
- **IMPORTANT:** Use only Weller soldering tips. Use of non-Weller components may void product warranty if the non-Weller component causes damage to the unit

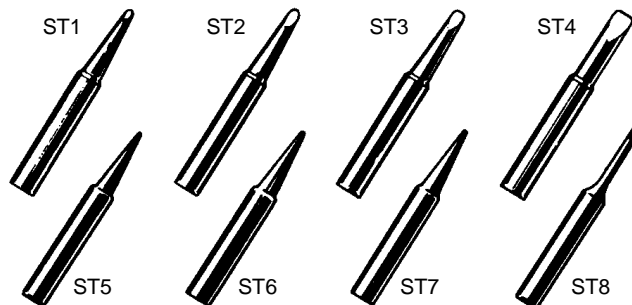

| Cat. No. | UPC No. | Description | Tip Size | | Reach | | Shelf Pk. Wt. | | Shelf Pack |
|----------|--------------|-----------------|----------|------|-------|-------|---------------|------|------------|
| | | | Inch | mm | Inch | mm | lb | kg | |
| ST1 | 037103472212 | Screwdriver tip | 0.062 | 1.58 | 0.75 | 19.05 | 0.25 | 0.11 | 10 |
| ST2 | 037103472434 | Screwdriver tip | 0.093 | 2.38 | 0.75 | 19.05 | 0.25 | 0.11 | 10 |
| ST3 | 037103472519 | Screwdriver tip | 0.125 | 3.17 | 0.75 | 19.05 | 0.25 | 0.11 | 10 |
| ST4 | 037103472601 | Screwdriver tip | 0.187 | 4.74 | 0.75 | 19.05 | 0.25 | 0.11 | 10 |
| ST5 | 037103472809 | Single flat tip | 0.031 | 0.79 | 0.75 | 19.05 | 0.25 | 0.11 | 10 |
| ST6 | 037103473189 | Screwdriver tip | 0.031 | 0.79 | 0.75 | 19.05 | 0.25 | 0.11 | 10 |
| ST7 | 037103473394 | Conical tip | 0.031 | 0.79 | 0.75 | 19.05 | 0.25 | 0.11 | 10 |
| ST8 | 037103473578 | Narrow SD tip | 0.062 | 1.58 | 0.75 | 19.05 | 0.25 | 0.11 | 10 |

WT series tips for ProPlus™ series irons

[查询"53002699"供应商](#)

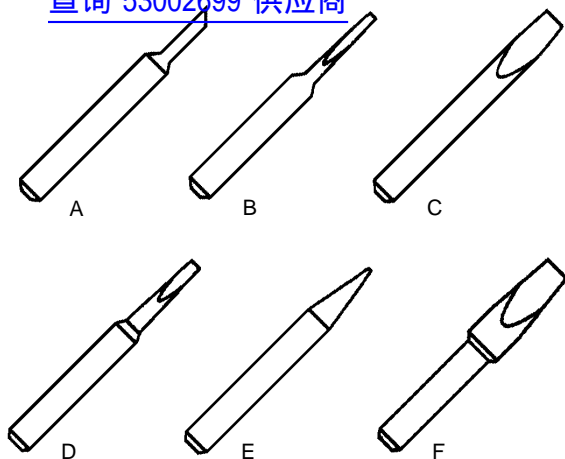

- Wide selection of tips in different sizes and styles
- Long-lasting iron plated - easy to replace
- IMPORTANT: Use only Weller soldering tips. Use of non-Weller components may void product warranty if the non-Weller component causes damage to the unit

For WP40S, WP60S, WP60H soldering irons

| Cat. No. | UPC No. | Description | Tip Size | | Reach | | Tip Style | Shelf Pk. Wt. | | Shelf Pack |
|----------|--------------|-----------------|----------|------|-------|-------|-----------|---------------|------|------------|
| | | | Inch | mm | Inch | mm | | lb | kg | |
| WT159 | 037103081193 | 30° Flat tip | .062 | 1.59 | .062 | 1.59 | A | 0.27 | 0.12 | 10 |
| WT313 | 037103081209 | Screwdriver tip | .187 | 4.76 | .187 | 4.76 | C | 0.31 | 0.14 | 10 |
| WT324 | 037103081216 | Screwdriver tip | .125 | 3.18 | .125 | 3.18 | B | 0.20 | 0.09 | 10 |
| WT358 | 037103081223 | Screwdriver tip | .093 | 2.38 | .375 | 9.53 | D | 0.20 | 0.09 | 10 |
| WT397 | 037103081230 | Screwdriver tip | .156 | 3.97 | .750 | 19.05 | C | 0.30 | 0.14 | 10 |
| WT399 | 037103081247 | Screwdriver tip | .218 | 5.56 | .375 | 9.53 | C | 0.30 | 0.14 | 10 |
| WT417 | 037103081254 | Screwdriver tip | .125 | 3.18 | .750 | 19.05 | C | 0.30 | 0.14 | 10 |
| WT451 | 037103081261 | Screwdriver tip | .125 | 3.18 | .500 | 12.70 | B | 0.20 | 0.09 | 10 |
| WT463 | 037103081278 | Screwdriver tip | .187 | 4.76 | .562 | 14.29 | B | 0.28 | 0.13 | 10 |
| WT513 | 037103081285 | Conical tip | .125 | 3.18 | .500 | 12.70 | E | 0.20 | 0.09 | 10 |
| WT552 | 037103081292 | Screwdriver tip | .187 | 4.76 | .625 | 15.88 | F | 0.40 | 0.18 | 10 |
| WT586 | 037103081308 | Screwdriver tip | .125 | 3.18 | .500 | 12.70 | C | 0.20 | 0.09 | 10 |
| WT691 | 037103081315 | Screwdriver tip | .062 | 1.59 | .093 | 2.38 | B | 0.29 | 0.13 | 10 |
| WT699 | 037103081322 | Screwdriver tip | .062 | 1.59 | .500 | 12.70 | B | 0.25 | 0.11 | 10 |
| WT343 | 037103081339 | Conical tip | .031 | 0.79 | .625 | 15.88 | E | 0.20 | 0.09 | 10 |
| WT773 | 037103081346 | Screwdriver tip | .187 | 4.76 | .625 | 15.88 | F | 0.40 | 0.18 | 10 |

For WP100S soldering iron

| Cat. No. | UPC No. | Description | Tip Size | | Reach | | Tip Style | Shelf Pk. Wt. | | Shelf Pack |
|----------|--------------|------------------------|----------|----------|-------|-------|-----------|---------------|------|------------|
| | | | Inch | mm | Inch | mm | | lb | kg | |
| WT430 | 037103091369 | Round flat tip | .375x45° | 9.53x45° | - | - | A | 1.00 | 0.45 | 10 |
| WT470 | 037103091376 | Wide screwdriver tip | .312 | 7.94 | 1.187 | 30.16 | C | 0.50 | 0.23 | 10 |
| WT151 | 037103091345 | Chisel tip | .375 | 9.53 | 1.00 | 25.4 | C | 1.00 | 0.45 | 10 |
| WT108 | 037103091352 | Conical tip | .062 | 1.59 | .875 | 22.23 | E | 1.00 | 0.45 | 10 |
| WT140 | 037103091338 | Narrow screwdriver tip | .187 | 4.76 | 1.125 | 28.58 | D | 1.00 | 0.45 | 10 |

MP series tips for WM120 iron

- Solid copper, plated with iron, nickel and chromium, precision ground MP series tips
[查询"53002699"供应商](#)
 Provide maximum heat transfer from heater to tip
- Individually carded and packed 10 per box
- **IMPORTANT:** Use only Weller soldering tips. Use of non-Weller components may void product warranty if the non-Weller component causes damage to the unit

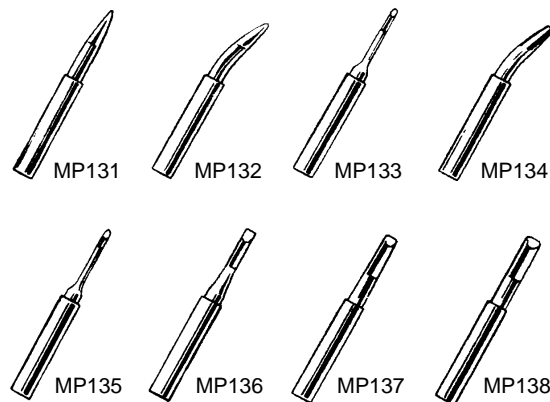

| Cat. No. | UPC No. | Description | Tip Size | | Reach | | Shelf Pk. Wt. | | Shelf Pack |
|----------|--------------|------------------------|----------|------|-------|-------|---------------|------|------------|
| | | | Inch | mm | Inch | mm | lb | kg | |
| MP131 | 037103474544 | Conical tip | 0.015 | 0.39 | 0.43 | 11.09 | 0.25 | 0.11 | 10 |
| MP132 | 037103474575 | Bent conical tip | 0.031 | 0.79 | 0.43 | 11.09 | 0.25 | 0.11 | 10 |
| MP133 | 037103474582 | Single flat 40° tip | 0.031 | 0.79 | 0.43 | 11.09 | 0.25 | 0.11 | 10 |
| MP134 | 037103474599 | Bent conical tip | 0.046 | 1.19 | 0.43 | 11.09 | 0.25 | 0.11 | 10 |
| MP135 | 037103474605 | Single flat 40° tip | 0.046 | 1.19 | 0.43 | 11.09 | 0.25 | 0.11 | 10 |
| MP136 | 037103474612 | Narrow screwdriver tip | 0.062 | 1.58 | 0.43 | 11.09 | 0.25 | 0.11 | 10 |
| MP137 | 03710347462 | Screwdriver tip | 0.078 | 1.98 | 0.43 | 11.09 | 0.25 | 0.11 | 10 |
| MP138 | 037103474636 | Chisel tip | 0.109 | 2.77 | 0.43 | 11.09 | 0.25 | 0.11 | 10 |

MPT series tips for MPR30 iron

- MPT series
- Micro-precision soldering tips for the most sophisticated of micro-soldering tasks
- **IMPORTANT:** Use only Weller soldering tips. Use of non-Weller components may void product warranty if the non-Weller component causes damage to the unit

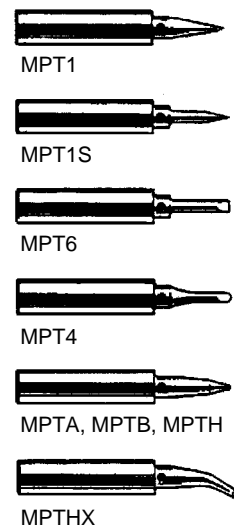

| Cat. No. | UPC No. | Description | Tip Size | | Reach | | Shelf Pk. Wt. | | Shelf Pack |
|----------|--------------|---------------|----------|------|-------|-------|---------------|------|------------|
| | | | Inch | mm | Inch | mm | lb | kg | |
| MPT1 | 037103046024 | Needle tip | 0.013 | 0.25 | 0.75 | 19.05 | 0.25 | 0.11 | 10 |
| MPT1S | 037103045980 | Needle tip | 0.013 | 0.25 | 0.75 | 19.05 | 0.25 | 0.11 | 10 |
| MPT6 | 037103045997 | Chisel tip | 0.062 | 1.60 | 0.75 | 19.05 | 0.25 | 0.11 | 10 |
| MPT4 | 037103046031 | Round tip | 0.046 | 1.20 | 0.75 | 19.05 | 0.25 | 0.11 | 10 |
| MPTB | 037103046017 | Flat tip | 0.093 | 2.41 | 0.75 | 19.05 | 0.25 | 0.11 | 10 |
| MPTA | 037103045966 | Flat tip | 0.062 | 1.60 | 0.75 | 19.05 | 0.25 | 0.11 | 10 |
| MPTH | 037103046000 | Flat tip | 0.031 | 0.80 | 0.75 | 19.05 | 0.25 | 0.11 | 10 |
| MPTHX | 037103045973 | Flat tip bent | 0.031 | 0.80 | 0.75 | 19.05 | 0.25 | 0.11 | 10 |

Tips for surface mount products

SMT series tips and adapters

Configurations

[查询"53002699"供应商](#)

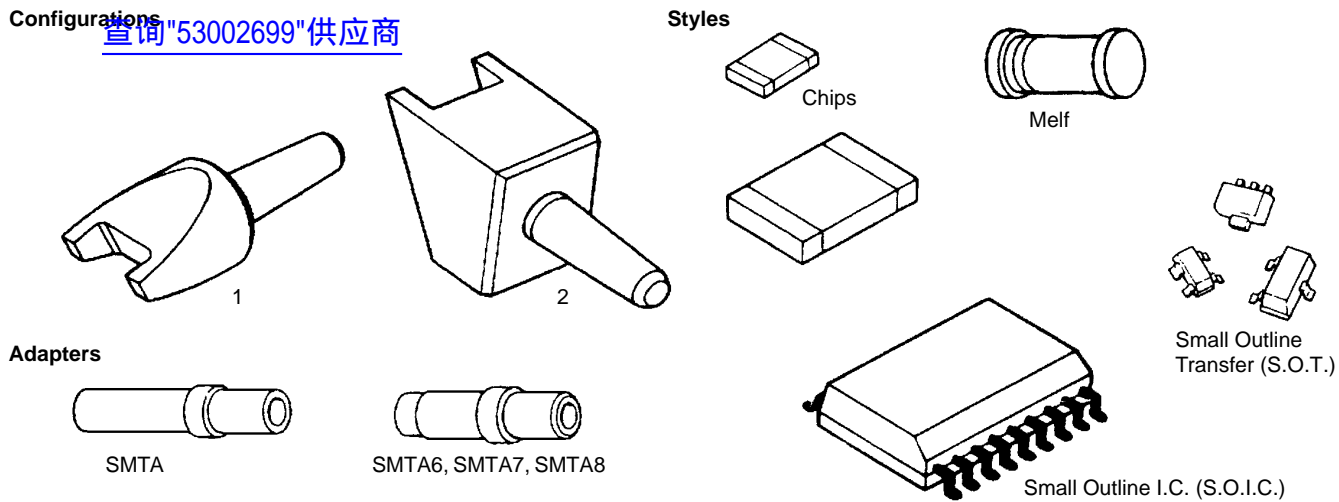

- Helpful, effective soldering tips make quick work of repairing surface mount assemblies using chip resistor/capacitors, and small outline devices

- Unique adapter system allows tip use in SMT applications with current Weller stations

| Cat. No. | UPC No. | Configuration Style | Design | Component Size (Nominal) | | | | Shelf Pack |
|----------|--------------|---|----------|--------------------------|------|--------|--------|------------|
| | | | | L | x W | x H | | |
| SMT0504A | 037103590909 | 1 | Chips | 0405 | .040 | x .050 | x .040 | 1 |
| | | 1 | Chips | 0504 | .050 | x .040 | x .040 | 1 |
| | | 1 | Chips | 0505 | .050 | x .050 | x .040 | 1 |
| SMT0805B | 037103590916 | 1 | Chips | 0705 | .070 | x .050 | x .040 | 1 |
| | | 1 | Chips | 0805 | .080 | x .050 | x .050 | 1 |
| SMT1005C | 037103590985 | 1 | Chips | 1005 | .100 | x .050 | x .050 | 1 |
| SMT1206D | 037103590923 | 1 | Chips | 1206 | .120 | x .060 | x .060 | 1 |
| | | 1 | Chips | 1210 | .120 | x .100 | x .065 | 1 |
| SMT1505E | 037103590992 | 1 | Chips | 1505 | .150 | x .050 | x .065 | 1 |
| SMT1808F | 037103590930 | 1 | Chips | 1805 | .180 | x .050 | x .065 | 1 |
| | | 1 | Chips | 1808 | .180 | x .080 | x .065 | 1 |
| | | 1 | Chips | 1812 | .180 | x .120 | x .065 | 1 |
| SMT1825G | 037103591005 | 1 | Chips | 1825 | .180 | x .250 | x .065 | 1 |
| SMT80H | 037103590947 | 1 | MELF | SOD80 | .138 | x .063 | Dia. | 1 |
| | | 1 | MELF | SOD87 | .138 | x .081 | Dia. | 1 |
| SMT23I | 037103590954 | 1 | S.O.T. | SOT23 | .118 | x .098 | x .043 | 1 |
| | | 1 | S.O.T. | SOT143 | .118 | x .098 | x .043 | 1 |
| SMT89J | 037103591012 | 1 | S.O.T. | SOT89 | .181 | x .167 | x .063 | 1 |
| SMT8K | 037103591029 | 2 | S.O.I.C. | SO8 | .197 | x .157 | x .066 | 1 |
| SMT14L | 037103591036 | 2 | S.O.I.C. | SO14 | .344 | x .157 | x .066 | 1 |
| SMT16L | 037103095503 | 2 | S.O.I.C. | SO16 | - | - | - | 1 |
| SMTA | 037103590978 | Tip adapter for EC1201 series iron | | | | | | 1 |
| SMTA6 | 037103591043 | 600°F tip adapter for TC201 series iron | | | | | | 1 |
| SMTA7 | 037103590961 | 700°F tip adapter for TC201 series iron | | | | | | 1 |
| SMTA8 | 037103591050 | 800°F tip adapter for TC201 series iron | | | | | | 1 |
| SMTAEM | 037103592774 | Tip adapter for EC1503 series iron | | | | | | 1 |

Hot air nozzles for WHA700 & WHA 2000

[查询"53002699"供应商](#)

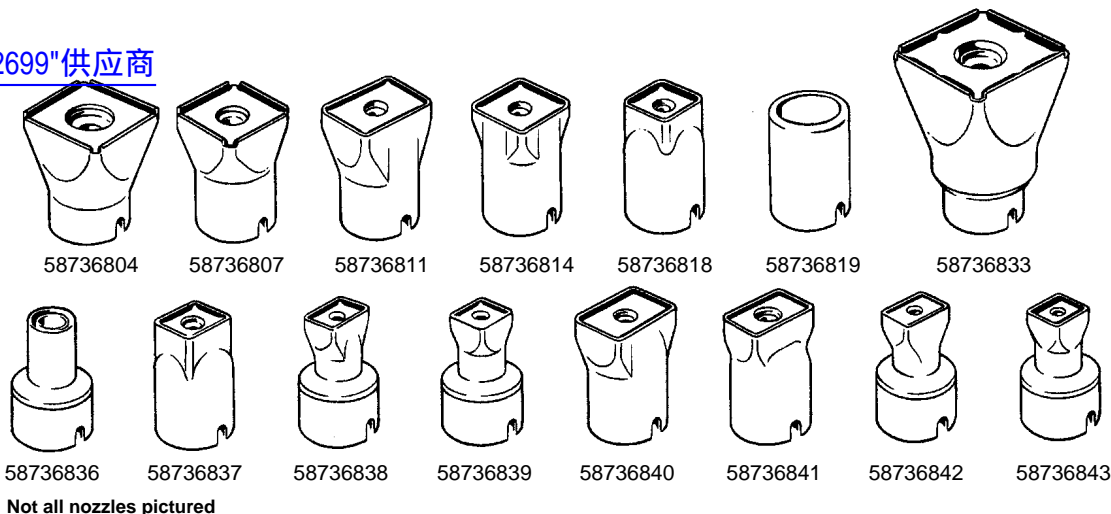

Not all nozzles pictured

| Cat. No. | UPC No. | Description | Fig. No. | Size | | Shelf Pack |
|--------------------------|--------------|--|-------------|-------------|---------------|------------|
| | | | | mm | in. | |
| 58736818 | 037103045058 | Hot air nozzle | | 14.1 x 14.1 | 0.555 x 0.555 | 1 |
| 58736814 | 037103045027 | Hot air nozzle | | 17.7 x 17.7 | 0.697 x 0.697 | 1 |
| 58736811 | 037103045034 | Hot air nozzle | | 17 x 23 | 0.906 x 0.906 | 1 |
| 58736807 | 037103045003 | Hot air nozzle | | 20.4 x 20.4 | 0.803 x 0.803 | 1 |
| 58736839 | 037103060884 | Hot air nozzle | | 11 x 11 | 0.433 x 0.433 | 1 |
| 58736838 | 037103060914 | Hot air nozzle | | 14.5 x 10 | 0.571 x 0.394 | 1 |
| 58736837 | 037103060907 | Hot air nozzle | | 15.5 x 13 | 0.610 x 0.512 | 1 |
| 58736804 | 037103045010 | Hot air nozzle | | 25.3 x 25.3 | 0.997 x 0.997 | 1 |
| 58736843 | 037103062673 | Hot air nozzle | | 10 x 8 | 0.394 x 0.315 | 1 |
| 58736842 | 037103060877 | Hot air nozzle | | 14 x 10 | 0.551 x 0.394 | 1 |
| 58736841 | 037103060860 | Hot air nozzle | | 19 x 12 | 0.748 x 0.472 | 1 |
| 58736840 | 037103060891 | Hot air nozzle | | 21.5 x 14 | 0.846 x 0.551 | 1 |
| 58736819 | 037103045065 | Nozzle adapter | | 21 dia. | 0.825 Dia. | 1 |
| 58736833 | 037103060853 | Hot air nozzle | | 32 x 32 | 1.26 x 1.26 | 1 |
| 58736836 | 037103060822 | Hot air nozzle | | 11.5 dia. | 0.453 Dia. | 1 |
| 58736857 | 037103089359 | Hot air nozzle | | 38.0 x 38.0 | 1.497 x 1.497 | 1 |
| 58736858 | 037103105455 | Hot air nozzle | SK0417 | 44.0 x 32.0 | 1.732 x 1.260 | 1 |
| 58736867 | 037103105479 | Hot air nozzle | NR050 | 4.0 Dia. | 0.157 Dia. | 1 |
| 58736870 | 037103105486 | Hot air nozzle | NR10 | 7.0 Dia. | 0.276 Dia. | 1 |
| 58736873 | 037103105462 | Hot air nozzle | SK0490 | 40.0 x 40.0 | 1.575 x 1.575 | 1 |
| 58736875 | 037103105431 | Hot air nozzle | NA20 | - | - | 1 |
| △ 58736876 | 037103132635 | Hot air nozzle | SK509/A | 27.0 x 12.0 | 1.064 x .473 | 1 |
| △ 58736877 | 037103132611 | Hot air nozzle | SK509/B | 29.0 x 17.0 | 1.143 x .670 | 1 |
| △ 58736880 | 037103132604 | Hot air nozzle | SK460/A | 24.0 x 12.0 | .946 x .473 | 1 |
| 58736881 | 037103104267 | Hot air nozzle | SINGLE | 2.5 Dia. | 0.098 Dia. | 1 |
| 58736882 | 037103104274 | Hot air nozzle | 40 DEG BENT | 3.0 x 1.5 | 0.118 x 0.059 | 1 |
| 58736883 | 037103104281 | Hot air nozzle | DUAL SINGLE | 2.5 | 0.098 | 1 |
| △ 58736890 | 037103132598 | Hot air nozzle | SK568 | 43.0 x 43.0 | 1.694 x 1.694 | 1 |
| △ 58736891 | 037103132581 | Hot air nozzle | SK572 | 36.0 x 36.0 | 1.418 x 1.418 | 1 |
| △ 58736892 | 037103132574 | Hot air nozzle | SK0578 | 27.0 x 14.0 | 1.064 x .552 | 1 |
| Replacement parts | | | | | | |
| W58713798 | 037103590268 | CSF rubber insert - 10 per bag - small 3mm | | | | 1 bag |
| W58713799 | 037103590275 | CSF rubber insert - 10 per bag - large 6mm | | | | 1 bag |

△ Made to order, contact customer service for delivery.

Hot air nozzles for WRS systems (for HAP1 hot air pencil)

| Cat. No. | UPC | Description | Fig. No. | Size | | Shelf Pack |
|----------|--------------|----------------|----------|-----------|-------------|------------|
| | | | | mm | in. | |
| 58727059 | 037103592811 | Hot air nozzle | - | 1.2 Dia. | 0.047 Dia. | 1 |
| 58727060 | 037103592804 | Hot air nozzle | - | 3.0 Dia. | 0.118 Dia. | 1 |
| 58727116 | 037103105301 | Hot air nozzle | R02 | 0.8 Dia. | 0.032 Dia. | 1 |
| 58727772 | 037103105257 | Hot air nozzle | F06 | 12.0x1.5 | 0.472x0.059 | 1 |
| 58727773 | 037103105264 | Hot air nozzle | F04 | 10.0x1.5 | 0.394x0.059 | 1 |
| 58727774 | 037103105271 | Hot air nozzle | F02 | 8.0x1.5 | 0.315x0.059 | 1 |
| 58727775 | 037103105318 | Hot air nozzle | FD4 | 10.0x1.5 | 0.394x0.059 | 1 |
| 58727776 | 037103105325 | Hot air nozzle | FD2 | 8.0x1.5 | 0.315x0.059 | 1 |
| 58727777 | 037103105776 | Hot air nozzle | Q02 | 6.0x6.5 | 0.236x0.256 | 1 |
| 58727778 | 037103105370 | Hot air nozzle | Q04 | 6.0x9.0 | 0.236x0.354 | 1 |
| 58727779 | 037103105424 | Hot air nozzle | D04 | 10.5x10.5 | 0.413x0.413 | 1 |
| 58727780 | 037103105363 | Hot air nozzle | Q06 | 15.0x10.0 | 0.591x0.394 | 1 |
| 58727781 | 037103105400 | Hot air nozzle | D08 | 15.0x10.0 | 0.591x0.394 | 1 |
| 58727782 | 037103105417 | Hot air nozzle | D06 | 13.0x10.0 | 0.512x0.394 | 1 |
| 58727783 | 037103105356 | Hot air nozzle | Q08 | 15.0x12.5 | 0.591x0.492 | 1 |
| 58727784 | 037103105394 | Hot air nozzle | D10 | 18.0x10.0 | 0.709x0.394 | 1 |
| 58727785 | 037103105349 | Hot air nozzle | Q10 | 18.0x18.0 | 0.709x0.709 | 1 |
| 58727786 | 037103105769 | Hot air nozzle | R08 | 2.0 Dia | 0.079 Dia. | 1 |
| 58727787 | 037103105288 | Hot air nozzle | R10 | 2.0 Dia. | 0.079 Dia. | 1 |
| 58727808 | 037103105332 | Hot air nozzle | R01 | - | - | 1 |

MT and MTG series tips for Marksman® irons

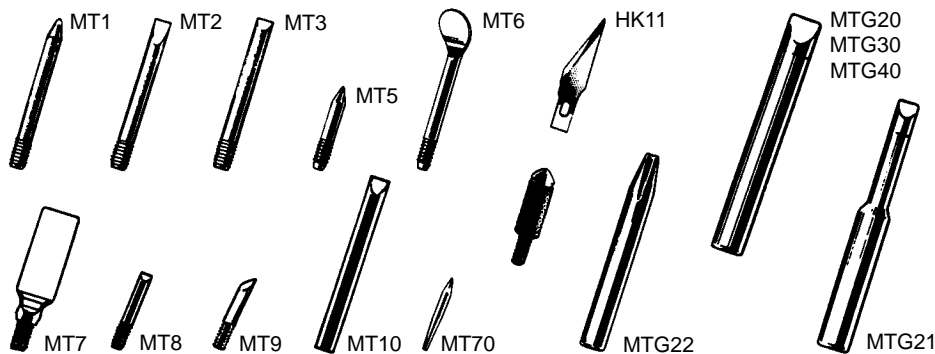

- Marksman® replacement tips
- Nickel-plated copper tips are available in a variety of styles
- MTG series tips are iron-plated for heavy-duty soldering irons
- Carded for point-of-purchase display
- Packed 6 and 10 cards per carton

| Cat No. | UPC No. | Description | Tip Size | | Packed | Shelf Pack |
|---------|--------------|-----------------------------|----------|----|--------|------------|
| | | | Inch | mm | | |
| MT1 | 037103472175 | SP23/SP25D Cone shaped tip | 1/8 | 3 | 2/card | 6Cds |
| MT2 | 037103472410 | SP23/SP25D Screwdriver tip | 1/8 | 3 | 2/card | 6Cds |
| MT3 | 037103472502 | SP23/SP25D Chisel tip | 1/8 | 3 | 2/card | 6Cds |
| MT5 | 037103472793 | SP23/SP25D Woodburning tip | 1/8 | 3 | 1/card | 6Cds |
| MT6 | 037103473004 | SP23/SP25D Smoother tip | 1/8 | 3 | 1/card | 6Cds |
| MT7 | 037103477835 | SP23/SP25D Macrame tip | - | - | 1/card | 6Cds |
| MT8 | 037103478061 | SP23WB Woodburning tip | 1/8 | 3 | 1/card | 10Cds |
| MT9 | 037103478078 | SP23WB Woodburning tip | 1/8 | 3 | 1/card | 10Cds |
| MT10 | 037103473615 | SP40/SP40D Chisel tip | 1/4 | 6 | 2/card | 6Cds |
| MT70 | 037103479808 | SP12 Cone shape tip | 1/8 | 3 | 2/card | 10Cds |
| MTG20 | 037103476593 | SPG80/WLC200 Chisel tip | 3/8 | 10 | 1/card | 6Cds |
| MTG21 | 037103476609 | SPG80/WLC200 Chisel tip | 1/4 | 6 | 1/card | 6Cds |
| MTG22 | 037103479822 | SPG80/WLC200 Cone shape tip | 3/8 | 10 | 1/card | 6Cds |
| MTG30 | 037103477903 | SP120/SP120D Chisel tip | 1/2 | 13 | 1/card | 6Cds |
| MTG40 | 037103478672 | SP175 Chisel tip | 5/8 | 16 | 1/card | 6Cds |
| HK11 | 037103473622 | SP23/SP25D Blade and Chuck | 1/8 | 3 | 1/card | 6Cds |

Tips for cordless soldering tools

WPT and WHC series tips for WSTA3 and WPA2 Pyropen® irons

查詢 3300299 供應商
19 soldering tip combinations available

- Multi-purpose catalyst and hot blow tip
- 3 inactive hot air nozzles for low temp heat
- **IMPORTANT:** Use only Weller soldering tips. Use of non-Weller components may void product warranty if the non-Weller component causes damage to the unit

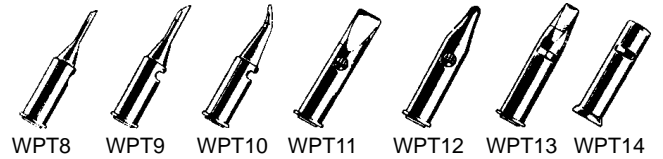
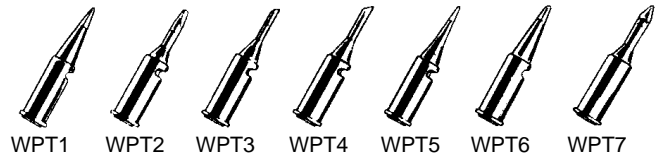

| Cat. No. | UPC No. | Description | Tip Size | | Shelf Pk. Wt. | | Shelf Pack |
|----------|--------------|--|----------|-----|---------------|-----|------------|
| | | | Inch | mm | lb | kg | |
| WPT1 | 037103472403 | Taper needle tip | - | - | 0.10 | .05 | 1 |
| WPT2 | 037103472427 | 2mm Chisel tip | .078 | 2 | 0.10 | .05 | 1 |
| WPT3 | 037103472441 | 2mm Spade tip | .078 | 2 | 0.10 | .05 | 1 |
| WPT4 | 037103472458 | 3mm 45° Spade tip | .118 | 3 | 0.10 | .05 | 1 |
| WPT5 | 037103472489 | Taper needle tip | - | - | 0.10 | .05 | 1 |
| WPT6 | 037103472496 | 2mm Micro Spade tip | .078 | 2 | 0.10 | .05 | 1 |
| WPT7 | 037103472526 | 0.5mm Sq. taper pyramid tip | .020 | 0.5 | 0.10 | .05 | 1 |
| WPT8 | 037103472533 | 2mm 35° Spade tip | .078 | 2 | 0.10 | .05 | 1 |
| WPT9 | 037103472540 | 3mm 35° Spade tip | .118 | 3 | 0.10 | .05 | 1 |
| WPT10 | 037103472557 | 1mm Offset taper needle tip | .040 | 1 | 0.10 | .05 | 1 |
| WPT11 | 037103472595 | 8mm High powered chisel tip | .315 | 8 | 0.10 | .05 | 1 |
| WPT12 | 037103472700 | 3mm High powered round head needle tip | .118 | 3 | 0.10 | .05 | 1 |
| WPT13 | 037103472786 | 5mm High powered long taper chisel tip | .197 | 5 | 0.10 | .05 | 1 |
| WPT14 | 037103472816 | 8.4mm Multi-purpose catalyst | .330 | 8.4 | 0.10 | .05 | 1 |
| WHC50 | 037103472823 | 2.5mm I.D. Hot blow tip | .098 | 2.5 | 0.10 | .05 | 1 |
| WHC51 | 037103472991 | 3.3mm I.D. Hot air tip | .130 | 3.3 | 0.10 | .05 | 1 |
| WHC52 | 037103473400 | 4.9mm I.D. Hot air tip | .193 | 4.9 | 0.10 | .05 | 1 |
| WHC53 | 037103473592 | 7.4mm I.D. Hot air tip | .291 | 7.4 | 0.10 | .05 | 1 |

WPT and WHC series tips for WST2 Pyropen® Jr iron

查询"53002699"供应商

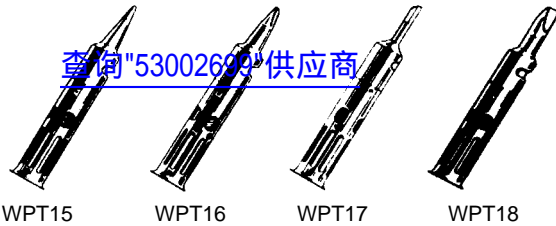

WPT15

WPT16

WPT17

WPT18



WHC54



WHC55

- “Longlife” tips last 10 times longer than conventional tips
- 4 soldering tip combinations available
- 2 inactive hot air nozzles for low temp heat
- IMPORTANT: Use only Weller soldering tips. Use of non-Weller components may void product warranty if the non-Weller component causes damage to the unit

| Cat. No. | UPC No. | Description | Pk. Wt. | | Shelf Pack |
|----------|--------------|--------------------------|---------|------|------------|
| | | | lb | kg | |
| WPT15 | 037103477521 | 0.5mm tapered needle tip | 0.10 | 0.05 | 1 |
| WPT16 | 037103477538 | 3.0mm Chisel point tip | 0.10 | 0.05 | 1 |
| WPT17 | 037103477545 | 3mm Spade point tip | 0.10 | 0.05 | 1 |
| WPT18 | 037103590831 | Stained glass tip | 0.10 | 0.05 | 1 |
| WHC54 | 037103477552 | 1.5mm Hot air tip | 0.10 | 0.05 | 1 |
| WHC55 | 037103477569 | 4.9mm Hot air tip | 0.10 | 0.05 | 1 |

PS series tips for Portasol® irons

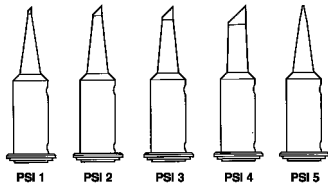

PSI 1

PSI 2

PSI 3

PSI 4

PSI 5

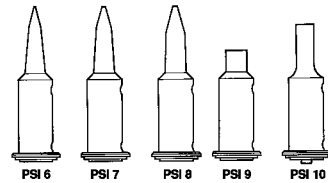

PSI 6

PSI 7

PSI 8

PSI 9

PSI 10

- Portasol® replacement tips for PSI100 tool
- Eight different size soldering tips to chose from
- One hot blower tip
- One hot knife tip
- Tips cannot be used with other Portasol® irons

Portasol® is a registered trademark of Oglesby and Butler Limited

| Cat. No. | UPC No. | Packed | Description | Pack Wt. | | Shelf Pack |
|----------|--------------|--------|---|----------|------|------------|
| | | | | lb | kg | |
| PSI 1 | 037103062666 | Carded | 1/32" (1.0mm) single flat Soldering Tip - temperature range up to 850°F (450°C) | 0.20 | 0.09 | 5 |
| PSI 2 | 037103062659 | Carded | 3/32" (2.4mm) single flat Soldering Tip - temperature range up to 850°F (450°C) | 0.20 | 0.09 | 5 |
| PSI 3 | 037103062628 | Carded | 1/8" (3.2mm) single flat Soldering Tip - temperature range up to 850°F (450°C) | 0.20 | 0.09 | 5 |
| PSI 4 | 037103062635 | Carded | 3/16" (4.8mm) single flat Soldering Tip - temperature range up to 850°F (450°C) | 0.20 | 0.09 | 5 |
| PSI 5 | 037103062604 | Carded | 1/32" (1.0mm) single flat Soldering Tip - temperature range up to 850°F (450°C) | 0.20 | 0.09 | 5 |
| PSI 6 | 037103062611 | Carded | 3/32" (2.4mm) double flat Soldering Tip - temperature range up to 850°F (450°C) | 0.20 | 0.09 | 5 |
| PSI 7 | 037103062581 | Carded | 1/8" (3.2mm) double flat Soldering Tip - temperature range up to 850°F (450°C) | 0.20 | 0.09 | 5 |
| PSI 8 | 037103062598 | Carded | 3/16" (4.8mm) double flat Soldering Tip - temperature range up to 850°F (450°C) | 0.20 | 0.09 | 5 |
| PSI 9 | 037103060983 | Carded | Hot Blower Tip -temperature range up to 850°F (450°C) | 0.20 | 0.09 | 5 |
| PSI 10 | 037103060990 | Carded | Hot Knife Tip -temperature range up to 850°F (450°C) | 0.20 | 0.09 | 5 |

T series tips for P1 Portasol® irons

- Portasol® replacement tips for P1 tool
- Soldering tips and heat tool accessories convert iron into 4 different tools: Soldering iron, Blow torch, Hot blower and Hot knife
- T1 to T4 tips temperature range up to 850°F (450°C)
- T5 blow torch temperature range up to 2372°F (1300°C)
- T6, hot blower and T7 hot knife temperature range up to 850°F (450°C)
- Portasol® is a registered trademark of Oglesby and Butler Limited

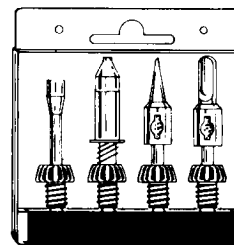
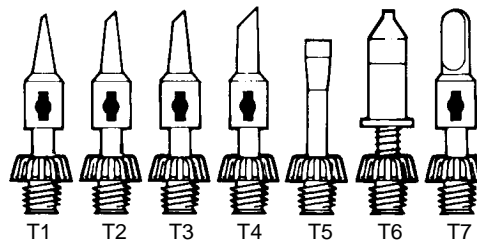

TB10 (T5, T6, T1, T7)

| Cat. No. | UPC No. | Description | Tip Size | | Reach | | Shelf Pk. Wt. | | Shelf Pack |
|----------|--------------|---|----------|------|-------|-------|---------------|------|------------|
| | | | Inch | mm | Inch | mm | lb | kg | |
| T1 | 037103593411 | Fine point soldering tip | 0.031 | 0.79 | 0.75 | 19.05 | 0.25 | 0.11 | 5 |
| T2 | 037103593429 | Spade tip | 0.093 | 2.38 | 0.75 | 19.05 | 0.25 | 0.11 | 5 |
| T3 | 037103593429 | Spade tip | 0.125 | 3.17 | 0.75 | 19.05 | 0.25 | 0.11 | 5 |
| T4 | 037103593443 | Spade tip | 0.187 | 4.74 | 0.75 | 19.05 | 0.25 | 0.11 | 5 |
| T5 | 037103593450 | Blow torch tip-temp range up to 2372°F | - | - | - | - | 0.25 | 0.11 | 5 |
| T6 | 037103593467 | Hot blower tip-temp range up to 850°F | - | - | - | - | 0.25 | 0.11 | 5 |
| T7 | 037103593399 | Hot knife tip-temp range up to 850°F | - | - | - | - | 0.25 | 0.11 | 5 |
| TB10 | 037103593405 | Tip kit; T1, T5, T6, T7 in durable case | - | - | - | - | 5.00 | 2.26 | 5 |

C1C Portasol® tips and accessories

- Portasol® replacement tips for C1C tool
- Interchangeable screw-in tip
- Catalytic converter provides powerful and safe flameless combustion
- Tips cannot be used with other Portasol® irons
- Chisel, fine and hot knife tips are available

Portasol® is a registered trademark of Oglesby and Butler Limited

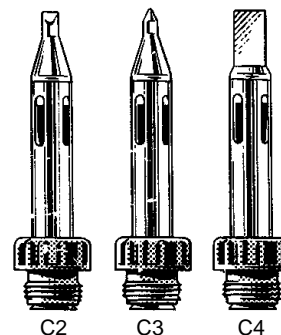

| Cat No. | UPC No. | Description | Tip Size | | Pack Wt. | | Shelf Pack |
|---------|--------------|---------------|----------|------|----------|-----|------------|
| | | | Inch | mm | lb | kg | |
| C2 | 037103001719 | Chisel tip | .12 | 3.17 | .25 | .11 | 5 |
| C3 | 037103001726 | Fine tip | .12 | 3.17 | .25 | .11 | 5 |
| C4 | 037103001702 | Hot knife tip | — | — | .25 | .11 | 5 |

Tiplets for desoldering tools

Threaded - DS110 to DS117

[查询"53002699"供应商](#)



DS110



DS111



DS112



DS113



DS114

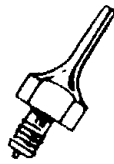

DS115

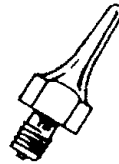

DS116



DS117

- Plated parts for contacting solder
- All tiplets have stainless steel liner brazed to tiplet for better heat transfer
- Entire tiplet is iron, nickel and chrome plated, then tinned
- Chrome plating eliminates need to apply anti-seizing compound on threads
- * Available bulk packed (100 multiples only); 200 lot minimum order quantity; greater discount offered to orders of 600 lots and above
- To order in bulk, add suffix "B" to Cat. No. eg: DS112B
- **IMPORTANT:** Use only Weller soldering tiplets. Use of non-Weller components may void product warranty if the non-Weller component causes damage to the unit

| Desoldering Station (Iron) | Standard Head | Alternate Head | Tiplet Style |
|---------------------------------------|-----------------|--------------------|---------------------|
| DS2000ESD, DS700M (DS1201ESD, DS1201) | DS219T DS229 | - DS219, DSH219 | Tapered Threaded |
| DS800 (DS1203A) | DS229 DSH219 | - DS219 | Tapered Threaded |
| DS700M (DS1201, DS1201ESD) | DS219T DS229 | - DS219, DSH219 | Tapered Threaded |
| DS600 (DS601P) | DS218T DS228 | - DS218, DS217 | Tapered Threaded |
| DS500 E (DS501) | DS229 DS219 | - DSH219 | Tapered Threaded |
| DS200/DS200K (DS1204A) | DS229 | - | Threaded |
| DS100 (DS102, DS501) | DS227 DS217 | - DS218 | Tapered Threaded |

| Cat. No. | UPC No. | Out. Diam. | | In. Diam. | | Reach | | Shelf Pk. Wt. | | Shelf Pack |
|----------|--------------|------------|------|-----------|------|-------|-------|---------------|------|------------|
| | | Inch | mm | Inch | mm | Inch | mm | lb | kg | |
| DS110 | 037103474384 | 0.062 | 1.52 | 0.024 | 0.63 | 0.50 | 12.70 | 1.50 | 0.68 | 5 |
| DS111 | 037103474391 | 0.093 | 2.28 | 0.024 | 0.63 | 0.50 | 12.70 | 1.50 | 0.68 | 5 |
| DS112* | 037103474414 | 0.078 | 1.93 | 0.031 | 0.91 | 0.50 | 12.70 | 1.50 | 0.68 | 5 |
| DS113* | 037103474445 | 0.093 | 2.48 | 0.046 | 1.16 | 0.50 | 12.70 | 1.50 | 0.68 | 5 |
| DS114* | 037103474452 | 0.125 | 3.25 | 0.073 | 1.80 | 0.50 | 12.70 | 1.50 | 0.68 | 5 |
| DS115 | 037103474476 | 0.062 | 1.52 | 0.024 | 0.63 | 0.75 | 19.05 | 1.50 | 0.68 | 5 |
| DS116 | 037103474490 | 0.093 | 2.48 | 0.043 | 1.14 | 0.75 | 19.05 | 1.50 | 0.68 | 5 |
| DS117 | 037103474513 | 0.093 | 2.28 | 0.024 | 0.63 | 0.75 | 19.05 | 1.50 | 0.68 | 5 |

Threaded - DSH110 to DSH114

- Presently used solely on DS1203, DS1203A, DS1204A high mass desoldering tool (DS800 and [查DS200DS200供应商](#))
- High mass tiptlets hold more heat than standard tiptlets
- Can transfer more heat to handle heavy multi-layer P.C. boards
- Makes desoldering faster...less chance of burning P.C. board
- Iron, nickel and chrome plated, then tinned tiptlets; chrome plating protects tiptlets from oxidation and prevents solder from creeping up outside of tiptlet
- **IMPORTANT:** Use only Weller soldering tiptlets. Use of non-Weller components may void product warranty if the non-Weller component causes damage to the unit

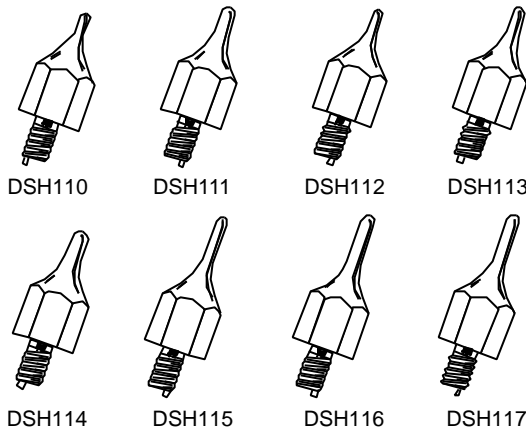

| Cat. No. | UPC No. | Out. Diam. | | In. Diam. | | Reach | | Shelf Pk. Wt. | | Shelf Pack |
|----------|--------------|------------|------|-----------|------|-------|-------|---------------|-----|------------|
| | | Inch | mm | Inch | mm | Inch | mm | lb | kg | |
| DSH110 | 037103593139 | 0.06 | 1.52 | 0.02 | 0.63 | 0.75 | 19.05 | 0.20 | .09 | 5 |
| DSH111 | 037103593269 | 0.09 | 2.28 | 0.02 | 0.63 | 0.75 | 19.05 | 0.20 | .09 | 5 |
| DSH112 | 037103593153 | 0.07 | 1.93 | 0.03 | 0.91 | 0.75 | 19.05 | 0.20 | .09 | 5 |
| DSH113 | 037103593160 | 0.09 | 2.48 | 0.04 | 1.14 | 0.75 | 19.05 | 0.20 | .09 | 5 |
| DSH114 | 037103593177 | 0.12 | 3.17 | 0.07 | 1.80 | 0.75 | 19.05 | 0.20 | .09 | 5 |
| DSH115 | 037103046420 | 0.062 | 1.52 | 0.024 | 0.63 | 0.75 | 19.05 | 0.20 | .09 | 5 |
| DSH116 | 037103046437 | 0.093 | 2.48 | 0.043 | 1.14 | 0.75 | 19.05 | 0.20 | .09 | 5 |
| DSH117 | 037103046444 | 0.093 | 2.48 | 0.024 | 0.63 | 0.75 | 19.05 | 0.20 | .09 | 5 |

Tapered - DS110T to DS117T

- Plated parts for contacting solder
- All tiptlets have stainless steel liner brazed to tiptlet for better heat transfer
- Iron, nickel and chrome plated, then tinned tiptlet
- **IMPORTANT:** Use only Weller soldering tiptlets. Use of non-Weller components may void product warranty if the non-Weller component causes damage to the unit

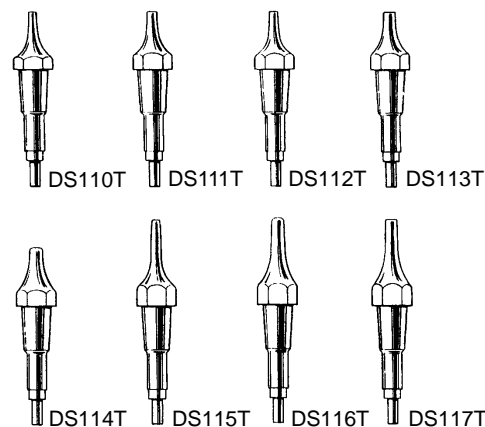

| Cat. No. | UPC No. | Out. Diam. | | In. Diam. | | Reach | | Shelf Pk. Wt. | | Shelf Pack |
|----------|--------------|------------|------|-----------|------|-------|-------|---------------|-----|------------|
| | | Inch | mm | Inch | mm | Inch | mm | lb | kg | |
| DS110T | 037103479839 | 0.062 | 1.52 | 0.024 | 0.63 | 0.50 | 12.70 | 0.20 | .09 | 1 |
| DS111T | 037103479846 | 0.093 | 2.28 | 0.024 | 0.63 | 0.50 | 12.70 | 0.20 | .09 | 1 |
| DS112T | 037103479853 | 0.078 | 1.93 | 0.031 | 0.91 | 0.50 | 12.70 | 0.20 | .09 | 1 |
| DS113T | 037103479860 | 0.093 | 2.48 | 0.046 | 1.16 | 0.50 | 12.70 | 0.20 | .09 | 1 |
| DS114T | 037103479877 | 0.125 | 3.17 | 0.073 | 1.80 | 0.50 | 12.70 | 0.20 | .09 | 1 |
| DS115T | 037103479884 | 0.062 | 1.52 | 0.024 | 0.63 | 0.75 | 19.05 | 0.20 | .09 | 1 |
| DS116T | 037103479891 | 0.093 | 2.48 | 0.043 | 1.14 | 0.75 | 19.05 | 0.20 | .09 | 1 |
| DS117T | 037103479907 | 0.093 | 2.28 | 0.024 | 0.63 | 0.75 | 19.05 | 0.20 | .09 | 1 |

Threaded - DST1 to DST6 for DS40P, DS60, DSTCP

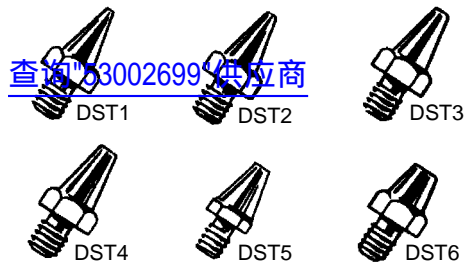

- Plated parts for contacting solder
- Nickel plated tiptlets
- * Available bulk packed (100 multiples only)
- Packaged 1 tip per card, 10 cards per box
- May be used with DS100, but with possibility of reduced tip life
- **IMPORTANT:** Use only Weller soldering tiptlets. Use of non-Weller components may void product warranty if the non-Weller component causes damage to the unit

| Cat. No. | UPC No. | Out. Diam. | | In. Diam. | | Reach | | Shelf Pk. Wt. | | Shelf Pack |
|----------|--------------|------------|------|-----------|------|-------|-------|---------------|-----|------------|
| | | Inch | mm | Inch | mm | Inch | mm | lb | kg | |
| DST1* | 037103472090 | 0.076 | 1.98 | 0.038 | 0.96 | 0.50 | 12.70 | 0.15 | .07 | 10 |
| DST2* | 037103472366 | 0.096 | 2.41 | 0.046 | 1.16 | 0.50 | 12.70 | 0.15 | .07 | 10 |
| DST3* | 037103472465 | 0.125 | 3.17 | 0.055 | 1.49 | 0.50 | 12.70 | 0.15 | .07 | 10 |
| DST4* | 037103472571 | 0.136 | 3.42 | 0.062 | 1.60 | 0.50 | 12.70 | 0.15 | .07 | 10 |
| DST5* | 037103472779 | 0.154 | 3.93 | 0.078 | 1.98 | 0.50 | 12.70 | 0.15 | .07 | 10 |
| DST6* | 037103472960 | 0.171 | 4.31 | 0.093 | 2.28 | 0.37 | 9.52 | 0.15 | .07 | 10 |

WDT series tiptlets for manual (WDP) desoldering pumps



- Standard and antistatic versions available
- Standard has Teflon* tip, antistatic (suffix "A") has carbon tip
- Tips screw into body of manual desoldering pump to ensure maintenance of strong vacuum
- *Teflon is a Registered Trademark of DuPont

| Cat. No. | UPC No. | Description | Shelf Pack Wt. | | Shelf Pack |
|----------|--------------|---------------------------------|----------------|------|------------|
| | | | lb | kg | |
| WDT07 | 037103480651 | Replacement tip .07" | 0.25 | 0.11 | 12 |
| WDT07A | 037103480675 | Replacement tip .07" Antistatic | 0.25 | 0.11 | 12 |
| WDT12 | 037103480644 | Replacement tip .12" | 0.31 | 0.14 | 12 |
| WDT12A | 037103480668 | Replacement tip .12" Antistatic | 0.31 | 0.14 | 12 |

Tiptlets for 5098AS desoldering pistol and 5088 desoldering iron

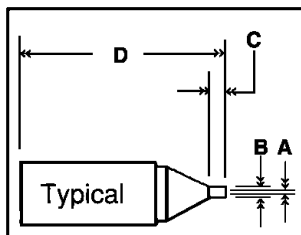

- Machined from special Ungar® Alloy #24
- Highly resistant to abrasion and erosion by solder
- Superior wear characteristics when compared to ordinary copper or composite type tips
- Plated to prevent corrosion

| Cat. No. | UPC No. | A | | B | | C | | D | | Shelf Pk. Wt. | | Shelf Pack |
|----------|--------------|------|------|------|------|------|------|-------|-------|---------------|------|------------|
| | | Inch | mm | Inch | mm | Inch | mm | Inch | mm | lb | kg | |
| 4005 | 037103059840 | .032 | 0.81 | .060 | 1.52 | 0.12 | 3.05 | 1.312 | 33.32 | .027 | 0.12 | 1 |
| 4006 | 037103059857 | .040 | 1.02 | .080 | 2.03 | 0.12 | 3.05 | 1.312 | 33.32 | .027 | 0.12 | 1 |
| 4007 | 037103059864 | .062 | 1.57 | .100 | 2.54 | 0.12 | 3.05 | 1.312 | 33.32 | .027 | 0.12 | 1 |
| 4008 | 037103059871 | .089 | 2.26 | .120 | 3.05 | 0.12 | 3.05 | 1.312 | 33.32 | .027 | 0.12 | 1 |
| 4009 | 037103059888 | .062 | 1.57 | .100 | 2.54 | 0.37 | 9.40 | 1.562 | 39.67 | .026 | 0.11 | 1 |
| 4012 | 037103059901 | .020 | 0.51 | .040 | 1.02 | 0.16 | 4.06 | 1.200 | 30.48 | .026 | 0.11 | 1 |

Desoldering accessories for Surface Mount Technology (SMT)

SMT tiptets (threaded) for DS200(K), DS500E, and DS800

[查询"53002699"供应商](#)

Threaded mount tiptet; used with desoldering tools fitted with threaded tiptet

- Makes quick work of flat or quad-pack desoldering w/o risk of damaging pads on circuit board
- Temperature controlled frame simultaneously melts solder of all connected leads
- Activate vacuum switch to gently lift component
- CSF accessories can also be used for soldering pre-tinned flat and quad packs
- Other CSF's can be produced, upon request, to meet other special specifications

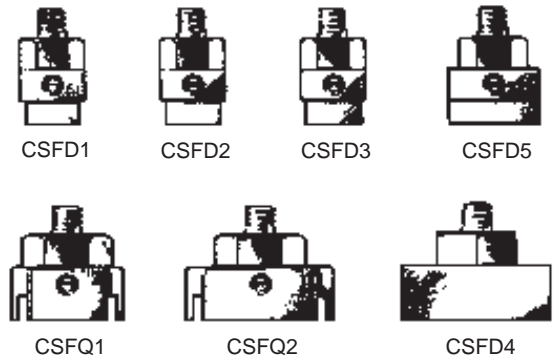
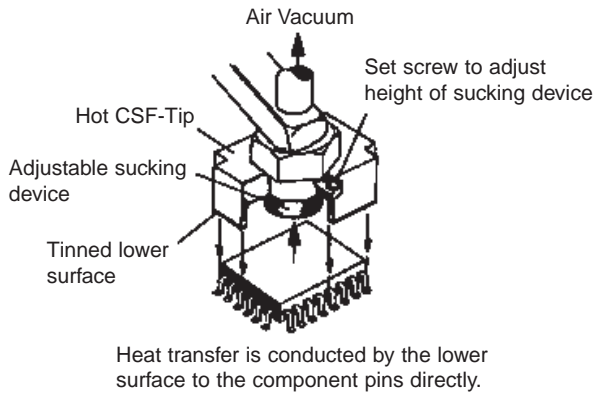
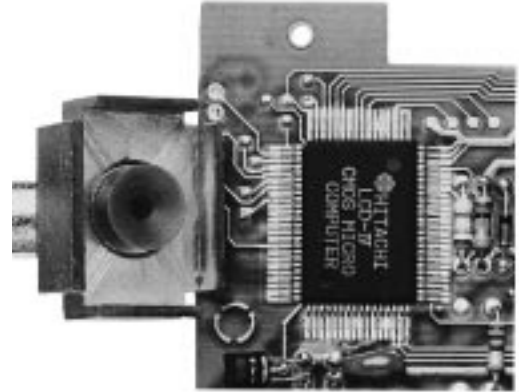

| Cat. No. | UPC No. | Description | Shelf Pack Wt. | | Shelf Pack |
|--------------------------|--------------|--|----------------|-----|------------|
| | | | lb | kg | |
| CSFD1 | 037103472144 | 5.2mm x 10.0mm size chip | .042 | .02 | 1 |
| CSFD2 | 037103472151 | 5.8mm x 10.5mm size chip | .042 | .02 | 1 |
| CSFD3 | 037103472168 | 6.7mm x 10.0mm size chip | .042 | .02 | 1 |
| CSFD4 | 037103472182 | 11.0mm x 26.5mm size chip | .073 | .03 | 1 |
| CSFD5 | 037103472205 | 10.0mm x 16.0mm size chip | .049 | .02 | 1 |
| CSFD6 | 037103593870 | 9.3mm x 13.0mm size chip | .336 | .15 | 1 |
| CSFD7 | 037103593887 | 9.4mm x 10.0mm size chip | .711 | .32 | 1 |
| CSFD8 | 037103593894 | 9.8mm x 18.0mm size chip | .711 | .32 | 1 |
| CSFD9 | 037103593900 | 10.5mm x 16.0mm size chip | .049 | .02 | 1 |
| CSFD10 | 037103593917 | 10.7mm x 18.0mm | .053 | .02 | 1 |
| CSFQ1 | 037103472236 | 17.0mm x 17.0mm size chip (4-sided) | .071 | .03 | 1 |
| CSFQ2 | 037103472243 | 17.0mm x 23.0mm size chip (4-sided) | .086 | .04 | 1 |
| CSFQ3 | 037103593924 | 12.0mm x 12.0mm size chip (4-sided) | .044 | .02 | 1 |
| CSFQ4 | 037103593818 | 12.0mm x 14.5mm size chip (4-sided) | .049 | .02 | 1 |
| CSFQ5 | 037103593825 | 12.7mm x 12.7mm size chip (4-sided) | .049 | .02 | 1 |
| CSFQ6 | 037103593832 | 19.6mm x 19.6mm size chip (4-sided) | .064 | .03 | 1 |
| CSFQI1 | 037103593849 | 12.7mm x 12.7mm | .046 | .02 | 1 |
| CSFQI2 | 037103593856 | 20.4mm x 20.4mm size chip (4-sided) | .099 | .05 | 1 |
| CSFQI3 | 037103593863 | 30.4mm x 30.4mm size chip (4-sided) | .179 | .08 | 1 |
| Replacement parts | | | | | |
| W58713798 | 037103590268 | CSF rubber insert - 10 per bag - small 3mm | .026 | .01 | 1 bag |
| W58713799 | 037103590275 | CSF rubber insert - 10 per bag - large 6mm | .022 | .01 | 1 bag |

SMT triplets (tapered) for DS2000ESD, DS700M, DS600 stations

- Tapered mount triplet, used with desoldering tools fitted with tapered desoldering head
- Makes quick work of flat or quad-pack desoldering w/o risk of damaging pads on circuit board
- Temperature controlled frame simultaneously melts solder of all connected leads
- Activate vacuum switch to gently lift component
- CSF accessories can also be used for soldering pre-tinned flat and quad packs
- Other CSF's can be quoted, upon request, to meet special specifications
- These are the same as threaded mount, only with a tapered mount

| Cat. No. | UPC No. | Description | Shelf Pack Wt. | | Shelf Pack |
|--------------------------|--------------|--|----------------|-----|------------|
| | | | lb | kg | |
| CSFD1T | 037103473844 | 5.2mm x 10.0mm size chip | .042 | .02 | 1 |
| CSFD2T | 037103473868 | 5.8mm x 10.5mm size chip | .044 | .02 | 1 |
| CSFD3T | 037103473882 | 6.7mm x 10.0mm size chip | .044 | .02 | 1 |
| CSFD4T | 037103473899 | 11.0mm x 26.5mm size chip | .075 | .03 | 1 |
| CSFD5T | 037103473929 | 10.0mm x 16.0mm size chip | .053 | .02 | 1 |
| CSFQ1T | 037103473936 | 17.0mm x 17.0mm size chip (4-sided) | .086 | .04 | 1 |
| CSFQ2T | 037103473943 | 17.0mm x 23.0mm size chip (4-sided) | .092 | .04 | 1 |
| Replacement parts | | | | | |
| W58713798 | 037103590268 | CSF rubber insert - 10 per bag - small 3mm | .026 | .01 | 1 bag |
| W58713799 | 037103590275 | CSF rubber insert - 10 per bag - large 6mm | .022 | .01 | 1 bag |

Consumer products WLC100

- On/off switch with "power-on" indicator light
- Variable power control produces 5-40 watts
- Quality lightweight pencil iron
- Cushioned foam grip with replaceable heating element
- Ideal for hobbyists, DIYers and students
- Safety guard iron holder
- Natural sponge tip cleaning pad
- ST3 iron plated copper tip
- ST series tips available
- See list of ST series tips on page Weller 63
- UL listed



| Cat. No. | UPC No. | Description | V | W | Hz | Shelf Pack Wt. | | Shelf Pack |
|----------|--------------|-----------------------------|-----|----|----|----------------|------|------------|
| | | | | | | lb | kg | |
| WLC100 | 037103059963 | Complete station w/40w iron | 120 | 40 | 60 | 2.5 | 1.13 | 1 |

Electronic soldering station

- Electronically controlled station with compact design, ideal for the novice soldering buff
- 40 watt soldering pencil, fitted with ETA tip can be used with the full range of Weller ET series tips
- Adjustable temperature from 350°F to 850°F, stable within $\pm 10^\circ\text{F}$ at idle
- Zero voltage circuit ensures no high voltage spikes or magnetic fields present at tip to damage sensitive components
- 3-wire grounded power cord, UL-recognized
- Lighted On/Off switch; impact-resistant housing and iron handle
- UL listed



| Cat. No. | UPC No. | Description | V | W | Hz | Shelf Pack Wt. | | Shelf Pack |
|-------------------|--------------|---------------------------------|-----|----|----|----------------|------|------------|
| | | | | | | lb | kg | |
| WCC100 | 037103592415 | Complete station w/40w iron | 120 | 60 | 60 | 2.5 | 1.13 | 1 |
| Replacement parts | | | | | | | | |
| WCC101 | 037103592538 | Soldering iron w/ETA tip | 120 | 42 | - | 0.50 | 0.22 | 1 |
| WCC102 | 037103592545 | Heater assembly for WCC101 iron | | | | - | - | 1 |
| WCC103 | 037103592552 | Sensor assembly for WC101 iron | | | | - | - | 1 |
| WCC104 | 037103592569 | Sponge | | | | - | - | 1 |
| WCC105 | 037103592576 | Spring and funnel assembly | | | | - | - | 1 |

Controlled-output field soldering irons

- Versatile controlled tool for field servicing
- Operates from suitable batteries or low voltage power source
- Complete with battery clips and 12' fused cord
- Soldering iron comes with a PTA7 tip and heats up to 700°F (370°C). (600°F and 800°F tips optional. See page Weller 61)
- **IMPORTANT:** Use only Weller tips. Use of non-Weller components may void product warranty if non-Weller component causes damage to the unit
- PT series tips listed on page Weller 62
- UL listed



| Cat. No. | UPC No. | Description | V | W | Hz | Shelf Pack Wt. | | Shelf Pack |
|----------|--------------|----------------------|-------|----|----|----------------|------|------------|
| | | | | | | lb | kg | |
| TCP12P | 037103476517 | Field soldering iron | 12-14 | 40 | - | 3.25 | 1.47 | 3 |
| TCP24P | 037103476524 | Field soldering iron | 24-28 | 40 | - | 3.25 | 1.47 | 3 |

Solid state soldering gun

- Temperature controlled with fast 6-second heat-up
- Interchangeable power heads give choice of 600°F (315°C) or 700°F (370°C) capability
- Designed for modern solid state electronic work
- Will not damage sensitive components
- Carded
- UL listed



| Cat. No. | UPC No. | Description | V | W | Hz | Shelf Pack Wt. | | Shelf Pack |
|--------------------------|--------------|---|-----|-----|----|----------------|------|------------|
| | | | | | | lb | kg | |
| GT7A | 037103473202 | Complete gun w/700°F power head & tip | 120 | 150 | 60 | 5.25 | 2.37 | 6 |
| GT6B | 037103472977 | Complete gun w/600°F power head & tip | 120 | 150 | 60 | 5.25 | 2.37 | 6 |
| GT7A3 | 037103473219 | Same as GT7A but w/3-wire cord | 120 | 150 | 60 | 5.25 | 2.37 | 6 |
| Replacement parts | | | | | | | | |
| 7A | 037103473196 | 700°F (370°C) power head w/.187" chisel tip | | | | 1.00 | 0.45 | 6 |
| 6B | 037103472830 | 600°F (315°C) power head w/.125" cone tip | | | | 1.00 | 0.45 | 6 |
| GT | 037103472014 | Handle only with trigger & cord | | | | - | - | 1 |
| GT3 | 037103472472 | Handle only with trigger & 3-wire cord | | | | - | - | 1 |

Fiber cutting tool

- Specially developed for fiber manufacturing
- Lightweight, easy to operate
- Makes easy work of cutting through synthetics in forms such as tie cord, rope, carpet backing and textiles
- Rapid heat-up time, (12 seconds to reach 1800°F)
- Designed and built for continuous operation (soldering guns are not)
- Some materials melt at lower temperatures, two standard settings; HIGH, 1800°F-2200°F and LOW, 900°F-1100°F
- Settings offer high efficiency performance plus cutting time reductions of up to 50% with some materials
- Replaceable plug-in power head



| Cat. No. | UPC No. | Description | V | W | Hz | Shelf Pack Wt. | | Shelf Pack |
|--------------------------|--------------|-------------------------------------|---|---|----|----------------|----|------------|
| | | | | | | lb | kg | |
| SNG100S | 037103028389 | Industrial heat gun - Short Tip | | | | | | |
| Replacement parts | | | | | | | | |
| SNG101L | 037103028358 | Power head for SNG100L | | | | - | - | 1 |
| SNG101S | 037103028365 | Power head for SNG100S | | | | - | - | 1 |
| SNG105 | 037103592187 | Handle assembly for SNG100L/SNG100S | | | | - | - | 1 |
| SNG110 | 037103592194 | Housing for SNG100L/SNG100S | | | | - | - | 1 |
| SNG111 | 037103592200 | PC board/switch for SNG100L/SNG100S | | | | - | - | 1 |

Soldering gun-Universal (140/100 watts)

- All purpose gun
- Fingertip trigger selection of high or low output from instant heat gun ready to solder in 6 seconds
- High efficiency tin plated, pure copper tip
- Light illuminates work
- Compact, balanced pistol-grip design
- Available with 2-wire and 3-wire cord
- Soldering hints booklet included
- Tips listed on page Weller 82
- UL listed



| Cat. No. | UPC No. | Description | V | W | Hz | Shelf Pack Wt. | | Shelf Pack |
|---|--------------|----------------------|-----|---------|-------|----------------|------|------------|
| | | | | | | lb | kg | |
| 8200 | 037103475848 | Soldering gun | 120 | 140/100 | 50/60 | 8.75 | 3.95 | 3 |
| 82003 | 037103475855 | Soldering gun 3-wire | 120 | 140/100 | 50/60 | 17.50 | 7.91 | 6 |
| The following is available only to authorized export distributors. Units not VDE or GS approved. | | | | | | | | |
| 8200D | 037103475978 | Soldering gun | 240 | 140 | 50/60 | 17.50 | 7.91 | 6 |

Soldering gun-Professional (260/200 watts)

- Heavy-duty gun
- High output gun w/2-position trigger selection of dual heats
- Heavy gauge, high efficiency, tin plated, copper tip comes up to temperature in 6 seconds
- Balanced pistol-grip design with twin lights to illuminate work
- Available with 2-wire or 3-wire cord
- Complete with soldering hints booklet
- Tips listed on page Weller 82
- UL listed



| Cat. No. | UPC No. | Description | V | W | Hz | Shelf Pack Wt. | | Shelf Pack |
|---|--------------|----------------------|-----|---------|-------|----------------|------|------------|
| | | | | | | lb | kg | |
| D550 | 037103475411 | Soldering gun | 120 | 260/200 | 50/60 | 5.00 | 2.26 | 3 |
| D5503 | 037103475435 | Soldering gun 3-wire | 120 | 260/200 | 50/60 | 10.00 | 4.52 | 6 |
| The following is available only to authorized export distributors. Units not VDE or GS approved. | | | | | | | | |
| 8250D | 037103475992 | Soldering gun | 240 | 220 | 50/60 | 5.00 | 2.26 | 6 |

Industrial soldering gun (300/200 watts)



- Reliable new industrial-quality tool
- Highest power output of all our soldering guns:
300 watts in high trigger position and
200 watts in low trigger position
- Features nickel-plated copper secondary, heat-resistant thermoplastic housing
- Nickel-plated copper tip
- Heavy-duty grounded cord
- Wide selection of soldering, cutting and smoothing tips available

| Cat No. | UPC No. | Description | V | W | Hz | Pack Wt. | | Shelf Pack |
|---------|--------------|---------------|-----|---------|-------|----------|------|------------|
| | | | | | | lb | kg | |
| D650 | 037103079480 | Soldering gun | 120 | 300/200 | 50/60 | 3.9 | 1.77 | 1 |

Soldering gun kit-Standard lightweight (75w)



- 7200 soldering gun in plastic case
- Coil of lead-free rosin core solder
- 2 soldering tips and instruction leaflet

| Cat. No. | UPC No. | Description | V | W | Hz | Shelf Pack Wt. | | Shelf Pack |
|----------|--------------|-------------------|-----|----|-------|----------------|------|------------|
| | | | | | | lb | kg | |
| 7200PK | 037103478801 | Soldering gun kit | 120 | 75 | 50/60 | 10.80 | 4.88 | 3 |

Soldering gun kit-Universal (140/100 watts)

- 8-piece kit with 8200 soldering gun
- Includes: 1 soldering tip; 1 sealing tip; 1 cutting tip; flux brush; soldering aid tool; coil of lead-free rosin core solder
- Sturdy plastic carrying case
- Soldering hints booklet
- For information on soldering gun, refer to Catalog Number 8200, page Weller 79
- UL listed



| Cat. No. | UPC No. | Description | V | W | Hz | Shelf Pack Wt. | | Shelf Pack |
|---|--------------|-------------------|-----|---------|-------|----------------|------|------------|
| | | | | | | lb | kg | |
| 8200PK | 037103475862 | Soldering gun kit | 120 | 140/100 | 50/60 | 12.00 | 5.42 | 3 |
| The following is available only to authorized export distributors. Units not VDE or GS approved. | | | | | | | | |
| 8200DPK | 037103475985 | Soldering gun kit | 240 | 140 | 50/60 | 12.00 | 5.42 | 3 |

Soldering gun kit-Professional (260/200 watts)

- 8-piece heavy duty kit with D550 soldering gun
- Includes: 1 soldering tip; 1 sealing tip; 1 cutting tip; flux brush; soldering aid tool; coil of lead-free rosin core solder
- Sturdy plastic carrying case
- Soldering hints booklet
- For information on soldering gun, refer to Catalog Number D550, page Weller 79
- UL listed



| Cat. No. | UPC No. | Description | V | W | Hz | Shelf Pack Wt. | | Shelf Pack |
|---|--------------|-------------------|-----|---------|-------|----------------|------|------------|
| | | | | | | lb | kg | |
| D550PK | 037103475428 | Soldering gun kit | 120 | 260/200 | 50/60 | 13.00 | 5.88 | 3 |
| The following is available only to authorized export distributors. Units not VDE or GS approved. | | | | | | | | |
| 8250DPK | 037103476005 | Soldering gun kit | 240 | 220 | 50/60 | 13.00 | 5.88 | 3 |

Replacement tips for soldering guns

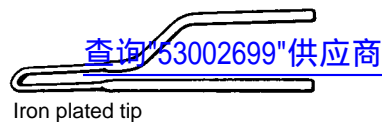

Iron plated tip



Cutting tip



Standard tip



Smoothing tip

- Complete line of cutting, smoothing, standard and tin plated tips, all made of copper, for Weller soldering guns
- **IMPORTANT:** Use only Weller soldering tips. Use of non-Weller components may void product warranty if the non-Weller component causes damage to the unit

| Cat. No. | UPC No. | Description | Shelf Pack |
|-------------------------|--------------|--|------------|
| Cutting tip | | | |
| 6110 | 037103475565 | Tip with hex nut for 8200/9200K | 6 |
| 6130 | 037103475589 | Tip with hex nut for D550 | 6 |
| 6130AN | 037103592002 | Tip with hex inserts & acorn nuts for D550 | 6 |
| 6150 | 037103480415 | Tip only for 8200/D550 | 6 |
| Smoothing tip | | | |
| 6120 | 037103475572 | Tip with hex nut for 8200/9200K | 6 |
| 6140 | 037103475596 | Tip with hex nut for D550 | 6 |
| 6140AN | 037103592019 | Tip with acorn nut for D550 | 6 |
| 6160 | 037103480422 | Tip only for 8200/D550 | 6 |
| Standard tip | | | |
| 7135 | 037103475657 | Tip only-2 per card for 8200/9200K | 6 |
| 7135N | 037103475664 | Tip with hex nut for 8200 | 6 |
| 7235 | 037103478818 | Tip only-2 per card for 7200 | 6 |
| 7250 | 037103475718 | Tip only-2 per card for D550 | 6 |
| 7250AN | 037103592026 | Tip with acorn nut for D550 | 6 |
| 7250N | 037103475725 | Tip with hex nut for D550 | 6 |
| Iron plated tip | | | |
| 8125 | 037103475824 | Tip only-2 per card for 8200 | 6 |
| 8125N | 037103475831 | Tip with hex nut for 8200 | 6 |
| Rope cutting tip | | | |
| RCT | 037103590237 | Rope cutting tip for 8200 | 6 |

Soldering gun accessories and parts

- Soldering gun replacement parts
- Please order part by catalog number and specify gun model number if not apparent within chart

| Cat. No. | UPC No. | Description | Shelf Pack |
|----------|--------------|---------------------------------------|------------|
| 4206 | 037103475558 | Flux brush | 1 |
| 7194 | 037103475671 | Light-bulb wedge type for N guns | 1 |
| 7323 | 037103475749 | Switch for single heat models | 1 |
| 7324 | 037103475756 | Switch for dual heat models | 1 |
| 7325 | 037103475763 | Tip nuts for models 8100, 8200 | 12 |
| 7417 | 037103475800 | Tip nuts for model D550 | 1 |
| 8200RH | 037103475879 | Right & left housings for 8200 series | 1 |
| D550RH | 037103475442 | Right & left housings for D550 series | 1 |

Mouser Electronics

Authorized Distributor

Click to View Pricing, Inventory, Delivery & Lifecycle Information:

[Apex Tool Group:](#)

[EC234FE](#) [EC1002-1](#) [DEC1001](#) [MT1500](#) [EC1002-2](#) [WTL-10001](#) [EC2002M-0](#) [EC10023](#)