

---

# Atmel AVR1912: Atmel XMEGA-B1 Xplained Hardware User Guide



## Features

- Atmel® ATxmega128B1 microcontroller
- 4x40 transfective LCD module with backlight
- One USB full/low speed device interface
- Analog input (to ADC)
  - Light sensor
  - Temperature sensor
  - External voltage input
  - Potentiometer voltage
- Digital I/O
  - Four Atmel QTouch® buttons
  - Four user LEDs
  - One power LED
  - Four expansion headers
- Footprints for external memory
  - Atmel AT45DB series DataFlash® serial flash
  - Atmel AT25DF series industry standard serial flash

## 1 Introduction

The Atmel XMEGA-B1 Xplained evaluation kit is a hardware platform to evaluate the ATxmega128B1 microcontroller.

The kit offers a large range of features that enables the Atmel AVR® XMEGA® user to get started right away using XMEGA peripherals and understand how to integrate the XMEGA device in their own design.

**Figure 1-1.** The XMEGA-B1 Xplained evaluation kit.

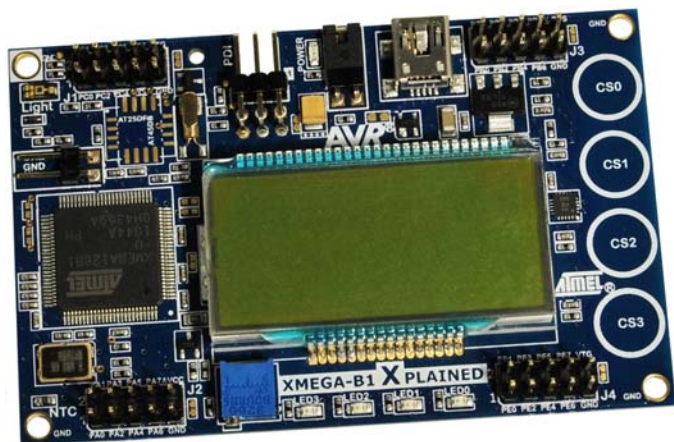

---

## 8-bit Atmel Microcontrollers

---

## Application Note

Rev. 8397A-AVR-10/2011





## 2 Related items

**Atmel AVR Studio® 5** (Atmel free IDE)

[http://www.atmel.com/dyn/products/tools\\_card.asp?tool\\_id=17212](http://www.atmel.com/dyn/products/tools_card.asp?tool_id=17212)

**Atmel AVR JTAGICE 3** (on-chip programming and debugging tool)

[http://www.atmel.com/dyn/products/tools\\_card.asp?tool\\_id=17213](http://www.atmel.com/dyn/products/tools_card.asp?tool_id=17213)

**Atmel AVR ONE!** (on-chip programming and debugging tool)

[http://www.atmel.com/dyn/products/tools\\_card.asp?tool\\_id=4279](http://www.atmel.com/dyn/products/tools_card.asp?tool_id=4279)

**Atmel AVR JTAGICE mkII** (on-chip programming and debugging tool)

[http://www.atmel.com/dyn/products/tools\\_card.asp?tool\\_id=3353](http://www.atmel.com/dyn/products/tools_card.asp?tool_id=3353)

**FLIP** (flexible in-system programmer)

[http://www.atmel.com/dyn/products/tools\\_card.asp?tool\\_id=3886](http://www.atmel.com/dyn/products/tools_card.asp?tool_id=3886)

## 3 General information

The schematic, layout, and bill of materials can be found in the zip files associated with this application note at:

<http://www.atmel.com/products/Xplained>.

The Atmel XMEGA-B1 Xplained kit is intended to demonstrate the Atmel ATxmega128B1 microcontroller.

**Figure 3-1.** Overview of the XMEGA-B1 Xplained kit.

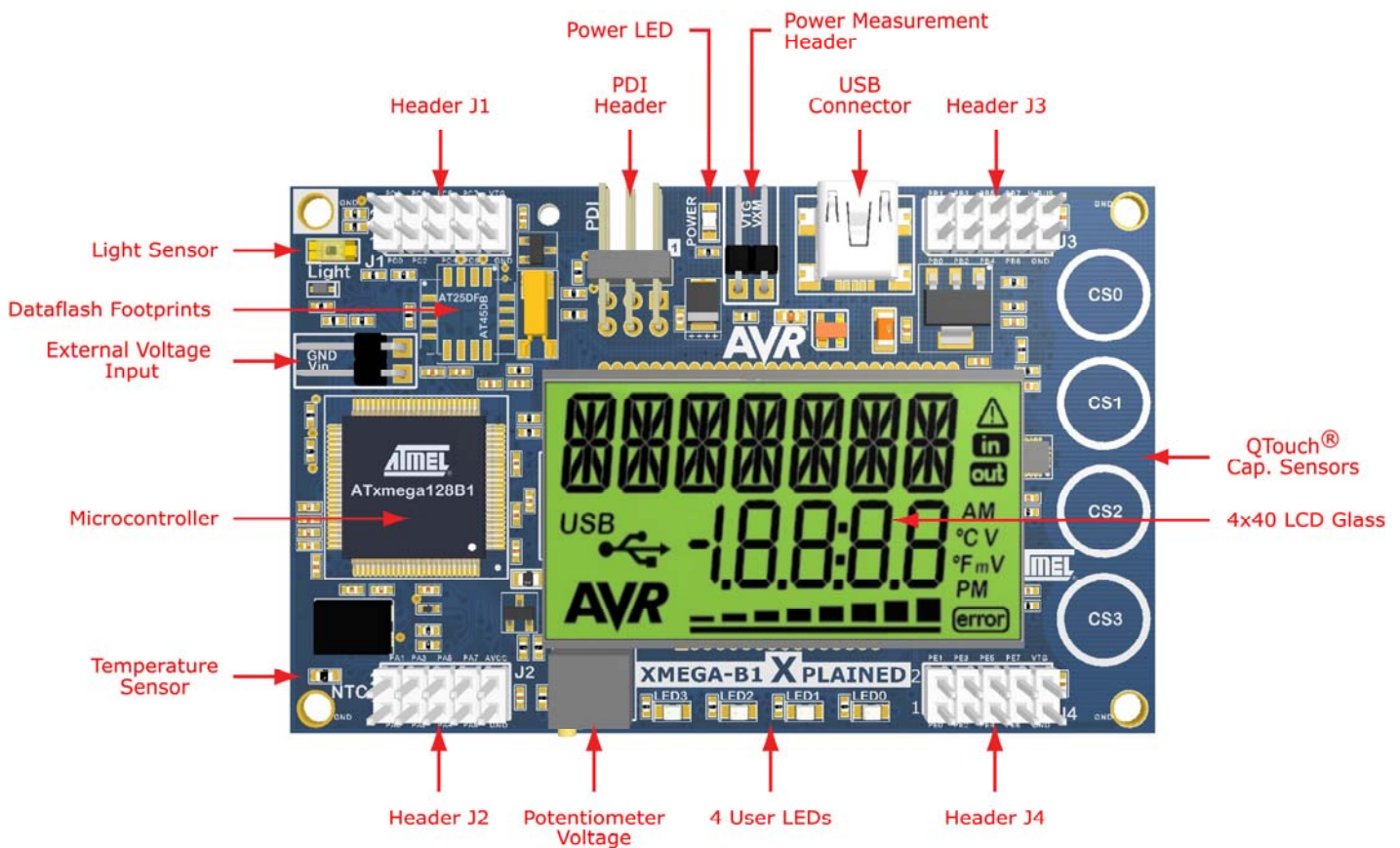
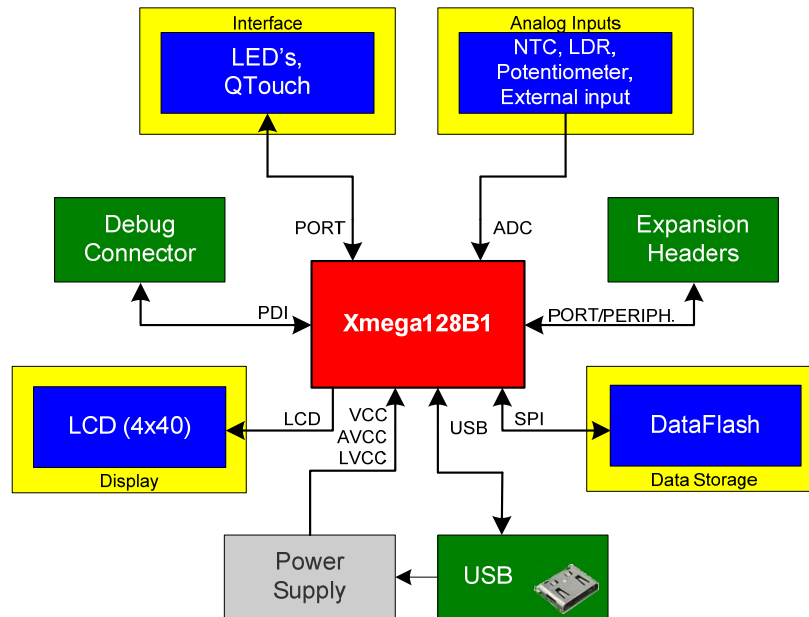



Figure 3-2. Functional overview of the Atmel XMEGA-B1 Xplained kit.



### 3.1 Preprogrammed firmware

The Atmel ATxmega128B1 that comes with the XMEGA-B1 Xplained kit is preprogrammed.

The preprogrammed firmware (see the application note, “AVR1619: XMEGA-B1 Xplained Demonstration”) in the ATxmega128B1 is set up with a demo that primarily highlights the use of the LCD, USB, and ADC modules.

The device also features a USB boot loader (see the application note, “AVR1916: USB DFU Boot Loader for ATxmega”) for the self-programming of the microcontroller. The boot loader can be started by shorting pin 6 of header J1 to GND while applying power to the board. The boot loader can be used with either FLIP or the batchISP command line tool (in the FLIP package).

### 3.2 Power supply

The kit is powered via the USB connector, which offers two options to power it: connect the kit to a PC with a USB cable or to a 5V USB power supply (AC/DC adapter).

The 5V supply voltage is regulated down to 3.3V with an onboard LDO regulator, which provides power to the entire board. The ATxmega128B1 is powered by 3.3V, but if operation at a lower voltage (1.8V min.) is desired, some modifications to the board are needed. This includes replacing the regulator with one that delivers the desired voltage and rerouting the power to the device (see schematic for explanation). As some of the other ICs on the XMEGA-B1 Xplained board require 3.3V to operate correctly, these devices have to be removed, also.

NOTE

The USB interface operates only if the ATxmega128B1 is powered by 3.3V.

### 3.3 Measuring Atmel ATxmega128B1 power consumption

As part of an evaluation of the ATxmega128B1, it may be of interest to measure its power consumption. The two-pin power measurement header, which has a jumper mounted on it, is the only connection between the common VTG (V\_Target) power plane and the VXM (V\_Xmega) power plane. By replacing the jumper with an ammeter, it is possible to determine the ATxmega128B1 current consumption. To locate the power measurement header, please refer to [Figure 3-1](#).

#### **WARNING**

*Do not power the board without having the jumper or an ammeter mounted. Otherwise, the device may be damaged.*

### 3.4 Programming the ATxmega128B1 through the USB interface

The ATxmega128B1 can be programmed through the USB interface. This can be accomplished using the USB boot loader that is preprogrammed in the device.

The boot loader is evoked by shorting pin 6 on J1 to GND before applying power to the board. A 100mil jumper can be used. Programming is performed through the FLIP plug-in in AVR Studio (which can also be started as a standalone application).

#### **NOTE**

If any external programming tool is used on the ATxmega128B1, the boot loader might be erased, and it will not be possible to program the device through the USB interface. In this case, the boot loader has to be restored (available on the Atmel website) with an external programming tool.



## 4 Connectors

The 90° angled, 6-pin, 100mil header is the PDI programming and debugging header for the Atmel ATxmega128B1.

The Atmel XMEGA-B1 Xplained board also has a USB 2.0 mini B connector.

The XMEGA-B1 Xplained board has four 10-pin, 100mil headers. Two of the headers provide a fixed communication interface (J1 and J4). One header provides analog functionality (J2), and the remaining header (J3) provides general purpose digital I/O.

For the location of the respective headers, refer to [Figure 3-1](#).

### 4.1 Programming and debugging header

The Atmel ATxmega128B1 can be programmed and debugged by connecting an external programming and debugging tool to the PDI header. The header has a standard PDI programmer pin-out (refer to online help in AVR Studio), and tools such as the Atmel JTAGICE 3, Atmel AVR ONE!, or Atmel AVR JTAGICE mkII can thus be connected to the PDI header. If it is desired to use PDI for programming and debugging, an adaptor must be used:

- (Dark blue) debugWIRE, SPI, PDI, aWire adaptor for JTAGICE 3, ref. A08-0735
- (Green) Standoff adaptor nr.3 JTAG/ISP for AVR ONE!, ref. A08-0254
- (White) XMEGA PDI adaptor for AVR JTAGICE mkII, ref. A09-0412

NOTE

The scoring in the board is made to fit the orientation tab on the connector.

**Table 4-1.** ATxmega128B1 programming and debugging the PDI interface.

Pin	PDI <sup>(1)</sup>	JTAGICE	AVR ONE!	JTAGICE mkII
1	PDI_DATA	debugWIRE, SPI, PDI, aWire adaptor  ref. A08-0735  Color: dark blue	Standoff adaptor nr.3 JTAG/ISP  ref. A08-0254  Color: green	XMEGA PDI adaptor  ref. A09-0412  Color: white
2	VTG (default 3.3V)			
3	(n.c.)			
4	(n.c.)			
5	PDI_CLOCK			
6	GND			

Note: 1. Standard pin-out for Atmel programming tools.

**Table 4-2.** Atmel programming and debugging tool interfaces.

JTAGICE 3, AVR ONE! 10-pin header		PDI signal	Squid cable colors	PDI signal	JTAGICE mkII 10-pin header	
Pin 1	TCK		Black (0)		TCK	Pin 1
Pin 2	GND	GND	White (1)	GND	GND	Pin 2
Pin 3	TDO	PDI_DATA	Grey (2)		TDO	Pin 3
Pin 4	VTref	VTG (default 3.3V)	Purple (3)	VTG (default 3.3V)	VTref	Pin 4
Pin 5	TMS		Blue (4)		TMS	Pin 5
Pin 6	nSRST	PDI_CLOCK	Green (5)	PDI_CLOCK	nSRST	Pin 6
Pin 7	(n.c.)		Yellow (6)		(n.c.)	Pin 7

JTAGICE 3, AVRONE! 10-pin header		PDI signal	Squid cable colors	PDI signal	JTAGICE mkII 10-pin header	
Pin 8	nTRST		Orange (7)		nTRST	Pin 8
Pin 9	TDI		Red (8)	PDI_DATA	TDI	Pin 9
Pin 10	GND		Brown (9)		GND	Pin 10

**NOTE**

The device also features a JTAG port for programming and debugging. To optimize the onboard I/O management, the JTAG pin allocation (PB[7:4]) is used to drive the user LEDs. The JTAG can be connected through the J3 header, but malfunctions may happen because of the LEDs. If a “clean” JTAG port is needed, the LED series resistors (or the LEDs themselves) can be removed. By default, the JTAG port is disabled by a fuse in the Atmel ATxmega128B1 mounted on the board.

## 4.2 USB connector

The USB 2.0 mini B receptacle is connected to the ATxmega128B1 to demonstrate the USB device feature of the product.

The onboard LDO regulator and the LCD backlight are powered by V\_BUS.

D+ and D- are directly connected to the microcontroller, and so the USB interface operates only if the ATxmega128B1 is powered (VTG) by 3.3V.

## 4.3 Expansion headers

There are four available I/O expansion headers on the Atmel XMEGA-B1 Xplained board. Because of the low pin count on the device (LCD pins deducted), the I/O expansion header pins are shared with onboard functionality. If “clean” expansion ports are needed, cut straps are available on some I/Os. Otherwise, it is needed to remove only a series resistor to eliminate onboard functionality. [Table 4-3](#) to [Table 4-6](#) show what is shared on the respective header pins.

### 4.3.1 Header – J1

**Table 4-3.** J1 I/O expansion header.

Pin	J1	XMEGA pin	Shared with onboard functionality
1	SDA <sub>TWI</sub>	PC0	-
2	SCL <sub>TWI</sub> / XCK0 <sub>USART</sub>	PC1	-
3	RXD0 <sub>USART</sub>	PC2	-
4	TXD0 <sub>USART</sub>	PC3	-
5	SS <sub>SPI</sub>	PC4	-
6	MOSI <sub>SPI</sub> / SCK <sub>USART-SPI</sub> XCK0 <sub>Swap USART</sub>	PC5	Serial flash clock (SCK <sub>USART-SPI</sub> )
7	MISO <sub>SPI</sub> / MISO <sub>USART-SPI</sub> RXD0 <sub>Swap USART</sub>	PC6	Serial flash output (MISO <sub>USART-SPI</sub> )
8	SCK <sub>SPI</sub> / MOSI <sub>USART-SPI</sub> TXD0 <sub>Swap USART</sub>	PC7	Serial flash input (MOSI <sub>USART-SPI</sub> )
9	GND	-	-
10	VTG (default 3.3V)	-	-





### 4.3.2 Header – J2

**Table 4-4.** J2 I/O expansion header.

Pin	J2	XMEGA pin	Shared with onboard functionality
1	ACA0 / ADCA0 / ADCB8	PA0	-
2	ACA1 / ADCA1 / ADCB9	PA1	-
3	ACA2 / ADCA2 / ADCB10	PA2	-
4	ACA3 / ADCA3 / ADCB11	PA3	-
5	ACA4 / ADCA4 / ADCB12	PA4	-
6	ACA5 / ADCA5 / ADCB13	PA5	-
7	ACA6 / ADCA6 / ADCB14	PA6	-
8	ACA7 / ADCA7 / ADCB15	PA7	-
9	GND	-	-
10	AVCC (default = VTG)	-	-

### 4.3.3 Header – J3

**Table 4-5.** J3 I/O expansion header.

Pin	J3	XMEGA pin	Shared with onboard functionality
1	ACB0 / ADCB0 / ADCA8	PB0	NTC sensor (ADCB0)
2	ACB1 / ADCB1 / ADCA9	PB1	Potentiometer measure (ADCB1)
3	ACB2 / ADCB2 / ADCA10	PB2	LDR sensor (ADCB2)
4	ACB3 / ADCB3 / ADCA11	PB3	External voltage measure (ADCB3)
5	ACB4 / ADCB4 / ADCA12 TMS <sub>JTAG</sub>	PB4	LED0 (PB4)
6	ACB5 / ADCB5 / ADCA13 TDI <sub>JTAG</sub>	PB5	LED1 (PB5)
7	ACB6 / ADCB6 / ADCA14 TCK <sub>JTAG</sub>	PB6	LED2 (PB6)
8	ACB7 / ADCB7 / ADCA15 TDO <sub>JTAG</sub>	PB7	LED3 (PB7)
9	GND	-	-
10	V_BUS (USB)	-	-

### 4.3.4 Header – J4

**Table 4-6.** J4 I/O expansion header.

Pin	J4	XMEGA pin	Shared with onboard functionality
1	OC0A <sub>TIM</sub> / OC0LA <sub>Split TIM</sub>	PE0	QTOUCH0 (PE0)
2	OC0B <sub>TIM</sub> / OC0LB <sub>Split TIM</sub> XCK0 <sub>USART</sub>	PE1	QTOUCH1 (PE1)
3	OC0C <sub>TIM</sub> / OC0LC <sub>Split TIM</sub> RXD0 <sub>USART</sub>	PE2	QTOUCH2 (PE2)
4	OC0D <sub>TIM</sub> / OC0LD <sub>Split TIM</sub> TXD0 <sub>USART</sub>	PE3	QTOUCH3 (PE3)
5	OC0A <sub>Swap TIM</sub> / OC0HA <sub>Split TIM</sub>	PE4	Power LED (PE4)



Pin	J4	XMEGA pin	Shared with onboard functionality
6	OC0B <sub>Swap TIM</sub> / OC0HB <sub>Split TIM</sub> XCK0 <sub>Swap USART</sub>	PE5	LCD backlight (OC0B <sub>Swap TIM</sub> )
7	OC0C <sub>Swap TIM</sub> / OC0HC <sub>Split TIM</sub> RXD0 <sub>Swap USART</sub>	PE6	RTC, 32.768kHz (TOSC2 <sub>Alternate</sub> )
8	OC0D <sub>Swap TIM</sub> / OC0HD <sub>Split TIM</sub> TXD0 <sub>Swap USART</sub>	PE7	RTC, 32.768kHz (TOSC1 <sub>Alternate</sub> )
9	GND	-	-
10	VTG (default 3.3V)	-	-

## 5 LCD

### 5.1 LCD module

The XMEGA-B1 Xplained board features an LCD module with 4 common terminals and 40 segment terminals. The display runs with a ¼ duty cycle and ⅓ bias, and is powered by 3.3V. The typical frame rate is 64Hz.

**Figure 5-1.** LCD segment (pixel) routing.

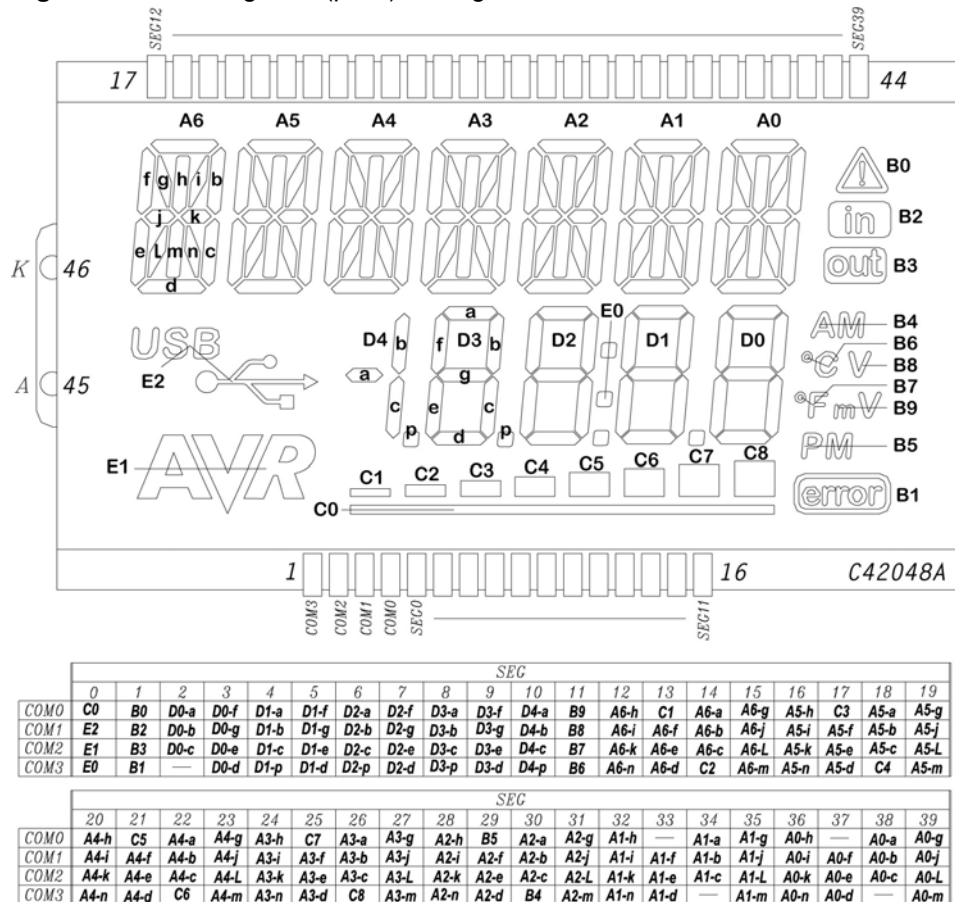

### 5.2 LCD backlight

The LCD backlight is controlled by PORTE on PE5. By default, it is not powered, and will switch on if PE5 = 1. A PWM signal can control the backlight. The LCD backlight voltage source is V\_BUS.

**Figure 5-2.** LCD backlight diagram.

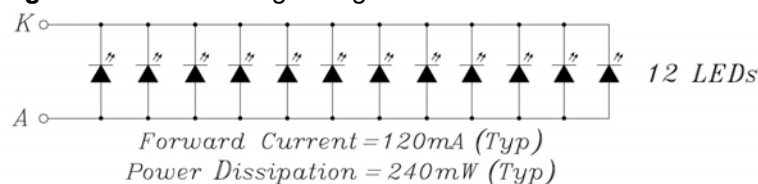

## 6 Memories

The Atmel XMEGA-B1 Xplained kit does not have any external memories mounted on the board, but footprints exist for adding serial flash.

### 6.1 Mounting

The footprint only allows mounting either an Atmel AT45DB series DataFlash serial flash memory, or an Atmel AT25DF series industry standard serial flash memory.

**Figure 6-1.** AT45DB series DataFlash memory horizontal mounting.

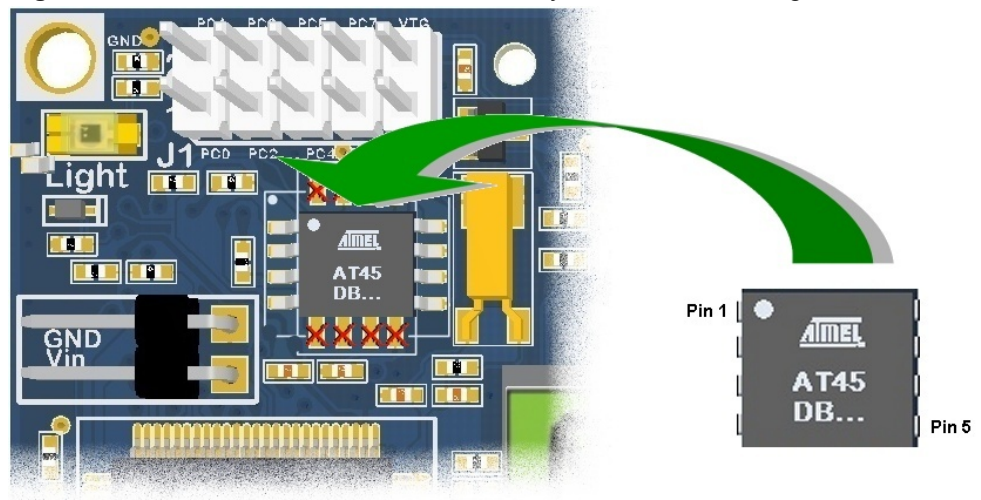

**Figure 6-2.** AT25DF series serial flash vertical mounting.

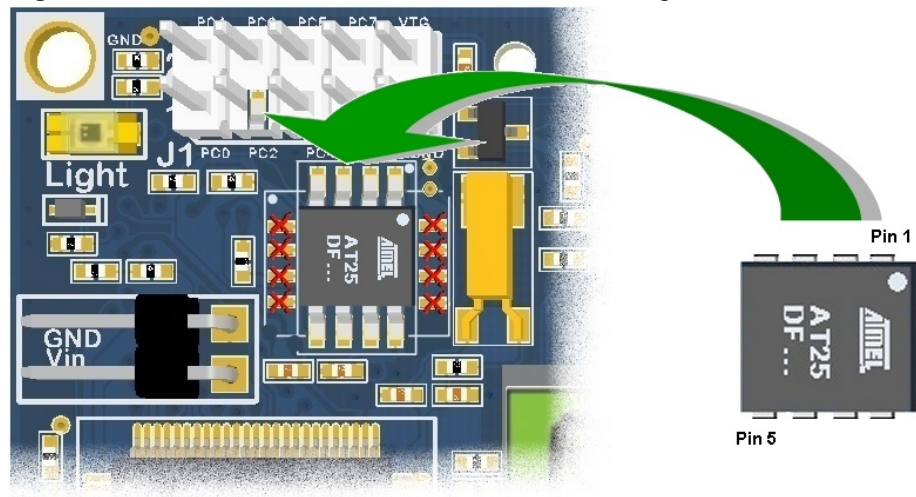

### 6.2 Connection

The serial interface for onboard the DataFlash memory uses the SPI master mode of the USART module. The main advantage of this configuration (USART vs. SPI) is the DMA support available on the USART in SPI master mode.



**Table 6-1.** Atmel XMEGA-B1 Xplained kit DataFlash connection.

DataFlash signal	XMEGA signal	XMEGA pin	Comment
SCK	SCK <sub>USART-SPI</sub>	PC5	Shared with J1
SO	MISO <sub>USART-SPI</sub>	PC6	Shared with J1
SI	MOSI <sub>USART-SPI</sub>	PC7	Shared with J1
/CS	(GPIO)	PD2	Onboard 100k $\Omega$ pull-up resistor

### 6.3 Compatible devices

**Table 6-2.** Compatible devices for the XMEGA-B1 Xplained kit serial flash footprints.

Atmel AT45DB Series Devices	Atmel AT25DF Series Devices
AT45DB64D2-CNU	AT25DF641A-SH
AT45DB321D-MWU	AT25DF321A-SH
AT45DB161D-SS	AT25DF161-SH
AT45DB081D-SS	AT25DF081-SSH
AT45DB041D-SS	AT25DF021-SSH
AT45DB021D-SS	
AT45DB011D-SS	

## 7 Miscellaneous I/Os

### 7.1 Touch

The board is equipped with four Atmel QTouch keys. The QTouch functionality is handled by a QTouch device, the Atmel AT42QT1040. Keys are included on the PCB itself (CS[3:0]). By default, the QTouch device is configured in ASK (Adjacent Key Suppression®) mode, and so key combinations are not possible.

An AT42QT1040 output pin goes active low when the corresponding key is touched. Because outputs are of the open-drain type, it is necessary to activate the internal pull-up resistors of PORTE (PE[7:4]) as soon as possible in the application firmware.

NOTE

Adding top modules to the board with functionality connected to these pins is not recommended. But, if no key is touched, the module functionality will run correctly.

NOTE

The QTouch device is very close to the keys. The sensitivity of the sensor lines on device's exposed pins is very high, and so touching its I/O pins will give erroneous results for the touch sensing mechanism.

### 7.2 LEDs

#### 7.2.1 User LEDs

Four yellow LEDs are connected to PORTB on PB[7:4]. The LEDs are active low, and lights up when the respective lines are output low by the Atmel ATxmega128B1.

#### 7.2.2 Power LED

The green LED, mounted near the PDI connector and labeled "POWER," indicates whether the output voltage generated by the regulator is present. It is connected to PORTE on PE4. This LED is powered by default, and will switch off when PE4 = 0.

### 7.3 Analog inputs

The Atmel XMEGA-B1 Xplained offers two sensors: a temperature sensor and a light sensor. In single-ended mode, it can also measure two analog inputs, one from the on-board potentiometer and one from a source that is external to the board.

#### 7.3.1 Temperature sensor

The temperature sensor employs an NTC thermistor connected to PORTB on pin PB0. The output range of the network containing the NTC is 0V – 1.1V (or 0V –  $\frac{1}{3}VTG$ ).

NTC reference: NCP18WF104J03RB.





**Figure 7-1.** NTC sensor – PB0 input voltage vs. temperature.

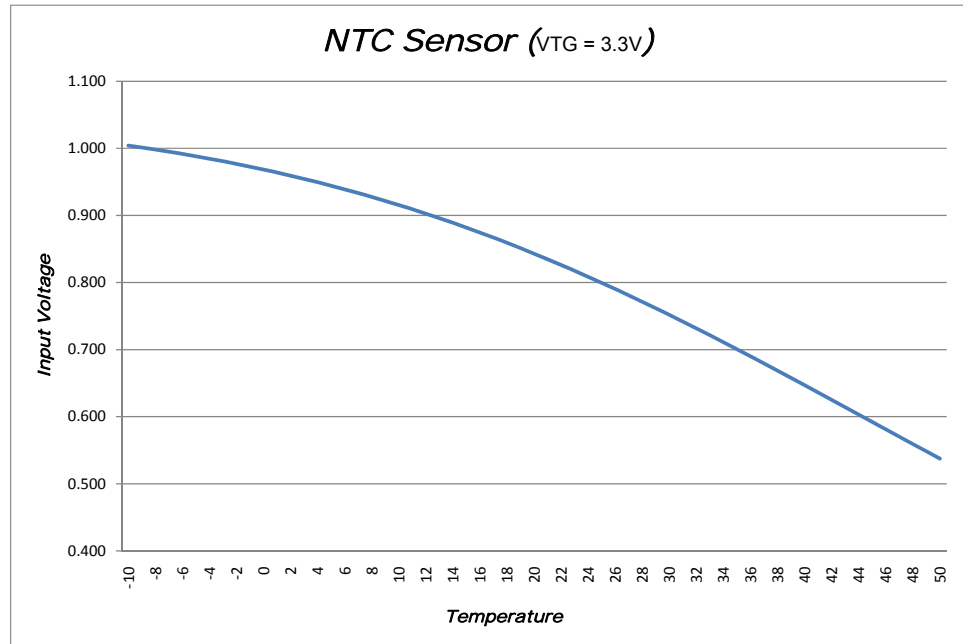

The NTC temperature range is  $-40^{\circ}\text{C}$  –  $+125^{\circ}\text{C}$ , and the input voltage range is  $1.047\text{V}$  –  $0.077\text{V}$  for  $\text{VTG} = 3.3\text{V}$ .

**Table 7-1.** NTC characteristics.

Temp. (°C)	Value (kΩ)	Temp. (°C)	Value (kΩ)	Temp. (°C)	Value (kΩ)	Temp. (°C)	Value (kΩ)
-30	2197.225	0	357.012	30	79.222	60	22.224
-29	2055.558	1	338.006	31	75.675	61	21.374
-28	1923.932	2	320.122	32	72.306	62	20.561
-27	1801.573	3	303.287	33	69.104	63	19.782
-26	1687.773	4	287.434	34	66.061	64	19.036
-25	1581.881	5	272.500	35	63.167	65	18.323
-24	1483.100	6	258.426	36	60.415	66	17.640
-23	1391.113	7	245.160	37	57.797	67	16.986
-22	1305.413	8	232.649	38	55.306	68	16.360
-21	1225.531	9	220.847	39	52.934	69	15.760
-20	1151.037	10	209.710	40	50.677	70	15.184
-19	1081.535	11	199.196	41	48.528	71	14.631
-18	1016.661	12	189.268	42	46.482	72	14.101
-17	956.080	13	179.890	43	44.533	73	13.592
-16	899.481	14	171.028	44	42.675	74	13.104
-15	846.579	15	162.651	45	40.904	75	12.635
-14	797.111	16	154.726	46	39.213	76	12.187
-13	750.834	17	147.232	47	37.601	77	11.757

Temp. (°C)	Value (kΩ)	Temp. (°C)	Value (kΩ)	Temp. (°C)	Value (kΩ)	Temp. (°C)	Value (kΩ)
-12	707.524	18	140.142	48	36.063	78	11.344
-11	666.972	19	133.432	49	34.595	79	10.947
-10	628.988	20	127.080	50	33.195	80	10.566
-9	593.342	21	121.066	51	31.859	81	10.200
-8	559.931	22	115.368	52	30.584	82	9.848
-7	528.602	23	109.970	53	29.366	83	9.510
-6	499.212	24	104.852	54	28.203	84	9.185
-5	471.632	25	100.000	55	27.091	85	8.873
-4	445.772	26	95.398	56	26.028	86	8.572
-3	421.480	27	91.032	57	25.013	87	8.283
-2	398.652	28	86.889	58	24.042	88	8.006
-1	377.193	29	82.956	59	23.113	89	7.738

### 7.3.2 Light sensor

The light sensor employs a light dependant resistor (LDR) connected to PORTB on pin PB2. The output range of the network containing the LDR is 0V – 1.1V (or 0V –  $\frac{1}{3}$ VTG).

When the light level is low, the resistance of the LDR is high, and the input voltage is close to 1.1V (or  $\frac{1}{3}$ VTG).

### 7.3.3 Potentiometer voltage

The single-ended output of the onboard potentiometer can be measured at PORTB on pin PB1. The input range is 0V – 0.666V (or 0V –  $\frac{1}{5}$ VTG).

### 7.3.4 External voltage input

An external voltage can be applied to the kit by using a header, as shown in [Figure 3-1](#). This voltage is routed to pin PB3 on PORTB of the Atmel XMEGA device, and can be determined by a single-ended measurement using the analog-to-digital converter (ADC). However, the external voltage is divided by eight before it is applied to the ADC, and this divider is fixed.

#### NOTE

A 2.0V Zener diode is mounted in parallel with the ADC input. This protects the ADC input from any over voltage. That effectively means that an external voltage between 0V-16V is allowed, assuming VTG is greater than 2.0V.

#### WARNING

*If VTG is lower than 2.0V, the ADC input is not protected and the external voltage input must be in the range of 0V – 8\*VTG. Otherwise, the device may be damaged.*



## 8 Further code examples and drivers

Several Getting Started training materials for the Atmel XMEGA-B1 Xplained kit can be downloaded from the Atmel website. These training materials offer a general introduction to Atmel ATxmega128B1 peripherals.

Further information and drivers for XMEGA devices can be downloaded as application notes, also distributed from the Atmel website.



**9 Known issues**

No known issues.



## 10 Revision history

The revision of the evaluation kit can be found on the bottom of the PCB.

Revision 4 of the Atmel XMEGA-B1 Xplained kit can be identified by a barcode sticker on the back side of the PCB with the following product ID: A09-1060/6.

### 10.1 Revision 6

Revision 6 is the first released version of the XMEGA-B1 Xplained kit, and it employs revision 3 of the PCB (product ID: A08-0840/3).

### 10.2 Revision 1 up to 5

Not released.

## **11 Evaluation board/kit important notice**

This evaluation board/kit is intended for use for **FURTHER ENGINEERING, DEVELOPMENT, DEMONSTRATION, OR EVALUATION PURPOSES ONLY**. It is not a finished product, and may not (yet) comply with some or any technical or legal requirements that are applicable to finished products, including, without limitation, directives regarding electromagnetic compatibility, recycling (WEEE), FCC, CE, or UL (except as may be otherwise noted on the board/kit). Atmel supplied this board/kit "AS IS," without any warranties, with all faults, at the buyer's and further users' sole risk. The user assumes all responsibility and liability for proper and safe handling of the goods. Further, the user indemnifies Atmel from all claims arising from the handling or use of the goods. Due to the open construction of the product, it is the user's responsibility to take any and all appropriate precautions with regard to electrostatic discharge and any other technical or legal concerns.

EXCEPT TO THE EXTENT OF THE INDEMNITY SET FORTH ABOVE, NEITHER USER NOR ATMEL SHALL BE LIABLE TO EACH OTHER FOR ANY INDIRECT, SPECIAL, INCIDENTAL, OR CONSEQUENTIAL DAMAGES.

No license is granted under any patent right or other intellectual property right of Atmel covering or relating to any machine, process, or combination in which such Atmel products or services might be or are used.

Mailing Address: Atmel Corporation, 2325 Orchard Parkway, San Jose, CA 95131.





## 12 Table of contents

<b>Features</b> .....	<b>1</b>
<b>1 Introduction</b> .....	<b>1</b>
<b>2 Related items</b> .....	<b>2</b>
<b>3 General information</b> .....	<b>3</b>
3.1 Preprogrammed firmware.....	4
3.2 Power supply.....	4
3.3 Measuring Atmel ATxmega128B1 power consumption.....	5
3.4 Programming the ATxmega128B1 through the USB interface.....	5
<b>4 Connectors</b> .....	<b>6</b>
4.1 Programming and debugging header.....	6
4.2 USB connector.....	7
4.3 Expansion headers.....	7
4.3.1 Header – J1.....	7
4.3.2 Header – J2.....	8
4.3.3 Header – J3.....	8
4.3.4 Header – J4.....	8
<b>5 LCD</b> .....	<b>10</b>
5.1 LCD module.....	10
5.2 LCD backlight.....	10
<b>6 Memories</b> .....	<b>11</b>
6.1 Mounting.....	11
6.2 Connection.....	11
6.3 Compatible devices.....	12
<b>7 Miscellaneous I/Os</b> .....	<b>13</b>
7.1 Touch.....	13
7.2 LEDs.....	13
7.2.1 User LEDs.....	13
7.2.2 Power LED.....	13
7.3 Analog inputs.....	13
7.3.1 Temperature sensor.....	13
7.3.2 Light sensor.....	15
7.3.3 Potentiometer voltage.....	15
7.3.4 External voltage input.....	15
<b>8 Further code examples and drivers</b> .....	<b>16</b>
<b>9 Known issues</b> .....	<b>17</b>
<b>10 Revision history</b> .....	<b>18</b>
10.1 Revision 6.....	18

10.2 Revision 1 up to 5.....	18
<b>11 Evaluation board/kit important notice.....</b>	<b>19</b>
<b>12 Table of contents .....</b>	<b>20</b>



**Atmel Corporation**  
2325 Orchard Parkway  
San Jose, CA 95131  
USA  
**Tel:** (+1)(408) 441-0311  
**Fax:** (+1)(408) 487-2600  
[www.atmel.com](http://www.atmel.com)

**Atmel Asia Limited**  
Unit 01-5 & 16, 19F  
BEA Tower, Millennium City 5  
418 Kwun Tong Road  
Kwun Tong, Kowloon  
HONG KONG  
**Tel:** (+852) 2245-6100  
**Fax:** (+852) 2722-1369

**Atmel Munich GmbH**  
Business Campus  
Parkring 4  
D-85748 Garching b. Munich  
GERMANY  
**Tel:** (+49) 89-31970-0  
**Fax:** (+49) 89-3194621

**Atmel Japan**  
9F, Tonetsu Shinkawa Bldg.  
1-24-8 Shinkawa  
Chou-ku, Tokyo 104-0033  
JAPAN  
**Tel:** (+81) 3523-3551  
**Fax:** (+81) 3523-7581

© 2011 Atmel Corporation. All rights reserved.

Atmel®, Atmel logo and combinations thereof, AVR®, AVR Studio®, Adjacent Key Suppression®, DataFlash®, QTouch®, XMEGA®, and others are registered trademarks or trademarks of Atmel Corporation or its subsidiaries. Other terms and product names may be trademarks of others.

**Disclaimer:** The information in this document is provided in connection with Atmel products. No license, express or implied, by estoppel or otherwise, to any intellectual property right is granted by this document or in connection with the sale of Atmel products. **EXCEPT AS SET FORTH IN THE ATMEL TERMS AND CONDITIONS OF SALES LOCATED ON THE ATMEL WEBSITE, ATMEL ASSUMES NO LIABILITY WHATSOEVER AND DISCLAIMS ANY EXPRESS, IMPLIED OR STATUTORY WARRANTY RELATING TO ITS PRODUCTS INCLUDING, BUT NOT LIMITED TO, THE IMPLIED WARRANTY OF MERCHANTABILITY, FITNESS FOR A PARTICULAR PURPOSE, OR NON-INFRINGEMENT. IN NO EVENT SHALL ATMEL BE LIABLE FOR ANY DIRECT, INDIRECT, CONSEQUENTIAL, PUNITIVE, SPECIAL OR INCIDENTAL DAMAGES (INCLUDING, WITHOUT LIMITATION, DAMAGES FOR LOSS AND PROFITS, BUSINESS INTERRUPTION, OR LOSS OF INFORMATION) ARISING OUT OF THE USE OR INABILITY TO USE THIS DOCUMENT, EVEN IF ATMEL HAS BEEN ADVISED OF THE POSSIBILITY OF SUCH DAMAGES.** Atmel makes no representations or warranties with respect to the accuracy or completeness of the contents of this document and reserves the right to make changes to specifications and product descriptions at any time without notice. Atmel does not make any commitment to update the information contained herein. Unless specifically provided otherwise, Atmel products are not suitable for, and shall not be used in, automotive applications. Atmel products are not intended, authorized, or warranted for use as components in applications intended to support or sustain life.

# Mouser Electronics

Authorized Distributor

Click to View Pricing, Inventory, Delivery & Lifecycle Information:

[Microchip:](#)

[ATXMEGAB1-XPLD](#)