

## 5V/3.3V Dual Differential Data and Clock D Flip-Flop with Set and Reset

### Features

- 3.3V and 5V Power Supply Option
- Differential D, CLK and Q
- Extended  $V_{EE}$  Range of  $-3.0V$  to  $-5.5V$
- VBB Output for Single-Ended Use
- 1100 MHz Min. Toggle Frequency
- Asynchronous Reset and Set
- Available in 20-Pin SOIC Package

### Package Type

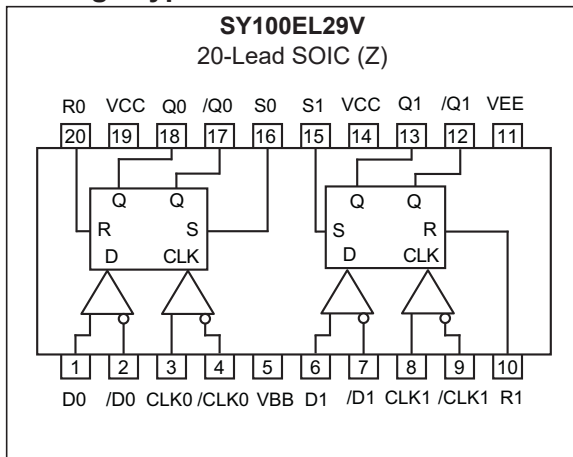

### General Description

The SY100EL29V is a dual differential register with differential data (inputs and outputs) and clock. The registers are triggered by a positive transition of the positive clock (CLK) input. A HIGH on the Reset (Rx) asynchronously resets the appropriate register so that the Q outputs go LOW. A HIGH on the Set (Sx) asynchronously resets the appropriate register so that the Q outputs go HIGH. The Set and Reset inputs cannot both be HIGH simultaneously.

The differential input structures are clamped so that the inputs of unused registers can be left open without upsetting the bias network of the devices. The clamping action will assert the /D and the /CLK sides of the inputs. The non-inverting input will pull down to  $V_{EE}$  and the inverting input will be biased around  $V_{CC}/2$ . Because of the edge-triggered flip-flop nature of the devices, simultaneously opening both the clock and data inputs will result in an output which reaches an unidentified but valid state.

The fully differential design of the devices makes them ideal for very high frequency applications where a registered data path is necessary.

# SY100EL29V

## 1.0 ELECTRICAL CHARACTERISTICS

### Absolute Maximum Ratings †

PECL Power Supply Voltage ( $V_{CC}$ ) (Note 1)	+8V
NECL Power Supply Voltage ( $V_{EE}$ ) (Note 2)	-8V
PECL Mode Input Voltage ( $V_{IN}$ ) (Note 3)	+6V
NECL Mode Input Voltage ( $V_{IN}$ ) (Note 4)	-6V
Continuous Output Current ( $I_{OUT}$ )	50 mA
Surge Output Current ( $I_{OUT}$ )	100 mA

† **Notice:** Stresses above those listed under “Absolute Maximum ratings” may cause permanent damage to the device. Exposure to maximum rating conditions for extended periods may affect device reliability.

**Note 1:**  $V_{EE} = 0V$ .

**2:**  $V_{CC} = 0V$ .

**3:**  $V_{EE} = 0V$ ,  $V_{IN} \leq V_{CC}$ .

**4:**  $V_{CC} = 0V$ ,  $V_{IN} \geq V_{EE}$ .

### DC ELECTRICAL CHARACTERISTICS

**Electrical Characteristics:**  $V_{CC} = 3.0V$  to  $5.5V$ ,  $V_{EE} = 0V$  or  $V_{EE} = -5.5V$  to  $-3.0V$ ,  $V_{CC} = 0V$ ;  
 $T_A = -40^\circ C$  to  $+85^\circ C$ , unless otherwise stated. (Note 1)

Parameter	Symbol	Min.	Typ.	Max.	Units	Conditions
Power Supply Current	$I_{EE}$	—	30	50	mA	$T_A = +25^\circ C$
		—	—	50		$T_A = -40^\circ C, 0^\circ C, +85^\circ C$
Output High Voltage (Note 2)	$V_{OH}$	$V_{CC} - 1.085$	$V_{CC} - 1.005$	$V_{CC} - 0.88$	V	$T_A = -40^\circ C$
		$V_{CC} - 1.025$	$V_{CC} - 0.955$	$V_{CC} - 0.88$		$T_A = 0^\circ C$ to $+85^\circ C$
Output Low Voltage (Note 2)	$V_{OL}$	$V_{CC} - 1.830$	$V_{CC} - 1.695$	$V_{CC} - 1.555$	V	$T_A = -40^\circ C$
		$V_{CC} - 1.810$	$V_{CC} - 1.705$	$V_{CC} - 1.620$		$T_A = 0^\circ C$ to $+85^\circ C$
Input High Voltage (Single-Ended)	$V_{IH}$	$V_{CC} - 1.165$	—	$V_{CC} - 0.880$	V	—
Input Low Voltage (Single-Ended)	$V_{IL}$	$V_{CC} - 1.810$	—	$V_{CC} - 1.475$	V	—
Output Reference Voltage	$V_{BB}$	$V_{CC} - 1.38$	—	$V_{CC} - 1.26$	V	—
Common Mode Range (Note 3)	$V_{IHCMR}$	$V_{EE} + 1.3$	—	$V_{CC} - 0.4$	V	$T_A = -40^\circ C$ , $V_{PP} < 500$ mV
		$V_{EE} + 1.2$	—	$V_{CC} - 0.4$		$T_A = 0^\circ C$ to $85^\circ C$ , $V_{PP} < 500$ mV
		$V_{EE} + 1.5$	—	$V_{CC} - 0.4$		$T_A = -40^\circ C$ , $V_{PP} \geq 500$ mV
		$V_{EE} + 1.4$	—	$V_{CC} - 0.4$		$T_A = 0^\circ C$ to $85^\circ C$ , $V_{PP} \geq 500$ mV
Input High Current	$I_{IH}$	—	—	150	$\mu A$	—
Input Low Current	$I_{IL}$	0.5	—	—	$\mu A$	D, CLK, R, S
		-300	—	—	$\mu A$	/D, /CLK

**Note 1:** Devices are designed to meet the DC specifications shown in the above table after thermal equilibration has been established. The circuit is in a test socket or mounted on a printed circuit board and transverse airflow greater than 500 lpm is maintained.

**2:** Outputs are terminated through a  $50\Omega$  resistor to  $V_{CC} - 2.0V$ .

**3:** The CMR range is referenced to the most positive side of the differential input voltage. Normal operation is obtained if the high level falls within the specified range and the peak-to-peak voltage lies between 150 mV and 1V.

## AC ELECTRICAL CHARACTERISTICS

**Electrical Characteristics:**  $V_{CC} = +3.0V$  to  $+5.5V$ ,  $V_{EE} = 0V$  or  $V_{EE} = -5.5V$  to  $-3.0V$ ,  $V_{CC} = 0V$ ;  $T_A = -40^{\circ}C$  to  $+85^{\circ}C$ ,  $R_L = 50\Omega$  to  $V_{CC} - 2V$ ; unless otherwise stated.

Parameter	Symbol	Min.	Typ.	Max.	Units	Conditions
Maximum Toggle Frequency	$f_{MAX}$	1.1	—	—	GHz	—
Propagation Delay (CLK to Q)	$t_{PD}$	480	—	680	ps	$T_A = -40^{\circ}C$
		490	—	690		$T_A = 0^{\circ}C$
		500	—	700		$T_A = +25^{\circ}C$
		520	—	720		$T_A = +85^{\circ}C$
Propagation Delay (S, R to Q)		450	—	670		—
Set-Up Time (D-to-CLK)	$t_S$	200	—	—	ps	—
Hold Time (CLK-to-D)	$t_H$	150	—	—	ps	—
Reset Recovery Time	$t_{RR}$	300	—	—	ps	—
Minimum Pulse Width (CLK, R, S)	$t_{PW}$	400	—	—	ps	—
Input Swing (Note 1)	$V_{PP}$	150	—	1000	mV	—
Output Rise/Fall Time Q (20% to 80%)	$t_r/t_f$	280	330	550	ps	$T_A = +25^{\circ}C$
		280	—	550		$T_A = -40^{\circ}C, 0^{\circ}C, +85^{\circ}C$

**Note 1:** Input swing for which AC parameters are guaranteed.

# SY100EL29V

---

---

## TEMPERATURE SPECIFICATIONS

Parameters	Symbol	Min.	Typ.	Max.	Units	Conditions
<b>Temperature Ranges</b>						
Operating Temperature Range	$T_A$	-40	—	+85	°C	—
Storage Temperature	$T_S$	-65	—	+150	°C	—
Lead Temperature	$T_{LEAD}$	—	—	+260	°C	Soldering, 20 sec.
<b>Package Thermal Resistance (SOIC)</b>						
Junction-to-Ambient	$\theta_{JA}$	—	90	—	°C/W	Still Air
		—	60	—		500 lfpm
Junction-to-Case	$\theta_{JC}$	—	35	—	°C/W	—

## 2.0 PIN DESCRIPTIONS

The descriptions of the pins are listed in [Table 2-1](#).

**TABLE 2-1: PIN FUNCTION TABLE**

Pin Name	Description
CLK, /CLK	Differential Clock Inputs.
D, /D	Differential Data Inputs.
/Q, Q	Differential Data Outputs.
R0, R1	Reset Inputs.
S0, S1	Set Inputs.
VBB	Reference Output.
VCC	Positive Supply Voltage.
VEE	Negative Supply Voltage.

## 2.1 Truth Table

**TABLE 2-2: TRUTH TABLE**

R	S	D	CLK	Q	/Q
L	L	L	Z	L	H
L	L	H	Z	H	L
H	L	X	X	L	H
L	H	X	X	H	L
L	H	X	X	Undef	Undef

**Note:** Z = Low-to-high transition.



# SY100EL29V

---

## 3.0 PACKAGING INFORMATION

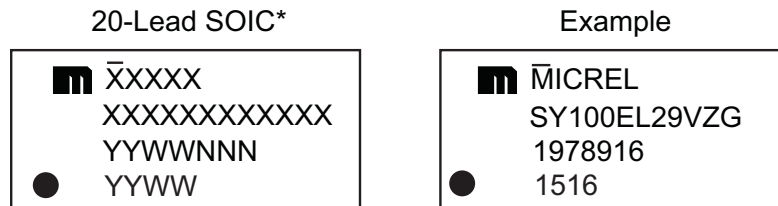
### 3.1 Package Marking Information



<p><b>Legend:</b> XX...X Product code or customer-specific information Y Year code (last digit of calendar year) YY Year code (last 2 digits of calendar year) WW Week code (week of January 1 is week '01') NNN Alphanumeric traceability code  Pb-free JEDEC® designator for Matte Tin (Sn) * This package is Pb-free. The Pb-free JEDEC designator () can be found on the outer packaging for this package.</p> <p>●, ▲, ▼ Pin one index is identified by a dot, delta up, or delta down (triangle mark).</p>
<p><b>Note:</b> In the event the full Microchip part number cannot be marked on one line, it will be carried over to the next line, thus limiting the number of available characters for customer-specific information. Package may or may not include the corporate logo.</p> <p>Underbar (<math>\bar{\quad}</math>) and/or Overbar (<math>\bar{\quad}</math>) symbol may not be to scale.</p>

**TITLE**

20 LEAD SOICW PACKAGE OUTLINE & RECOMMENDED LAND PATTERN

DRAWING #	SOICW-20LD-PL-1	UNIT	INCH [MM]
-----------	-----------------	------	-----------

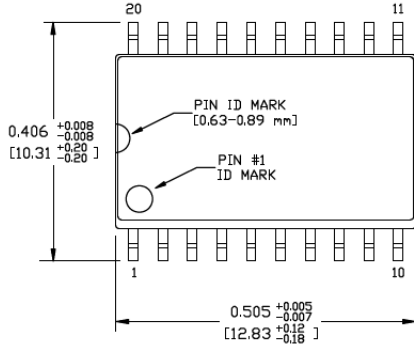

**TOP VIEW**

NOTE: 1, 2

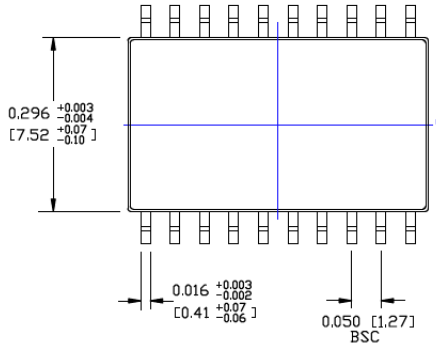

**BOTTOM VIEW**

NOTE: 1, 2

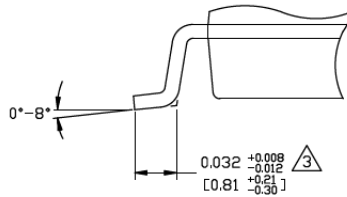

**DETAIL "A"**

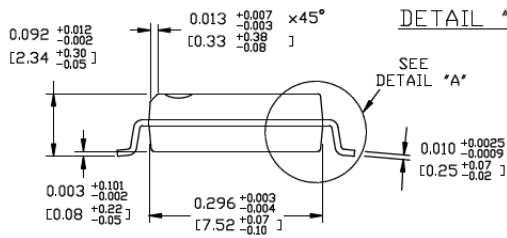

**END VIEW**

NOTE: 1, 2, 3

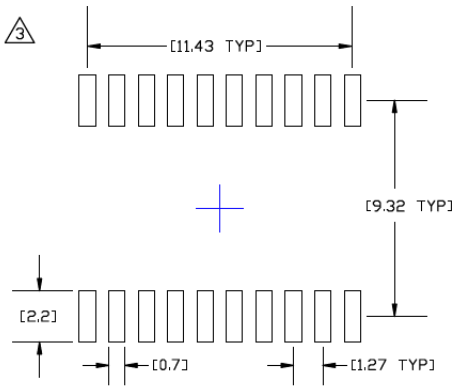

**RECOMMENDED LAND PATTERN**

**NOTES:**

1. DIMENSIONS ARE IN INCHES[MM].
2. CONTROLLING DIMENSION: INCHES.
3. DIMENSION DOES NOT INCLUDE MOLD FLASH OR PROTRUSIONS, EITHER OF WHICH SHALL NOT EXCEED 0.006[0.15] PER SIDE.

Note: For the most current package drawings, please see the Microchip Packaging Specification located at <http://www.microchip.com/packageing>.

# SY100EL29V

---

NOTES:



## APPENDIX A: REVISION HISTORY

### Revision A (August 2019)

- Converted Micrel document SY100EL29V to Microchip data sheet DS20006241A.
- Minor text changes throughout.

# SY100EL29V

---

NOTES:

## PRODUCT IDENTIFICATION SYSTEM

To order or obtain information, e.g., on pricing or delivery, contact your local Microchip representative or sales office.

<u>PART NO.</u>	<u>-XX</u>	<u>X</u>	<u>X</u>	<u>-XX</u>	<b>Examples:</b>
Device	Supply Voltage Range	Package	Temperature Range	Special Processing	
<b>Device:</b>	SY100EL29: Dual Differential Data and Clock D Flip-Flop with Set and Reset				a) SY100EL29VZG: SY100EL29, 3.3V/5V, -40°C to +85°C, 20-Lead SOIC, 38/Tube b) SY100EL29VZG-TR: SY100EL29, 3.3V/5V, -40°C to +85°C, 20-Lead SOIC, 1,000/Reel  <b>Note 1:</b> Tape and Reel identifier only appears in the catalog part number description. This identifier is used for ordering purposes and is not printed on the device package. Check with your Microchip Sales Office for package availability with the Tape and Reel option.
<b>Supply Voltage Range:</b>	V	=	3.3/5V		
<b>Package:</b>	Z	=	20-Lead SOIC (Pb-Free NiPdAu)		
<b>Temperature Range:</b>	G	=	-40°C to +85°C		
<b>Special Processing:</b>	<blank>	=	38/Tube		
	TR	=	1,000/Reel		

# SY100EL29V

---

NOTES:

---

---

**Note the following details of the code protection feature on Microchip devices:**

- Microchip products meet the specification contained in their particular Microchip Data Sheet.
- Microchip believes that its family of products is one of the most secure families of its kind on the market today, when used in the intended manner and under normal conditions.
- There are dishonest and possibly illegal methods used to breach the code protection feature. All of these methods, to our knowledge, require using the Microchip products in a manner outside the operating specifications contained in Microchip's Data Sheets. Most likely, the person doing so is engaged in theft of intellectual property.
- Microchip is willing to work with the customer who is concerned about the integrity of their code.
- Neither Microchip nor any other semiconductor manufacturer can guarantee the security of their code. Code protection does not mean that we are guaranteeing the product as “unbreakable.”

Code protection is constantly evolving. We at Microchip are committed to continuously improving the code protection features of our products. Attempts to break Microchip's code protection feature may be a violation of the Digital Millennium Copyright Act. If such acts allow unauthorized access to your software or other copyrighted work, you may have a right to sue for relief under that Act.

---

Information contained in this publication regarding device applications and the like is provided only for your convenience and may be superseded by updates. It is your responsibility to ensure that your application meets with your specifications. MICROCHIP MAKES NO REPRESENTATIONS OR WARRANTIES OF ANY KIND WHETHER EXPRESS OR IMPLIED, WRITTEN OR ORAL, STATUTORY OR OTHERWISE, RELATED TO THE INFORMATION, INCLUDING BUT NOT LIMITED TO ITS CONDITION, QUALITY, PERFORMANCE, MERCHANTABILITY OR FITNESS FOR PURPOSE. Microchip disclaims all liability arising from this information and its use. Use of Microchip devices in life support and/or safety applications is entirely at the buyer's risk, and the buyer agrees to defend, indemnify and hold harmless Microchip from any and all damages, claims, suits, or expenses resulting from such use. No licenses are conveyed, implicitly or otherwise, under any Microchip intellectual property rights unless otherwise stated.

### Trademarks

The Microchip name and logo, the Microchip logo, Adaptec, AnyRate, AVR, AVR logo, AVR Freaks, BesTime, BitCloud, chipKIT, chipKIT logo, CryptoMemory, CryptoRF, dsPIC, FlashFlex, flexPWR, HELDO, IGLOO, JukeBlox, KeeLoq, Klear, LANCheck, LinkMD, maXStylus, maXTouch, MediaLB, megaAVR, Microsemi, Microsemi logo, MOST, MOST logo, MPLAB, OptoLyzer, PackeTime, PIC, picoPower, PICSTART, PIC32 logo, PolarFire, Prochip Designer, QTouch, SAM-BA, SenGenuity, SpyNIC, SST, SST Logo, SuperFlash, Symmetricom, SyncServer, Tachyon, TempTrackr, TimeSource, tinyAVR, UNI/O, Vectron, and XMEGA are registered trademarks of Microchip Technology Incorporated in the U.S.A. and other countries.

APT, ClockWorks, The Embedded Control Solutions Company, EtherSynch, FlashTec, Hyper Speed Control, HyperLight Load, IntelliMOS, Libero, motorBench, mTouch, Powermite 3, Precision Edge, ProASIC, ProASIC Plus, ProASIC Plus logo, Quiet-Wire, SmartFusion, SyncWorld, Temux, TimeCesium, TimeHub, TimePictra, TimeProvider, Vite, WinPath, and ZL are registered trademarks of Microchip Technology Incorporated in the U.S.A.

Adjacent Key Suppression, AKS, Analog-for-the-Digital Age, Any Capacitor, AnyIn, AnyOut, BlueSky, BodyCom, CodeGuard, CryptoAuthentication, CryptoAutomotive, CryptoCompanion, CryptoController, dsPICDEM, dsPICDEM.net, Dynamic Average Matching, DAM, ECAN, EtherGREEN, In-Circuit Serial Programming, ICSP, INICnet, Inter-Chip Connectivity, JitterBlocker, KlearNet, KlearNet logo, memBrain, Mindi, MiWi, MPASM, MPF, MPLAB Certified logo, MPLIB, MPLINK, MultiTRAK, NetDetach, Omniscient Code Generation, PICDEM, PICDEM.net, PICKit, PICtail, PowerSmart, PureSilicon, QMatrix, REAL ICE, Ripple Blocker, SAM-ICE, Serial Quad I/O, SMART-I.S., SQI, SuperSwitcher, SuperSwitcher II, Total Endurance, TSHARC, USBCheck, VariSense, ViewSpan, WiperLock, Wireless DNA, and ZENA are trademarks of Microchip Technology Incorporated in the U.S.A. and other countries.

SQTP is a service mark of Microchip Technology Incorporated in the U.S.A.

The Adaptec logo, Frequency on Demand, Silicon Storage Technology, and Symmcom are registered trademarks of Microchip Technology Inc. in other countries.

GestIC is a registered trademark of Microchip Technology Germany II GmbH & Co. KG, a subsidiary of Microchip Technology Inc., in other countries.

All other trademarks mentioned herein are property of their respective companies.

© 2019, Microchip Technology Incorporated, All Rights Reserved.

ISBN: 978-1-5224-4960-7

For information regarding Microchip's Quality Management Systems, please visit [www.microchip.com/quality](http://www.microchip.com/quality).



# MICROCHIP

## Worldwide Sales and Service

### AMERICAS

**Corporate Office**  
2355 West Chandler Blvd.  
Chandler, AZ 85224-6199  
Tel: 480-792-7200  
Fax: 480-792-7277  
Technical Support:  
<http://www.microchip.com/support>  
Web Address:  
[www.microchip.com](http://www.microchip.com)

#### Atlanta

Duluth, GA  
Tel: 678-957-9614  
Fax: 678-957-1455

#### Austin, TX

Tel: 512-257-3370

#### Boston

Westborough, MA  
Tel: 774-760-0087  
Fax: 774-760-0088

#### Chicago

Itasca, IL  
Tel: 630-285-0071  
Fax: 630-285-0075

#### Dallas

Addison, TX  
Tel: 972-818-7423  
Fax: 972-818-2924

#### Detroit

Novi, MI  
Tel: 248-848-4000

#### Houston, TX

Tel: 281-894-5983

#### Indianapolis

Noblesville, IN  
Tel: 317-773-8323  
Fax: 317-773-5453  
Tel: 317-536-2380

#### Los Angeles

Mission Viejo, CA  
Tel: 949-462-9523  
Fax: 949-462-9608  
Tel: 951-273-7800

#### Raleigh, NC

Tel: 919-844-7510

#### New York, NY

Tel: 631-435-6000

#### San Jose, CA

Tel: 408-735-9110  
Tel: 408-436-4270

#### Canada - Toronto

Tel: 905-695-1980  
Fax: 905-695-2078

### ASIA/PACIFIC

**Australia - Sydney**  
Tel: 61-2-9868-6733

**China - Beijing**  
Tel: 86-10-8569-7000

**China - Chengdu**  
Tel: 86-28-8665-5511

**China - Chongqing**  
Tel: 86-23-8980-9588

**China - Dongguan**  
Tel: 86-769-8702-9880

**China - Guangzhou**  
Tel: 86-20-8755-8029

**China - Hangzhou**  
Tel: 86-571-8792-8115

**China - Hong Kong SAR**  
Tel: 852-2943-5100

**China - Nanjing**  
Tel: 86-25-8473-2460

**China - Qingdao**  
Tel: 86-532-8502-7355

**China - Shanghai**  
Tel: 86-21-3326-8000

**China - Shenyang**  
Tel: 86-24-2334-2829

**China - Shenzhen**  
Tel: 86-755-8864-2200

**China - Suzhou**  
Tel: 86-186-6233-1526

**China - Wuhan**  
Tel: 86-27-5980-5300

**China - Xian**  
Tel: 86-29-8833-7252

**China - Xiamen**  
Tel: 86-592-2388138

**China - Zhuhai**  
Tel: 86-756-3210040

### ASIA/PACIFIC

**India - Bangalore**  
Tel: 91-80-3090-4444

**India - New Delhi**  
Tel: 91-11-4160-8631

**India - Pune**  
Tel: 91-20-4121-0141

**Japan - Osaka**  
Tel: 81-6-6152-7160

**Japan - Tokyo**  
Tel: 81-3-6880-3770

**Korea - Daegu**  
Tel: 82-53-744-4301

**Korea - Seoul**  
Tel: 82-2-554-7200

**Malaysia - Kuala Lumpur**  
Tel: 60-3-7651-7906

**Malaysia - Penang**  
Tel: 60-4-227-8870

**Philippines - Manila**  
Tel: 63-2-634-9065

**Singapore**  
Tel: 65-6334-8870

**Taiwan - Hsin Chu**  
Tel: 886-3-577-8366

**Taiwan - Kaohsiung**  
Tel: 886-7-213-7830

**Taiwan - Taipei**  
Tel: 886-2-2508-8600

**Thailand - Bangkok**  
Tel: 66-2-694-1351

**Vietnam - Ho Chi Minh**  
Tel: 84-28-5448-2100

### EUROPE

**Austria - Wels**  
Tel: 43-7242-2244-39  
Fax: 43-7242-2244-393

**Denmark - Copenhagen**  
Tel: 45-4450-2828  
Fax: 45-4485-2829

**Finland - Espoo**  
Tel: 358-9-4520-820

**France - Paris**  
Tel: 33-1-69-53-63-20  
Fax: 33-1-69-30-90-79

**Germany - Garching**  
Tel: 49-8931-9700

**Germany - Haan**  
Tel: 49-2129-3766400

**Germany - Heilbronn**  
Tel: 49-7131-72400

**Germany - Karlsruhe**  
Tel: 49-721-625370

**Germany - Munich**  
Tel: 49-89-627-144-0  
Fax: 49-89-627-144-44

**Germany - Rosenheim**  
Tel: 49-8031-354-560

**Israel - Ra'anana**  
Tel: 972-9-744-7705

**Italy - Milan**  
Tel: 39-0331-742611  
Fax: 39-0331-466781

**Italy - Padova**  
Tel: 39-049-7625286

**Netherlands - Drunen**  
Tel: 31-416-690399  
Fax: 31-416-690340

**Norway - Trondheim**  
Tel: 47-7288-4388

**Poland - Warsaw**  
Tel: 48-22-3325737

**Romania - Bucharest**  
Tel: 40-21-407-87-50

**Spain - Madrid**  
Tel: 34-91-708-08-90  
Fax: 34-91-708-08-91

**Sweden - Gothenberg**  
Tel: 46-31-704-60-40

**Sweden - Stockholm**  
Tel: 46-8-5090-4654

**UK - Wokingham**  
Tel: 44-118-921-5800  
Fax: 44-118-921-5820

# Mouser Electronics

Authorized Distributor

Click to View Pricing, Inventory, Delivery & Lifecycle Information:

[Microchip:](#)

[SY100EL29VZG](#) [SY100EL29VZG TR](#) [SY100EL29VZG-TR](#)