

APT60D40BG Fast Soft Recovery Rectifier Diode

Product Overview

The APT60D40BG is a 400 V, 60 A Fast Soft Recovery Rectifier Si diode in a TO-247 package.

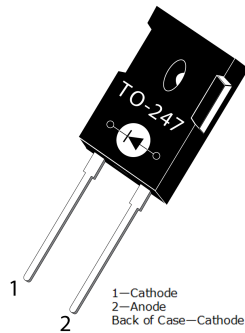

Features

The following are key features of the APT60D40BG device:

- Fast recovery times
- Soft recovery characteristics
- Low forward voltage
- Low leakage current
- RoHS compliant

Benefits

The following are benefits of the APT60D40BG device:

- Low switching losses
- Low noise (EMI) switching
- Cooler operation
- Higher reliability systems
- Increased system power density

Applications

The APT60D40BG device is designed for the following applications:

- Power factor correction (PFC)
- Anti-parallel diode
 - Switchmode power supply
 - Inverters
- Freewheeling diode
 - Motor controllers
 - Inverters/converters
- Snubber diode

Device Specifications

This section shows the specifications of the APT60D40BG device.

Absolute Maximum Ratings

The following table shows the absolute maximum ratings of the APT60D40BG device. $T_C = 25\text{ }^\circ\text{C}$ unless otherwise specified.

Table 1 • Absolute Maximum Ratings

Symbol	Parameter	Ratings	Unit
V_R	Maximum DC reverse voltage	400	V
V_{RRM}	Maximum peak repetitive reverse voltage		
V_{RWM}	Maximum working peak reverse voltage		
$I_{F(AV)}$	Maximum average forward current ($T_C = 140\text{ }^\circ\text{C}$, duty cycle = 0.5)	60	A
I_{FSM}	Non-repetitive forward surge current ($T_J = 45\text{ }^\circ\text{C}$, 8.3 ms)	600	

The following table shows the thermal and mechanical characteristics of the APT60D40BG device.

Table 2 • Thermal and Mechanical Characteristics

Symbol	Characteristic/Test Conditions	Min	Typ	Max	Unit
$R_{\theta JC}$	Junction-to-case thermal resistance			0.34	$^\circ\text{C}/\text{W}$
$R_{\theta JA}$	Junction-to-ambient thermal resistance			40	
T_J, T_{STG}	Operating and storage temperature range	-55		175	$^\circ\text{C}$
T_L	Lead temperature for 10 seconds			300	
Wt	Package weight		0.22		oz
			6.2		g
	Mounting torque, 6-32 or M3 screw			10	lbf-in
				1.1	N-m

Electrical Performance

The following table shows the static characteristics of the APT60D40BG device. $T_J = 25\text{ }^\circ\text{C}$ unless otherwise specified.

Table 3 • Static Characteristics

Symbol	Characteristic	Test Conditions	Min	Typ	Max	Unit
V_F	Forward voltage	$I_F = 60\text{ A}$		1.3	1.5	V
		$I_F = 120\text{ A}$		1.6		
		$I_F = 60\text{ A}, T_J = 125\text{ }^\circ\text{C}$		1.2		
I_{RM}	Maximum reverse leakage current	$V_R = V_R\text{ Rated}$			250	μA
		$V_R = V_R\text{ Rated}, T_J = 125\text{ }^\circ\text{C}$			500	
C_J	Junction capacitance	$V_R = 200\text{ V}$		120		pF

The following table shows the dynamic characteristics of the APT60D40BG device.

Table 4 • Dynamic Characteristics

Symbol	Characteristic	Test Conditions	Min	Typ	Max	Unit
t_{rr}	Reverse recovery time	$I_F = 1\text{ A}, di_F/dt = -100\text{ A}/\mu\text{s}$ $V_R = 30\text{ V}$		30		ns
t_{rr}	Reverse recovery time	$I_F = 60\text{ A}, di_F/dt = -200\text{ A}/\mu\text{s}$ $V_R = 266\text{ V}$		37		
Q_{rr}	Reverse recovery charge			80		
I_{RRM}	Maximum reverse recovery current			4		A
t_{rr}	Reverse recovery time	$I_F = 60\text{ A}, di_F/dt = -200\text{ A}/\mu\text{s}$ $V_R = 266\text{ V}, T_J = 125\text{ }^\circ\text{C}$		110		ns
Q_{rr}	Reverse recovery charge			540		nC
I_{RRM}	Maximum reverse recovery current			10		A
t_{rr}	Reverse recovery time	$I_F = 60\text{ A}, di_F/dt = -800\text{ A}/\mu\text{s}$ $V_R = 266\text{ V}, T_J = 125\text{ }^\circ\text{C}$		65		ns
Q_{rr}	Reverse recovery charge			1050		nC
I_{RRM}	Maximum reverse recovery current			27		

Typical Performance Curves

This section shows the typical performance curves of the APT60D40BG device.

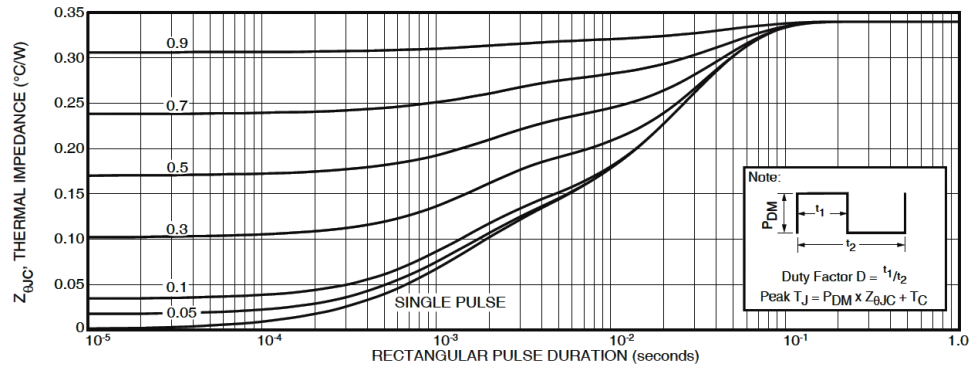

Figure 1 • Maximum Transient Thermal Impedance

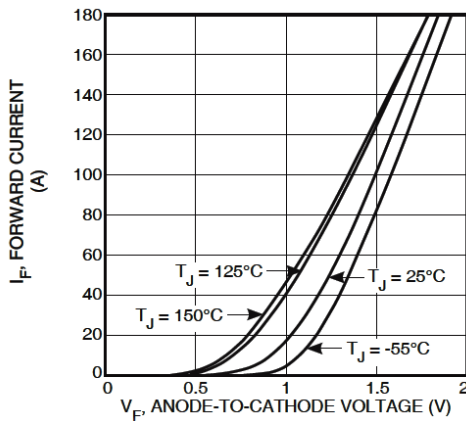

Figure 2 • Forward Current vs. Forward Voltage

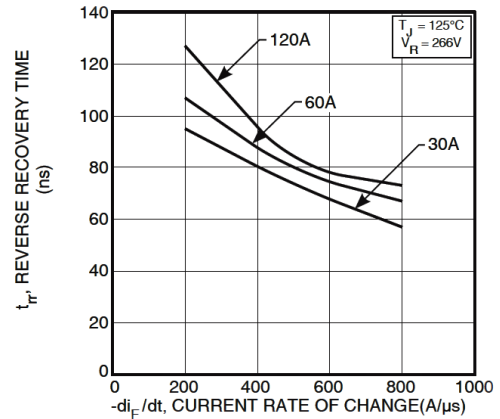

Figure 3 • Reverse Recovery Time vs. Current Rate of Change

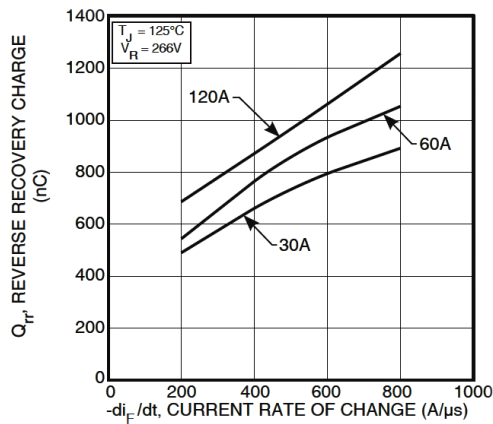

Figure 4 • Reverse Recovery Charge vs. Current Rate of Change

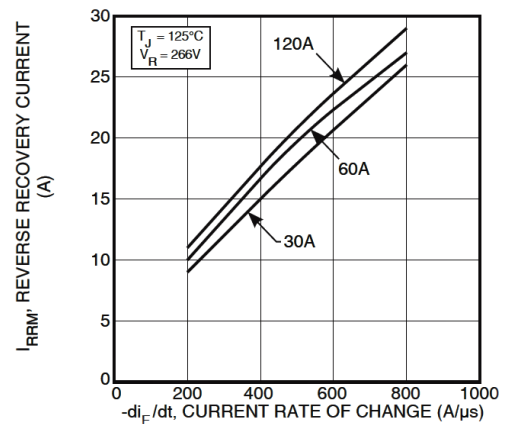

Figure 5 • Reverse Recovery Current vs. Current Rate of Change

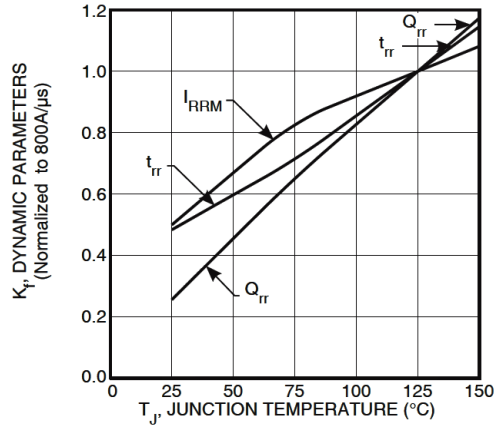

Figure 6 • Dynamic Parameters vs. Junction Temperature

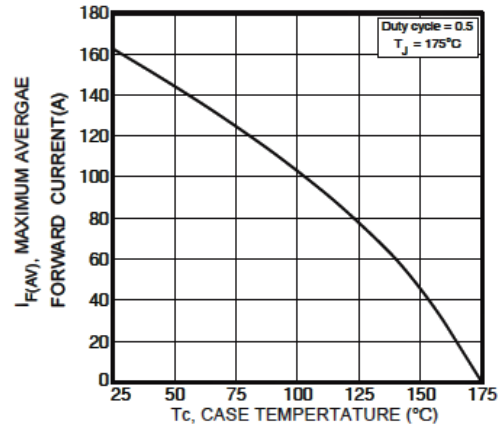

Figure 7 • Maximum Average Forward Current vs. Case Temperature

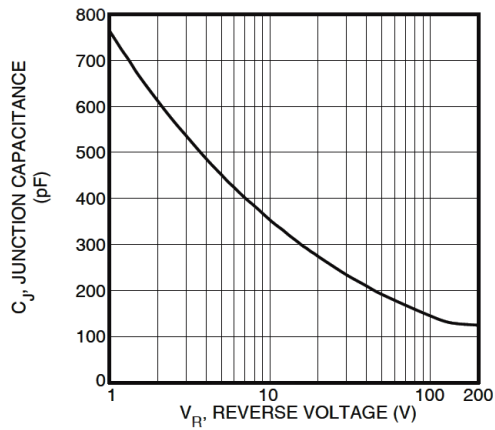

Figure 8 • Junction Capacitance vs. Reverse Voltage

Reverse Recovery Overview

The figure illustrates the diode test circuit of the APT60D40BG device.

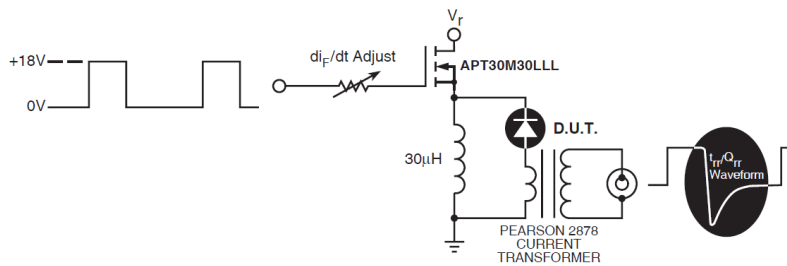

Figure 9 • Diode Test Circuit

The following figure illustrates the diode reverse recovery waveform and definitions of the APT60D40BG device.

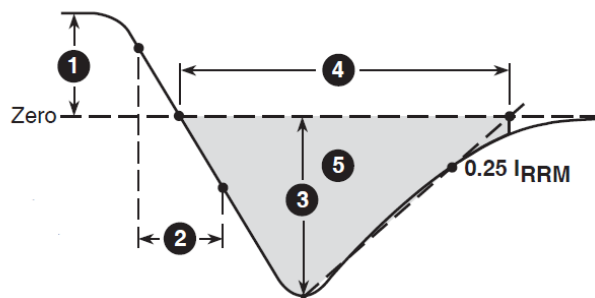

Figure 10 • Diode Reverse Recovery Waveform and Definitions

1. I_F — Forward conduction current.
2. di_F/dt — Rate of diode current change through zero crossing.
3. I_{RRM} — Maximum reverse recovery current.
4. t_{rr} — Reverse recovery time, measured from zero crossing where diode current goes from positive to negative, to the point at which the straight line through I_{RRM} and $0.25 \cdot I_{RRM}$ passes through zero.
5. Q_{rr} — Area under the curve defined by I_{RRM} and t_{rr} .

Package Specification

This section shows the package specification of the APT60D40BG device.

Package Outline Drawing

The following figure illustrates the TO-247 package outline of the APT60D40BG device.

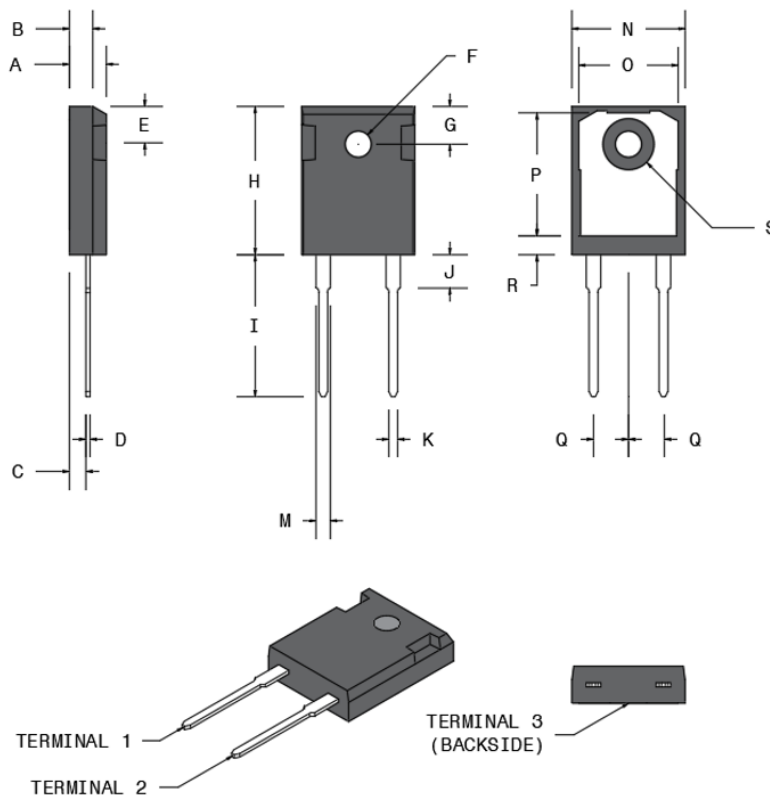

Figure 11 • Package Outline Drawing

The following table shows the TO-247 dimensions and should be used in conjunction with the package outline drawing.

Table 5 • TO-247 Dimensions

Symbol	Min	Max	Min	Max
	(mm)		(Inch)	
A	4.69	5.31	0.185	0.209
B	1.49	2.49	0.059	0.098
C	2.21	2.59	0.087	0.102
D	0.40	0.79	0.016	0.031
E	5.38	6.20	0.212	0.244

Symbol	Min	Max	Min	Max
	(mm)		(Inch)	
F	3.50	3.81	0.138	0.150
G	6.15 BSC	0.242 BSC		
H	20.80	21.46	0.819	0.845
I	19.81	20.32	0.780	0.800
J	4.00	4.50	0.157	0.177
K	1.01	1.40	0.040	0.055
L	2.87	3.12	0.113	0.123
M	1.65	2.13	0.065	0.084
N	15.49	16.26	0.610	0.640
O	13.50	14.50	0.531	0.571
P	16.50	17.50	0.650	0.689
Q	5.45 BSC	0.215 BSC		
R	2.00	2.75	0.079	0.108
S	7.10	7.50	0.280	0.295
TERMINAL 1	CATHODE			
TERMINAL 2	ANODE			
TERMINAL 3	CATHODE			

**Microsemi**

2355 W. Chandler Blvd.
 Chandler, AZ 85224 USA

Within the USA: +1 (480) 792-7200
 Fax: +1 (480) 792-7277

www.microsemi.com © 2020 Microsemi and its corporate affiliates. All rights reserved. Microsemi and the Microsemi logo are trademarks of Microsemi Corporation and its corporate affiliates. All other trademarks and service marks are the property of their respective owners.

Microsemi's product warranty is set forth in Microsemi's Sales Order Terms and Conditions. Information contained in this publication is provided for the sole purpose of designing with and using Microsemi products. Information regarding device applications and the like is provided only for your convenience and may be superseded by updates. Buyer shall not rely on any data and performance specifications or parameters provided by Microsemi. It is your responsibility to ensure that your application meets with your specifications. THIS INFORMATION IS PROVIDED "AS IS." MICROSEMI MAKES NO REPRESENTATIONS OR WARRANTIES OF ANY KIND WHETHER EXPRESS OR IMPLIED, WRITTEN OR ORAL, STATUTORY OR OTHERWISE, RELATED TO THE INFORMATION, INCLUDING BUT NOT LIMITED TO ITS CONDITION, QUALITY, PERFORMANCE, NON-INFRINGEMENT, MERCHANTABILITY OR FITNESS FOR A PARTICULAR PURPOSE. IN NO EVENT WILL MICROSEMI BE LIABLE FOR ANY INDIRECT, SPECIAL, PUNITIVE, INCIDENTAL OR CONSEQUENTIAL LOSS, DAMAGE, COST OR EXPENSE WHATSOEVER RELATED TO THIS INFORMATION OR ITS USE, HOWEVER CAUSED, EVEN IF MICROSEMI HAS BEEN ADVISED OF THE POSSIBILITY OR THE DAMAGES ARE FORESEEABLE. TO THE FULLEST EXTENT ALLOWED BY LAW, MICROSEMI'S TOTAL LIABILITY ON ALL CLAIMS IN RELATED TO THIS INFORMATION OR ITS USE WILL NOT EXCEED THE AMOUNT OF FEES, IF ANY, YOU PAID DIRECTLY TO MICROSEMI FOR THIS INFORMATION. Use of Microsemi devices in life support, mission-critical equipment or applications, and/or safety applications is entirely at the buyer's risk, and the buyer agrees to defend and indemnify Microsemi from any and all damages, claims, suits, or expenses resulting from such use. No licenses are conveyed, implicitly or otherwise, under any Microsemi intellectual property rights unless otherwise stated.

Microsemi Corporation, a subsidiary of Microchip Technology Inc. (Nasdaq: MCHP), and its corporate affiliates are leading providers of smart, connected and secure embedded control solutions. Their easy-to-use development tools and comprehensive product portfolio enable customers to create optimal designs which reduce risk while lowering total system cost and time to market. These solutions serve more than 120,000 customers across the industrial, automotive, consumer, aerospace and defense, communications and computing markets. Headquartered in Chandler, Arizona, the company offers outstanding technical support along with dependable delivery and quality. Learn more at www.microsemi.com.

053-4001 | April 2020 | Released

Mouser Electronics

Authorized Distributor

Click to View Pricing, Inventory, Delivery & Lifecycle Information:

[Microchip:](#)

[APT60D40BG](#) [APT60D40SG](#)