

The documentation and process conversion measures necessary to comply with this document shall be completed by 28 April 2013.

INCH POUND

MIL-PRF-19500/317P  
 28 January 2013  
 SUPERSEDING  
 MIL-PRF-19500/317N  
 27 December 2010

PERFORMANCE SPECIFICATION SHEET

\* SEMICONDUCTOR DEVICE, TRANSISTOR, NPN, SILICON, SWITCHING,  
 TYPES 2N2369A, 2N3227, 2N4449, 2N2369AU, 2N3227U, 2N2369AUA, 2N3227UA, 2N2369AUB,  
 2N2369AUBC, 2N2369AUBCN 2N3227UB, 2N3227UBC, 2N3227UBCN, 2N4449U, 2N4449UA, 2N4449UB,  
 2N4449UBC, AND 2N4449UBCN, JAN, JANTX, JANTXV, JANS, JANSM, JANSJ, JANSK, JANSN, JANSR, JANSF,  
 JANSJ, JANSK, JANSH, JANHCA, JANHCB, JANKCA, JANKCB, JANKCM, JANKCD, JANKCP, JANKCL, JANKCR,  
 JANKCF, JANKCG, AND JANKCH

This specification is approved for use by all Departments and Agencies of the Department of Defense.

The requirements for acquiring the product described herein shall consist of this specification sheet and MIL-PRF-19500.

1. SCOPE

1.1 Scope. This specification covers the performance requirements for NPN, silicon, high speed switching transistors (including dual devices). Four levels of product assurance are provided for each device type as specified in MIL-PRF-19500, and two levels of product assurance are provided for each unencapsulated device type. Provisions for radiation hardness assurance (RHA) to four radiation levels is provided for JANTXV, JANS, JANHC, and JANKC product assurance levels. RHA level designators "M", "D", "P", "L", "R", "F", "G", and "H" are appended to the device prefix to identify devices, which have passed RHA requirements.

\* 1.2 Physical dimensions. See figure 1 (TO-18) for 2N2369A and 2N3227, figure 2 (TO-46) for 2N4449, figure 3 (UB, UBC, and UBCN), figure 4 (UA version), figure 5 (U version dual devices), and figures 6 and 7 (JANC die).

\* 1.3 Maximum ratings. Unless otherwise specified,  $T_A = +25^\circ\text{C}$ .

Types	$P_T T_A = +25^\circ\text{C}$	$P_T T_C = +125^\circ\text{C}$	$P_T T_{SP} = +125^\circ\text{C}$ (1)	$V_{CBO}$	$V_{EBO}$	$V_{CEO}$	$V_{CES}$	$T_J$ and $T_{STG}$
	W	W	W	V dc	V dc	V dc	V dc	$^\circ\text{C}$
2N2369A, UA, UB, UBC, UBCN	0.36 (2)	0.36 (3)(4)	0.36 (3)	40	4.5	15	40	-65
2N4449, UA, UB, UBC, UBCN	0.36 (2)	0.36 (3)(4)	0.36 (3)	40	4.5	15	40	to
2N3227, UA, UB, UBC, UBCN	0.36 (2)	0.36 (3)(4)	0.36 (3)	40	6.0	20	40	+200
2N2369AU	0.5 (5)			40	4.5	15	40	
2N4449U	0.5 (5)			40	4.5	15	40	
2N3227U	0.5 (5)			40	6.0	20	40	

See notes at end of table.

\* Comments, suggestions, or questions on this document should be addressed to DLA Land and Maritime, ATTN: VAC, P.O. Box 3990, Columbus, OH 43218-3990, or emailed to [Semiconductor@dla.mil](mailto:Semiconductor@dla.mil). Since contact information can change, you may want to verify the currency of this address information using the ASSIST Online database at <https://assist.dla.mil>.

MIL-PRF-19500/317P

\* 1.3 Maximum ratings. Unless otherwise specified,  $T_A = +25^\circ\text{C}$ . - Continued.

Types	$R_{\theta JA}$	$R_{\theta JC}$	$R_{\theta JSP}$
	$^\circ\text{C/W}$	$^\circ\text{C/W}$	$^\circ\text{C/W}$
2N2369A	400	150	
2N4449	400	150	
2N3227	400	150	
2N2369AUA, UB, UBC, UBCN	486		210
2N4449UA, UB, UBC, UBCN	486		210
2N3227UA, UB, UBC, UBCN	486		210
2N2369AU	350 (6)		290 (7)
2N4449U	350 (6)		290 (7)
2N3227U	350 (6)		290 (7)

- \* (1) Applicable for UA, UB, UBC, UBCN and U packages.
- (2) For TO-18 and TO-46 packages derate linearly 2.06 mW/ $^\circ\text{C}$  above  $T_A = +25^\circ\text{C}$ .
- (3) Derate linearly 4.8 mW/ $^\circ\text{C}$  above  $T_C = +125^\circ\text{C}$ . See figures 8, 9, 10, 11, and 12.
- (4) Power dissipation limited to 360 mW per chip regardless of thermal resistance.
- \* (5) For UA, UB, UBC, and UBCN packages mounted on FR-4 PCB (1 Oz. Cu) with contacts 20 mils larger than package pads. See figure 13.
- (6) One side only, derate linearly 2.857 mW/ $^\circ\text{C}$  above  $T_{SP} = +25^\circ\text{C}$ .
- (7) Derate linearly 3.44 mW/ $^\circ\text{C}$  above  $T_A = +54.5^\circ\text{C}$ . See figure 13.

1.4 Primary electrical characteristics. Unless otherwise specified,  $T_A = +25^\circ\text{C}$ .

Type (1)	$h_{FE2}$ (2) $V_{CE} = 0.4 \text{ V dc}$ $I_C = 30 \text{ mA dc}$		$h_{FE4}$ (2) $V_{CE} = 1.0 \text{ V dc}$ $I_C = 100 \text{ mA dc}$		$ h_{FE} $ $V_{CE} = 10 \text{ V dc}$ $I_C = 10 \text{ mA dc}$ $f = 100 \text{ MHz}$		$V_{CE(sat)1}$ $I_C = 10 \text{ mA dc}$ $I_B = 1 \text{ mA dc}$	$t_{on}$ $I_C = 10 \text{ mA dc}$ $I_{B1} = 3 \text{ mA dc}$ $I_{B2} = -1.5 \text{ mA dc}$	$t_{off}$ $I_C = 10 \text{ mA dc}$ $I_{B1} = 3 \text{ mA dc}$ $I_{B2} = -1.5 \text{ mA dc}$	$t_s$ $I_C = 10 \text{ mA dc}$ $I_{B1} = I_{B2} = 10 \text{ mA dc}$
	Min	Max	Min	Max	Min	Max	$\sqrt{\text{dc Max}}$	ns	ns	ns
2N2369A	30	120	20	120	5.0	10	0.20	12	18	13
2N3227	40	250	30	150	5.0	10	0.20	12	25	18
2N4449	30	120	20	120	5.0	10	0.20	12	18	13

- (1) Electrical characteristics for the A, AU, AUBC, U, UA, UB, and UBC suffix devices are identical to the corresponding non-suffix device.
- (2) Pulsed (see 4.5.1).

Ltr.	Dimensions				Notes
	Inches		Millimeters		
	Min	Max	Min	Max	
CD	.178	.195	4.52	4.95	
CH	.170	.210	4.32	5.33	
HD	.209	.230	5.31	5.84	
LC	.100 TP		2.54 TP		6
LD	.016	.021	0.41	0.53	7,8
LL	.500	.750	12.70	19.05	7,8,13
LU	.016	.019	0.41	0.48	7,8
L <sub>1</sub>		.050		1.27	7,8
L <sub>2</sub>	.250		6.35		7,8
P	.100		2.54		5
Q		.030		0.76	5
TL	.028	.048	0.71	1.22	3,4
TW	.036	.046	0.91	1.17	3
r		.010		0.25	10
$\alpha$	45° TP		45° TP		6

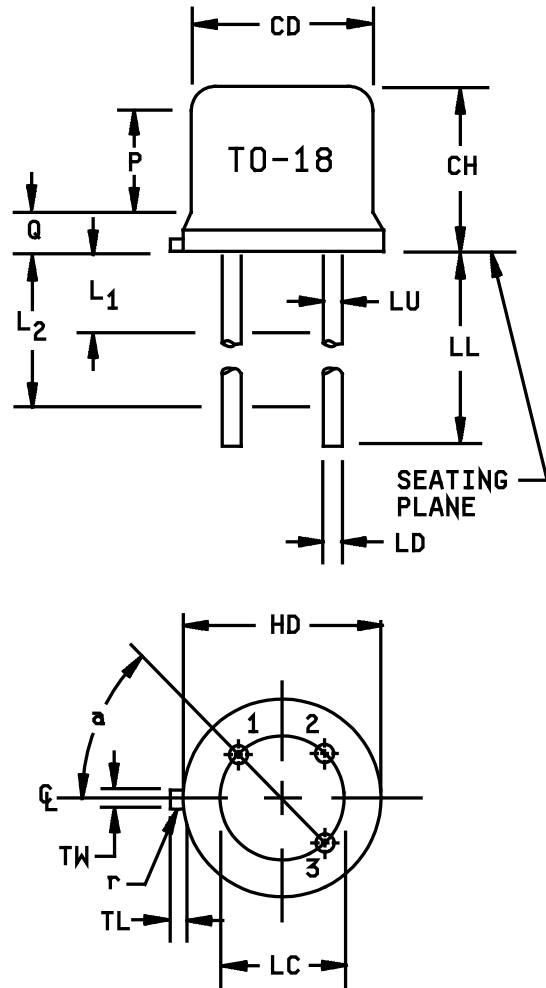

NOTES:

1. Dimension are in inches.
2. Millimeters are given for general information only.
3. Beyond r (radius) maximum, TH shall be held for a minimum length of .011 (0.28 mm).
4. Dimension TL measured from maximum HD.
5. Body contour optional within zone defined by HD, CD, and Q.
6. Leads at gauge plane .054 +.001 -.000 inch (1.37 +0.03 -0.00 mm) below seating plane shall be within .007 inch (0.18 mm) radius of true position (TP) at maximum material condition (MMC) relative to tab at MMC.
7. Dimension LU applies between L<sub>1</sub> and L<sub>2</sub>. Dimension LD applies between L<sub>2</sub> and LL minimum. Diameter is uncontrolled in L<sub>1</sub> and beyond LL minimum.
8. All three leads.
9. The collector shall be internally connected to the case.
10. Dimension r (radius) applies to both inside corners of tab.
11. In accordance with ASME Y14.5M, diameters are equivalent to  $\phi$ x symbology.
12. Lead 1 = emitter, lead 2 = base, lead 3 = collector.

FIGURE 1. Physical dimensions TO-18 2N2369A and 2N3227.

Ltr.	Dimensions				Notes
	Inches		Millimeters		
	Min	Max	Min	Max	
CD	.178	.195	4.52	4.95	
CH	.065	.085	1.65	2.16	
HD	.209	.230	5.31	5.84	
LC	.100 TP		2.54 TP		5
LD	.016	.021	0.41	0.53	
LL	.500	1.750	12.70	44.45	6
LU	.016	.019	0.41	0.48	6
L <sub>1</sub>		.050		1.27	6
L <sub>2</sub>	.250		6.35		6
Q		.040		1.02	3
TL	.028	.048	0.71	1.22	8
TW	.036	.046	0.91	1.17	4
r		.010		0.25	9
$\alpha$	45° TP		45° TP		5

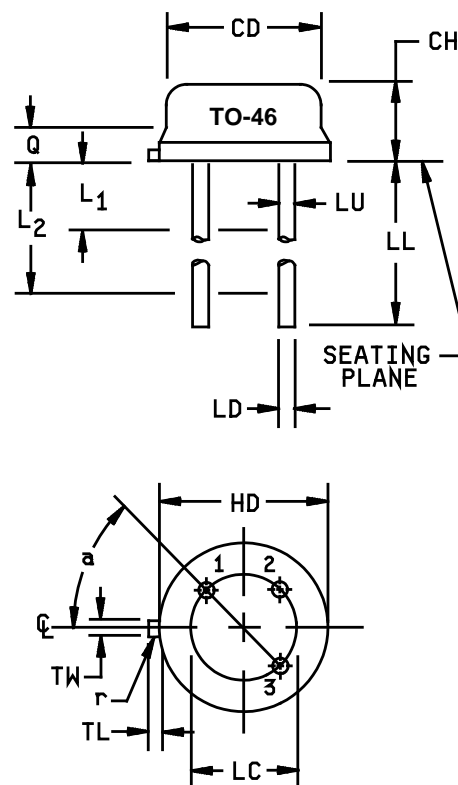

## NOTES:

1. Dimensions are in inches.
2. Millimeters are given for general information only.
3. Symbol TL is measured from HD maximum.
4. Details of outline in this zone are optional.
5. Leads at gauge plane .054 inch (1.37 mm) +.001 inch (0.03 mm) -.000 inch (0.00 mm) below seating plane shall be within .007 inch (0.18 mm) radius of TP relative to tab. Device may be measured by direct methods or by gauge.
6. Symbol LU applies between L<sub>1</sub> and L<sub>2</sub>. Dimension LD applies between L<sub>2</sub> and LL minimum.
7. Lead number three is electrically connected to case.
8. Beyond r maximum, TW shall be held for a minimum length of .011 inch (0.28 mm).
9. Symbol r applied to both inside corners of tab.
10. In accordance with ASME Y14.5M, diameters are equivalent to  $\phi$ x symbology.
11. Lead 1 is emitter, lead 2 is base, and lead 3 is collector.

FIGURE 2. Physical dimensions - TO-46 (2N4449).

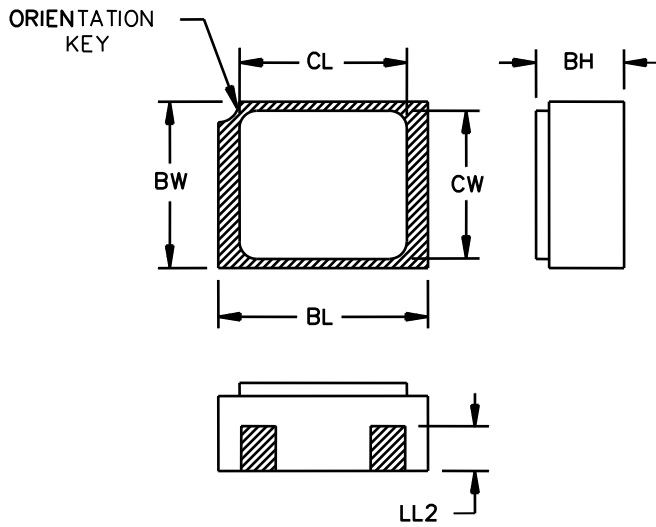

UBC,UBN,AND UBCN

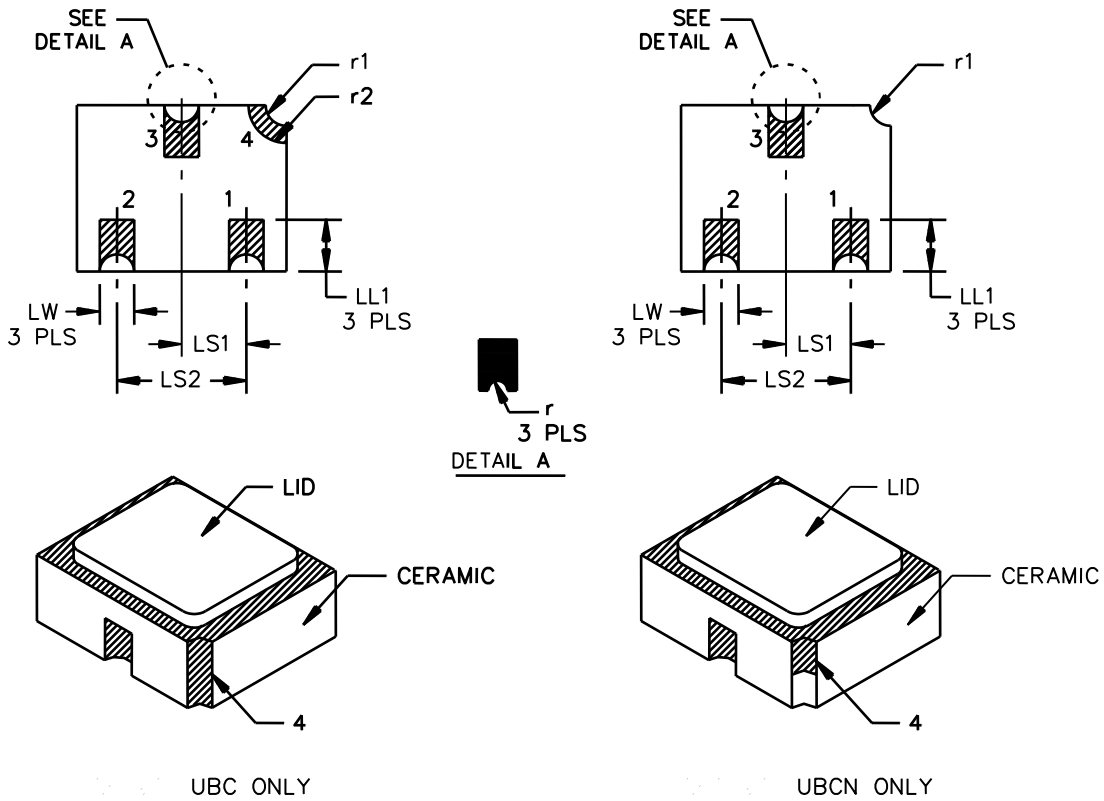

\* FIGURE 3. Physical dimensions, surface mount (UB, UBC, and UBCN versions, ceramic lid).

MIL-PRF-19500/317P

Symbol	Dimensions				Note
	Inches		Millimeters		
	Min	Max	Min	Max	
BL	.115	.128	2.92	3.25	
BW	.095	.108	2.41	2.74	
BH	.046	.056	1.17	1.42	UB only, 4
BH	.055	.069	1.40	1.75	UBC only, 5
BH	.055	.069	1.40	1.75	UBCN only, 6
CL		.128		3.25	
CW		.108		2.74	
LL1	.022	.038	0.56	0.97	3 places
LL2	.014		0.356		3 places
LS <sub>1</sub>	.035	.039	0.89	0.99	
LS <sub>2</sub>	.071	.079	1.80	2.01	
LW	.016	.024	0.41	0.61	
r		.008		0.20	6
r1		.012		0.30	8
r2		.022		0.56	UB and UBC only, 8

NOTES:

1. Dimensions are in inches.
2. Millimeters are given for general information only.
3. Hatched areas on package denote metallized areas.
4. UB only: Pad 1 = Base, Pad 2 = Emitter, Pad 3 = Collector, Pad 4 = connected to the lid braze ring.
5. UBC (ceramic lid) only: Pad 1 = Base, Pad 2 = Emitter, Pad 3 = Collector, Pad 4 = connected to the lid braze ring.
6. UBCN (ceramic lid) only: Pad 1 = Base, Pad 2 = Emitter, Pad 3 = Collector, Isolated lid with three pads only.
7. For design reference only.
8. In accordance with ASME Y14.5M, diameters are equivalent to  $\phi x$  symbology.

\* FIGURE 3. Physical dimensions, surface mount (UB, UBC, and UBCN versions) - Continued.

MIL-PRF-19500/317P

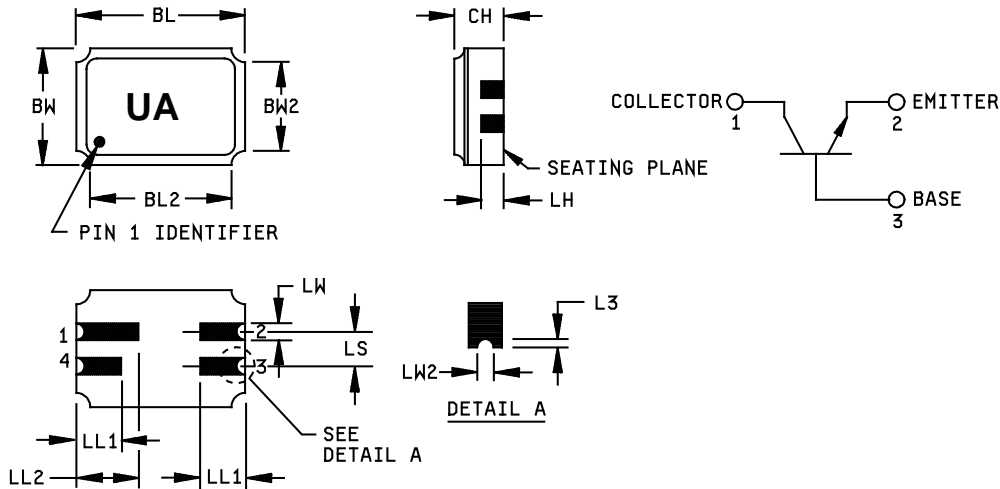

Ltr.	Dimensions			
	Inches		Millimeters	
	Min	Max	Min	Max
BL	.215	.225	5.46	5.71
BL2		.225		5.71
BW	.145	.155	3.68	3.93
BW <sub>2</sub>		.155		3.93
CH	.061	.075	1.55	1.90
* L3	.003		0.08	
LH	.029	.042	0.74	1.07
LL <sub>1</sub>	.032	.048	0.81	1.22
LL <sub>2</sub>	.072	.088	1.83	2.23
LS	.045	.055	1.14	1.39
LW	.022	.028	0.56	0.71
LW2	.006	.022	0.15	0.56

Pin number.	1	2	3	4
Transistor	Collector	Emitter	Base	N/C

NOTES:

1. Dimensions are in inches.
2. Millimeters are given for general information only.
3. Dimension CH controls the overall package thickness. When a window lid is used, dimension CH must increase by a minimum of .010 inch (0.254 mm) and a maximum of .040 inch (1.020 mm).
4. The corner shape (square, notch, radius) may vary at the manufacturer's option, from that shown on the drawing.
5. Dimensions LW2 minimum and L3 minimum and the appropriate castellation length define an unobstructed three-dimensional space traversing all of the ceramic layers in which a castellation was designed. (Castellations are required on the bottom two layers, optional on the top ceramic layer.) Dimension LW2 maximum and L3 maximum define the maximum width and depth of the castellation at any point on its surface. Measurement of these dimensions may be made prior to solder dipping.
6. The co-planarity deviation of all terminal contact points, as defined by the device seating plane, shall not exceed .006 inch (0.15mm) for solder dipped leadless chip carriers.
7. In accordance with ASME Y14.5M, diameters are equivalent to  $\phi$ x symbology.

\* FIGURE 4. Physical dimensions - surface mount (UA version, 2N2369AUA, 2N3227UA).

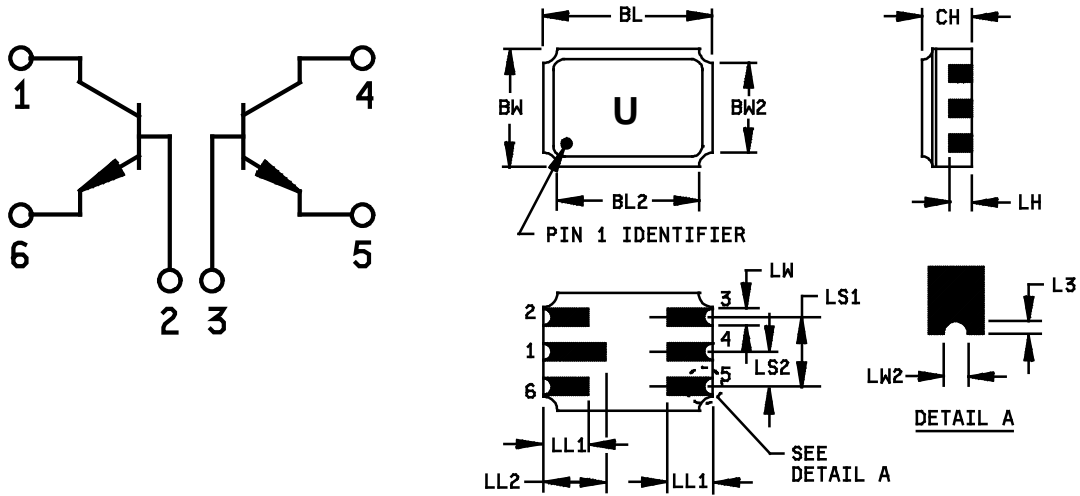

Ltr.	Dimensions			
	Inches		Millimeters	
	Min	Max	Min	Max
BL	.240	.250	6.10	6.35
BL <sub>2</sub>		.250		6.35
BW	.165	.175	4.19	4.44
BW <sub>2</sub>		.175		4.44
CH	.066	.080	1.68	2.03
L <sub>3</sub>	.003	.007	0.08	0.18
LH	.026	.039	0.66	0.99
LL <sub>1</sub>	.060	.070	1.52	1.78
LL <sub>2</sub>	.082	.098	2.08	2.49
LS <sub>1</sub>	.095	.105	2.41	2.67
LS <sub>2</sub>	.045	.055	1.14	1.39
LW	.022	.028	0.56	0.71
LW <sub>2</sub>	.006	.022	0.15	0.56

Pin number	1	2	3	4	5	6
Transistor	Collector no. 1	Base no. 1	Base no. 2	Collector no. 2	Emitter no. 2	Emitter no. 1

NOTES:

1. Dimensions are in inches.
2. Millimeters are given for general information only.
3. Dimension CH controls the overall package thickness. When a window lid is used, dimension CH must increase by a minimum of .010 inch (0.254 mm) and a maximum of .040 inch (1.020 mm).
4. The corner shape (square, notch, radius) may vary at the manufacturer's option, from that shown on the drawing.
5. Dimensions LW<sub>2</sub> minimum and L<sub>3</sub> minimum and the appropriate castellation length define an unobstructed three-dimensional space traversing all of the ceramic layers in which a castellation was designed. (Castellations are required on the bottom two layers, optional on the top ceramic layer.) Dimension LW<sub>2</sub> maximum and L<sub>3</sub> maximum define the maximum width and depth of the castellation at any point on its surface. Measurement of these dimensions may be made prior to solder dipping.
6. The co-planarity deviation of all terminal contact points, as defined by the device seating plane, shall not exceed .006 inch (0.15mm) for solder dipped leadless chip carriers.
7. In accordance with ASME Y14.5M, diameters are equivalent to  $\phi x$  symbology.

FIGURE 5. Physical dimensions - surface mount (dual transistors, U version only, 2N2369AU, 2N3227U).



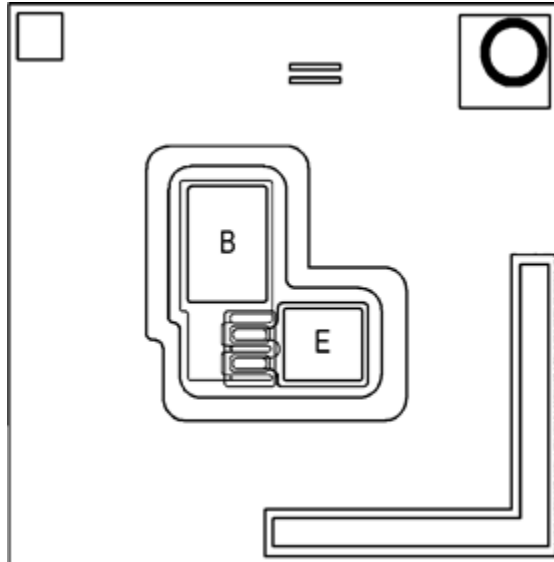

Die size:	.020 x .020 inch $\pm$ .002 inch.
Die thickness:	.010 $\pm$ .0015 inch nominal.
Top metal:	Aluminum 10,000Å minimum, 12,000Å nominal.
Back metal:	Gold 3,500Å minimum, 5,000Å nominal.
Backside:	Collector.
Bonding pad:	B = .004 x .0045 inch, E = .0045 x .005 inch.

FIGURE 6. JANHC and JANKC A-version die dimensions - 2N2369A.

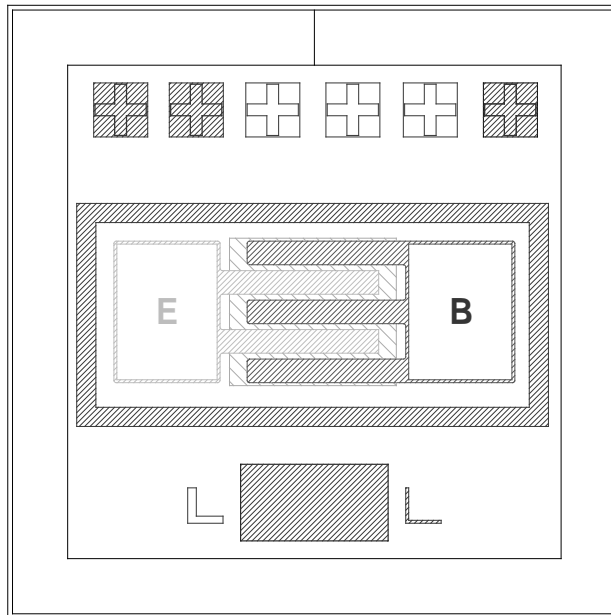

Die size:	.016 inch x .016 inch.
Die thickness:	.008 inch $\pm$ .0016 inch.
Base pad:	.0036 inch x .0028 inch.
Emitter pad:	.0036 inch x .0028 inch.
Back metal:	Gold, 6,500 $\pm$ 1,950 Å.
Top metal:	Aluminum, 17,500 $\pm$ 2,500 Å.
Back side:	Collector.
Glassivation:	SiO <sub>2</sub> , 7,500 $\pm$ 1,500 Å.

FIGURE 7. JANHC and JANKC B-version die dimensions - 2N2369A, 2N3227.

## 2. APPLICABLE DOCUMENTS

2.1 General. The documents listed in this section are specified in sections 3, 4, or 5 of this specification. This section does not include documents cited in other sections of this specification or recommended for additional information or as examples. While every effort has been made to ensure the completeness of this list, document users are cautioned that they must meet all specified requirements of documents cited in sections 3, 4, or 5 of this specification, whether or not they are listed.

### 2.2 Government documents.

2.2.1 Specifications, standards, and handbooks. The following specifications, standards, and handbooks form a part of this document to the extent specified herein. Unless otherwise specified, the issues of these documents are those cited in the solicitation or contract.

#### DEPARTMENT OF DEFENSE SPECIFICATIONS

MIL-PRF-19500 - Semiconductor Devices, General Specification for.

#### DEPARTMENT OF DEFENSE STANDARDS

MIL-STD-750 - Test Methods for Semiconductor Devices.

\* (Copies of these documents are available online at <https://assist.dla.mil/quicksearch/> or <https://assist.dla.mil/> or from the Standardization Document Order Desk, 700 Robbins Avenue, Building 4D, Philadelphia, PA 19111-5094.)

2.3 Order of precedence. Unless otherwise noted herein or in the contract, in the event of a conflict between the text of this document and the references cited herein, the text of this document takes precedence. Nothing in this document, however, supersedes applicable laws and regulations unless a specific exemption has been obtained.

## 3. REQUIREMENTS

3.1 General. The individual item requirements shall be as specified in MIL-PRF-19500 and as modified herein.

3.2 Qualification. Devices furnished under this specification shall be products that are manufactured by a manufacturer authorized by the qualifying activity for listing on the applicable qualified manufacturer's list (QML) before contract award (see 4.2 and 6.3).

3.3 Abbreviations, symbols, and definitions. Abbreviations, symbols, and definitions used herein shall be as specified in MIL-PRF-19500.

3.4 Interface and physical dimensions. The interface and physical dimensions shall be as specified in MIL-PRF-19500, and herein.

3.4.1 Lead finish. Lead finish shall be solderable in accordance with MIL-PRF-19500, MIL-STD-750, and herein. Where a choice of lead finish is desired, it shall be specified in the acquisition document (see 6.2).

3.5 Radiation hardness assurance (RHA). Radiation hardness assurance requirements, PIN designators, and test levels shall be as defined in MIL-PRF-19500.

\* 3.6 Electrical performance characteristics. Unless otherwise specified herein, the electrical performance characteristics are as specified in 1.3, 1.4, and table I herein. When a particular device is specified, the limit applies to all package types (e.g., 2N2369A, 2N2369AU, 2N2369AUA, 2N2369AUB, 2N2369AUBC, and 2N2369AUBCN).

3.7 Electrical test requirements. The electrical test requirements shall be specified in [table I](#). When a particular device is specified, the limit applies to all package types (e.g., 2N2369A, 2N2369AU, 2N2369AUA, 2N2369AUB, and 2N2369AUBC).

\* 3.8 Marking. Marking shall be in accordance with MIL-PRF-19500, except for the UB, UBC, and UBCN suffix package. Marking on the UB package shall consist of an abbreviated part number, the date code, and the manufacturers symbol or logo. The prefixes JAN, JANTX, JANTXV, and JANS can be abbreviated as J, JX, JV, and JS respectively. The "2N" prefix and the "AUB" suffix may also be omitted. The radiation hardened designator M, D, P, L, R, F, G, or H shall immediately precede (or replace) the device "2N" identifier (depending upon degree of abbreviation required).

3.9 Workmanship. Semiconductor devices shall be processed in such a manner as to be uniform in quality and shall be free from other defects that will affect life, serviceability, or appearance.

#### 4. VERIFICATION

4.1 Classification of inspections. The inspection requirements specified herein are classified as follows:

- a. Qualification inspection (see [4.2](#)).
- b. Screening (see [4.3](#)).
- c. Conformance inspection (see [4.4](#) and tables I, II, III, and IV).

4.2 Qualification inspection. Qualification inspection shall be in accordance with MIL-PRF-19500 and as specified herein.

4.2.1 Group E qualification. Group E inspection shall be performed for qualification or re-qualification only. In case qualification was awarded to a prior revision of the specification sheet that did not request the performance of [table IV](#) tests, the tests specified in [table IV](#) herein that were not performed in the prior revision shall be performed on the first inspection lot of this revision to maintain qualification.

4.3 Screening (JANS, JANTX, and JANTXV levels only). Screening shall be in accordance with table E-VI of MIL-PRF-19500, and as specified herein. The following measurements shall be made in accordance with [table I](#) herein. Devices that exceed the limits of [table I](#) herein shall not be acceptable.

Screen (see table E-IV of MIL-PRF-19500)	Measurement	
	JANS level	JANTX and JANTXV levels
(1) 3c	Thermal impedance (see 4.3.3)	Thermal impedance (see 4.3.3)
9	$I_{CES}$ and $h_{FE3}$	Not applicable
11	$I_{CES}$ ; $h_{FE3}$ ; $\Delta I_{CES}$ = 100 percent of initial value or 25 nA dc, whichever is greater. $\Delta h_{FE3}$ = $\pm 15$ percent of initial value.	$I_{CES}$ , $h_{FE3}$
12	See 4.3.1	See 4.3.1
13	Subgroups 2 and 3 of <a href="#">table I</a> herein; $\Delta I_{CES}$ = 100 percent of initial value or 25 nA dc, whichever is greater; $\Delta h_{FE3}$ = $\pm 15$ percent of initial value.	Subgroup 2 of <a href="#">table I</a> herein; $\Delta I_{CES}$ = 100 percent of initial value or 25 nA dc, whichever is greater; $\Delta h_{FE3}$ = $\pm 15$ percent of initial value.

(1) Shall be performed anytime after temperature cycling, screen 3a; JANTX and JANTXV do not need to be repeated in screening requirements.

4.3.1 Power burn-in conditions. Power burn-in conditions are as follows:  $V_{CE} = 5 - 15$  V dc,  $P_D = 360$  mW (500 mW for U),  $T_A =$  room ambient as defined in 4.5 of MIL-STD-750. With approval of the qualifying activity and preparing activity, alternate burn-in criteria (hours, bias conditions,  $T_J$ , mounting conditions) may be used for JANTX and JANTXV quality levels. A justification demonstrating equivalence is required. In addition, the manufacturing site's burn-in data and performance history will be essential criteria for burn-in modification approval.

4.3.2 Screening (JANHC and JANKC). Screening of JANHC and JANKC die shall be in accordance with appendix G of MIL-PRF-19500. Burn-in duration for the JANKC level follows JANS requirements; the JANHC follows JANTX requirements.

4.3.3 Thermal impedance ( $\Delta V_{BE}$  measurements). The  $\Delta V_{BE}$  measurements shall be performed in accordance with method 3131 of MIL-STD-750 using the guidelines in that method for determining  $V_H$ ,  $V_{CE}$ ,  $I_M$ ,  $I_H$ ,  $t_H$ ,  $t_{SW}$ , and  $t_{MD}$ . The  $\Delta V_{BE}$  limit used in screen 3c of 4.3 herein and table I, subgroup 2 shall be set statistically by the supplier over several die lots and submitted to the qualifying activity for approval. See table IV, group E, subgroup 4 and figures 9, 10, 11, 12, and 13 herein.

4.4 Conformance inspection. Conformance inspection shall be in accordance with MIL-PRF-19500, and as specified herein. If alternate screening is being performed in accordance with MIL-PRF-19500, a sample of screened devices shall be submitted to and pass the requirements of group A1 and A2 inspection only (table E-VIb, group B, subgroup 1 is not required to be performed again if group B has already been satisfied in accordance with 4.4.2).

4.4.1 Group A inspection. Group A inspection shall be conducted in accordance with MIL-PRF-19500, and table I herein.

4.4.2 Group B inspection. Group B inspection shall be conducted in accordance with the tests and conditions specified for subgroup testing in table E-VIa (JANS) of MIL-PRF-19500 and 4.4.2.1. Electrical measurements (end-points) shall be in accordance with table I, subgroup 2. Delta requirements shall be in accordance with table II herein. See 4.4.2.2 for JAN, JANTX, and JANTXV group B testing. Electrical measurements (end-points) for JAN, JANTX, and JANTXV shall be after each step in 4.4.2.2 and shall be in accordance with table I, subgroup 2 herein. Delta measurements shall be in accordance with table III herein.

4.4.2.1 Group B inspection, table E-VIa (JANS) of MIL-PRF-19500.

Subgroup Method Condition

B4	1037	$V_{CB} = 12$ V dc, $t_{ON} = t_{OFF} = 3$ minutes, $P_{D(ON)} = P_D$ max rated, see 1.3; $P_{D(OFF)} = 0$ .
B5	1027	$V_{CB} = 12$ V dc. $P_D \geq 100$ percent of maximum rated $P_T$ (see 1.3). Option 1: 96 hrs min, Sample size in accordance with table E-VIa of MIL-PRF-19500, adjust $T_A$ to achieve $T_J = +275^\circ\text{C}$ minimum. Option 2: 216 hrs min., sample size = 45, $c = 0$ ; adjust $T_A$ to achieve $T_J = +225^\circ\text{C}$ minimum. (NOTE: If a failure occurs, resubmission shall be at the test conditions of the original sample.)

MIL-PRF-19500/317P

\* 4.4.2.2 Group B inspection, (JAN, JANTX, and JANTXV) Separate samples may be used for each step. In the event of a group B failure, the manufacturer may pull a new sample at double the sample size from either the failed assembly lot or from another assembly lot from the same wafer lot. If the new assembly lot option is exercised, the failed assembly lot shall be scrapped.

<u>Step</u>	<u>Method</u>	<u>Condition</u>
* 1	1026	Steady-state life: 1,000 hours at $V_{CB} = 10$ V dc; Maximum rated power (see 1.3) shall be applied to the device and ambient temperature shall be adjusted to achieve $T_J \geq +150^\circ\text{C}$ . $n = 45$ , $c = 0$ . The sample size may be increased and the test time decreased as long as the devices are stressed for a total of 45,000 device hours minimum and the actual time of test is at least 340 hours.
2	1048	Blocking life: $T_A = +150^\circ$ , $V_{CB} = 80$ percent of rated voltage, 48 hours minimum. $n = 45$ devices, $c = 0$ .
3	1032	High-temperature life (non-operating), $t = 340$ hours, $T_A = +200^\circ\text{C}$ . $n = 22$ , $c = 0$ .

4.4.2.3 Group B sample selection. Samples selected from group B inspection shall meet all of the following requirements:

- a. For JAN, JANTX, and JANTXV samples shall be selected randomly from a minimum of three wafers (or from each wafer in the lot) from each wafer lot. For JANS, samples shall be selected from each inspection lot. See MIL-PRF-19500.
- b. Shall be chosen from an inspection lot that has been submitted to and passed group A, subgroup 2, conformance inspection. When the final lead finish is solder or any plating prone to oxidation at high temperature, the samples for life test (subgroups B4 and B5 for JANS, and group B for JAN, JANTX, and JANTXV) may be pulled prior to the application of final lead finish.

4.4.3 Group C inspection. Group C inspection shall be conducted in accordance with the tests and conditions specified for subgroup testing in table E-VII of MIL-PRF-19500, and in 4.4.3.1 (JANS) and 4.4.3.2 (JAN, JANTX, and JANTXV) herein for group C testing. Electrical measurements (end-points) shall be in accordance with table I, subgroup 2. Delta requirements shall be in accordance with table III herein.

4.4.3.1 Group C inspection, table E-VII (JANS) of MIL-PRF-19500.

<u>Subgroup</u>	<u>Method</u>	<u>Condition</u>
C2	2036	Test condition E; not applicable for U, UA, and UB devices.
C6	1026	1,000 hours at $V_{CB} = 5 - 15$ V dc. Maximum rated power (see 1.3) shall be applied to the device and ambient temperature shall be adjusted to achieve $T_J \geq +150^\circ\text{C}$ . The sample size may be increased and the test time decreased as long as the devices are stressed for a total of 45,000 device hours minimum, and the actual time of test is at least 340 hours. $n = 45$ , $c = 0$ .

4.4.3.2 Group C inspection, table E-VII (JAN, JANTX, and JANTXV) of MIL-PRF-19500.

<u>Subgroup</u>	<u>Method</u>	<u>Condition</u>
C2	2036	Test condition E; not applicable for U, UA, and UB devices.
C6		Not applicable.

4.4.3.3 Group C sample selection. Samples for subgroups in group C shall be chosen at random from any inspection lot containing the intended package type and lead finish procured to the same specification which is submitted to and passes group A tests for conformance inspection. When the final lead finish is solder or any plating prone to oxidation at high temperature, the samples for C6 life test may be pulled prior to the application of final lead finish. Testing of a subgroup using a single device type enclosed in the intended package type shall be considered as complying with the requirements for that subgroup.

\* 4.4.4 Group D inspection. Conformance inspection for hardness assured JANS, JANJ, and JANTXV types shall include the group D tests specified in [table II](#) herein. These tests shall be performed as required in accordance with MIL-PRF-19500 and method 1019 of MIL-STD-750, for total ionizing dose or method 1017 of MIL-STD-750 for neutron fluence as applicable (see [6.2](#) herein), except group D, subgroup 2 may be performed separate from other subgroups. Alternate package options may also be substituted for the testing provided there is no adverse effect to the fluence profile.

4.4.5 Group E inspection. Group E inspection shall be conducted in accordance with the conditions specified for subgroup testing in appendix E, table E-IX of MIL-PRF-19500 and as specified in [table IV](#) herein. Electrical measurements (end-points) shall be in accordance with [table I](#), subgroup 2. Delta requirements shall be in accordance with [table III](#) herein.

4.5 Methods of inspection. Methods of inspection shall be as specified in the appropriate tables and as follows.

4.5.1 Pulse measurements. Conditions for pulse measurement shall be as specified in section 4 of MIL-STD-750.

4.5.2 Input capacitance. This test shall be conducted in accordance with method 3240 of MIL-STD-750, except the output capacitor shall be omitted.

MIL-PRF-19500/317P

TABLE I. Group A inspection.

Inspection <u>1/ 2/</u>	MIL-STD-750		Symbol	Limit		Unit
	Method	Conditions		Min	Max	
<u>Subgroup 1 3/</u>						
Visual and mechanical <u>4/</u> examination	2071					
Solderability <u>4/ 5/</u>	2026	n = 15 leads, c = 0				
Resistance to solvents <u>4/ 5/ 6/</u>	1022	n = 15 devices, c = 0				
Temp cycling <u>4/ 5/</u>	1051	Test condition C, 25 cycles. n = 22 devices, c = 0				
Hermetic seal <u>5/</u> Fine leak Gross leak	1071	n = 22 devices, c = 0 Test conditions G or H Test conditions C or D				
Electrical measurements <u>5/</u>		<a href="#">Table I</a> , subgroup 2				
Bond strength <u>4/ 5/</u>	2037	Precondition T <sub>A</sub> = +250°C at t = 24 hrs or T <sub>A</sub> = 300°C at t = 2 hrs; n = 11 wires, c = 0				
Decap internal visual <u>5/</u>	2075	n = 4 devices, c = 0				
<u>Subgroup 2</u>						
Thermal impedance <u>7/</u>	3131	See <a href="#">4.3.3</a>	$\Delta V_{BE}$			mV
Collector to base cutoff current	3036	V <sub>CB</sub> = 40 V dc	I <sub>CB01</sub>		10	μA dc
Emitter to base cutoff current 2N2369A, 2N4449 2N3227	3061	V <sub>EB</sub> = 4.5 V dc V <sub>EB</sub> = 6.0 V dc	I <sub>EBO1</sub>		10	μA dc
Breakdown voltage, collector to emitter 2N2369A, 2N4449 2N3227	3011	Bias condition D; I <sub>C</sub> = 10 mA dc; pulsed (see <a href="#">4.5.1</a> )	V <sub>(BR)CEO</sub>	15 20		V dc V dc
Collector to emitter cutoff current	3041	Bias condition C; V <sub>CE</sub> = 20 V dc	I <sub>CE5</sub>		0.4	μA dc
Collector to base cutoff current	3036	Bias condition D; V <sub>CB</sub> = 32 V dc	I <sub>CB02</sub>		0.2	μA dc
Emitter to base cutoff current	3061	Bias condition D; V <sub>EB</sub> = 4 V dc	I <sub>EBO2</sub>		0.25	μA dc
Forward-current transfer ratio 2N2369A, 2N4449, 2N3227	3076	V <sub>CE</sub> = 0.35 V dc; I <sub>C</sub> = 10 mA dc pulsed (see <a href="#">4.5.1</a> ).	h <sub>FE1</sub>	40 70	120 250	
Forward-current transfer ratio 2N2369A, 2N4449 2N3227	3076	V <sub>CE</sub> = 0.4 V dc; I <sub>C</sub> = 30 mA dc pulsed (see <a href="#">4.5.1</a> ).	h <sub>FE2</sub>	30 40	120 250	

See footnotes at end of table.



TABLE I. Group A inspection - Continued.

Inspection <u>1/ 2/</u>	MIL-STD-750		Symbol	Limit		Unit
	Method	Conditions		Min	Max	
<u>Subgroup 2</u> - Continued						
Forward-current transfer ratio 2N2369A, 2N4449 2N3227	3076	$V_{CE} = 1.0 \text{ V dc}; I_C = 10 \text{ mA dc}$ pulsed (see 4.5.1).	$h_{FE3}$	40 75	120 300	
Forward-current transfer ratio 2N2369A, 2N4449 2N3227	3076	$V_{CE} = 1.0 \text{ V dc}; I_C = 100 \text{ mA dc};$ pulsed (see 4.5.1).	$h_{FE4}$	20 30	120 150	
Collector-emitter saturation voltage	3071	$I_C = 10 \text{ mA dc}; I_B = 1.0 \text{ mA dc}$ pulsed (see 4.5.1).	$V_{CE(sat)1}$		0.20	V dc
Collector-emitter saturation voltage	3071	$I_C = 30 \text{ mA dc}; I_B = 3.0 \text{ mA dc};$ pulsed (see 4.5.1).	$V_{CE(sat)2}$		0.25	V dc
Collector-emitter saturation voltage	3071	$I_C = 100 \text{ mA dc}; I_B = 10 \text{ mA dc};$ pulsed (see 4.5.1).	$V_{CE(sat)3}$		0.45	V dc
Base-emitter saturation voltage	3066	Test condition A; $I_C = 10 \text{ mA dc};$ $I_B = 1.0 \text{ mA dc};$ pulsed (see 4.5.1).	$V_{BE(sat)1}$	0.70	0.85	V dc
Base-emitter saturation voltage	3066	Test condition A; $I_C = 30 \text{ mA dc};$ $I_B = 3.0 \text{ mA dc};$ pulsed (see 4.5.1).	$V_{BE(sat)2}$		0.90	
Base-emitter saturation voltage	3066	Test condition A; $I_C = 100 \text{ mA dc};$ $I_B = 10 \text{ mA dc};$ pulsed (see 4.5.1).	$V_{BE(sat)3}$	0.80	1.20	V dc
<u>Subgroup 3</u>						
High temperature operation		$T_A = +150^\circ\text{C}$				
Collector to base cutoff current	3036	Bias condition D; $V_{CB} = 20 \text{ V dc}$	$I_{CBO2}$		30	$\mu\text{A dc}$
High temperature operation		$T_A = +125^\circ\text{C}$				
Collector to base cutoff current	3041	Bias condition A; $V_{CE} = 10 \text{ V dc};$ $V_{BE} = 0.25 \text{ V dc}$	$I_{CEX2}$		30	$\mu\text{A dc}$
Collector - emitter voltage saturated	3071	$I_C = 10 \text{ mA dc}$ $I_B = 1.0 \text{ mA dc}$	$V_{CE(sat)4}$		0.3	V dc
Base - emitter saturated voltage 2N2369A, 2N4449 2N3227	3066	Test condition A; $I_C = 10 \text{ mA dc};$ $I_B = 1.0 \text{ mA dc}$	$V_{BE(sat)4}$	0.59 0.50		V dc V dc
Low temperature operation		$T_A = -55^\circ\text{C}$				
Forward-current transfer ratio 2N2369A, 2N4449 2N3227	3076	$V_{CE} = 1.0 \text{ V dc}; I_C = 10 \text{ mA dc}$ pulsed (see 4.5.1)	$h_{FE5}$	20 40		
Base - emitter saturated voltage	3066	Test condition A; $I_C = 10 \text{ mA dc};$ $I_B = 1.0 \text{ mA dc}$	$V_{BE(sat)5}$		1.02	V dc

See footnotes at end of table.

TABLE I. Group A inspection - Continued.

Inspection <u>1/</u> <u>2/</u>	MIL-STD-750		Symbol	Limit		Unit
	Method	Conditions		Min	Max	
<u>Subgroup 4</u>						
Magnitude of small-signal short-circuit forward current transfer ratio	3306	$V_{CE} = 10 \text{ V dc}; I_C = 10 \text{ mA dc}; f = 100 \text{ MHz}$	$ h_{fe} $	5.0	10	
Open circuit output capacitance	3236	$V_{CB} = 5 \text{ V dc}; I_E = 0; 100 \text{ kHz} \leq f \leq 1 \text{ MHz}$	$C_{obo}$		4.0	pF
Input capacitance (output open-circuited) 2N2369A, 2N4449 2N3227	3240	$V_{EB} = 0.5 \text{ V dc}; I_C = 0; 100 \text{ kHz} \leq f \leq 1 \text{ MHz}$	$C_{ibo}$		5.0	pF
					4.0	pF
Charge storage time 2N2369A, 2N4449 2N3227		$I_C = 10 \text{ mA dc}; I_{B1} = 10 \text{ mA dc}; I_{B2} = 10 \text{ mA dc};$ (see <a href="#">figure 14</a> )	$t_s$			
					13 18	ns ns
Turn-on time		$I_C = 10 \text{ mA dc}; I_{B1} = 3.0 \text{ mA dc}; I_{B2} = -1.5 \text{ mA dc};$ (see <a href="#">figure 15</a> )	$t_{on}$		12	ns
Turn-off time 2N2369A, 2N4449 2N3227		$I_C = 10 \text{ mA dc}; I_{B1} = 3.0 \text{ mA dc}; I_{B2} = -1.5 \text{ mA dc};$ (see <a href="#">figure 15</a> )	$t_{off}$			
					18 25	ns ns

- 1/ For sampling (unless otherwise specified) plan see MIL-PRF-19500.
- \* 2/ Electrical characteristics for the A, AU, AUBC, U, UA, UB,UBC, and UBCN suffix devices are identical to the corresponding non-suffix device.
- 3/ For resubmission of failed subgroup 1, double the sample size of the failed test or sequence of tests. A failure in [table I](#), subgroup 1 shall not require retest of the entire subgroup. Only the failed test shall be rerun upon submission.
- 4/ Separate samples may be used.
- 5/ Not required for JANS devices.
- 6/ Not required for laser marked devices.
- 7/ This test required for the following end-point measurements only:  
Group B, subgroups 3, 4, and 5 (JANS).  
Group B, steps 2 and 3 (JAN, JANTX, and JANTXV).  
Group C, subgroup 2 and 6.  
Group E, subgroup 1.

MIL-PRF-19500/317P

TABLE II. Group D inspection.

Inspection <u>1/ 2/ 3/</u>	MIL-STD-750		Symbol	Limit		Unit
	Method	Conditions		Min	Max	
<u>Subgroup 1 4/</u>						
Neutron irradiation	1017	Neutron exposure $V_{CES} = 0V$				
Collector to base cutoff current	3036	$V_{CB} = 40 V$ dc	$I_{CBO1}$		20	$\mu A$ dc
Emitter to base cutoff current 2N2369A, 2N4449 2N3227	3061	$V_{EB} = 4.5 V$ dc $V_{EB} = 6.0 V$ dc	$I_{EBO1}$		20	$\mu A$ dc
Breakdown voltage, collector to emitter 2N2369A, 2N4449 2N3227	3011	Bias condition D; $I_C = 10 mA$ dc; pulsed (see 4.5.1)	$V_{(BR)CEO}$	15 20		V dc V dc
Collector to emitter cutoff current	3041	Bias condition C; $V_{CE} = 20 V$ dc	$I_{CES}$		0.8	$\mu A$ dc
Collector to base cutoff current	3036	Bias condition D; $V_{CB} = 32 V$ dc	$I_{CBO2}$		0.4	$\mu A$ dc
Emitter to base cutoff current	3061	Bias condition D; $V_{EB} = 4 V$ dc	$I_{EBO2}$		0.50	$\mu A$ dc
Forward-current transfer ratio M through H2N2369A, 2N4449 M through H2N3277	3076	$V_{CE} = 0.35 V$ dc; $I_C = 10 mA$ dc pulsed (see 4.5.1).	$[h_{FE1}]$ <u>5/</u>	[20] [35]	120 250	
Forward-current transfer ratio M through H2N2369A, 2N4449 M through H2N3277	3076	$V_{CE} = 0.4 V$ dc; $I_C = 30 mA$ dc, pulsed (see 4.5.1).	$[h_{FE2}]$ <u>5/</u>	[15] [20]	120 250	
Forward-current transfer ratio M through H2N2369A, 2N4449 M through H2N3277	3076	$V_{CE} = 1.0 V$ dc; $I_C = 10 mA$ dc, pulsed (see 4.5.1).	$[h_{FE3}]$ <u>5/</u>	[20] [37.5]	120 300	
Forward-current transfer ratio M through H2N2369A, 2N4449 M through H2N3277	3076	$V_{CE} = 1.0 V$ dc; $I_C = 100 mA$ dc pulsed (see 4.5.1).	$[h_{FE4}]$ <u>5/</u>	[10] [15]	120 150	
Collector-emitter saturation voltage	3071	$I_C = 10 mA$ dc; $I_B = 1 mA$ dc pulsed (see 4.5.1).	$V_{CE(sat)1}$		0.23	V dc
Collector-emitter saturation voltage	3071	$I_C = 30 mA$ dc; $I_B = 3.0 mA$ dc pulsed (see 4.5.1).	$V_{CE(sat)2}$		0.29	V dc
Collector-emitter saturation voltage	3071	$I_C = 100 mA$ dc; $I_B = 10 mA$ dc pulsed (see 4.5.1).	$V_{CE(sat)3}$		0.52	V dc

See footnotes at end of table.

MIL-PRF-19500/317P

TABLE II. Group D inspection - Continued.

Inspection <u>1/ 2/ 3/</u>	MIL-STD-750		Symbol	Limit		Unit
	Method	Conditions		Min	Max	
<u>Subgroup 1 4/</u> - Continued.						
Base-emitter saturation voltage	3066	Test condition A; $I_C = 10$ mA dc; $I_B = 1.0$ mA dc; pulsed (see 4.5.1).	$V_{BE(sat)1}$	0.70	0.98	V dc
Base-emitter saturation voltage	3066	Test condition A; $I_C = 30$ mA dc; $I_B = 3.0$ mA dc; pulsed (see 4.5.1).	$V_{BE(sat)2}$		1.04	
Base-emitter saturation voltage	3066	Test condition A; $I_C = 100$ mA dc; $I_B = 10$ mA dc; pulsed (see 4.5.1).	$V_{BE(sat)3}$	0.80	1.38	V dc
<u>Subgroup 2</u>						
Total dose irradiation	1019	Gamma exposure Condition A. $V_{CES} = 12$ V $V_{CES} = 16$ V				
M through H2N2369A, 2N4449 M through H2N3277						
Collector to base cutoff current	3036	$V_{CB} = 40$ V dc	$I_{CBO1}$		20	$\mu$ A dc
Emitter to base cutoff current 2N2369A, 2N4449 2N3227	3061	$V_{EB} = 4.5$ V dc $V_{EB} = 6.0$ V dc	$I_{EBO1}$		20	$\mu$ A dc
Breakdown voltage, collector to emitter 2N2369A, 2N4449 2N3227	3011	Bias condition D; $I_C = 10$ mA dc; pulsed (see 4.5.1)	$V_{(BR)CEO}$	15 20		V dc V dc
Collector to emitter cutoff current	3041	Bias condition C; $V_{CE} = 20$ V dc	$I_{CES}$		0.8	$\mu$ A dc
Collector to base cutoff current	3036	Bias condition D; $V_{CB} = 32$ V dc	$I_{CBO2}$		0.4	$\mu$ A dc
Emitter to base cutoff current	3061	Bias condition D; $V_{EB} = 4$ V dc	$I_{EBO2}$		0.50	$\mu$ A dc
Forward-current transfer ratio M through H2N2369A, 2N4449 M through H2N3277	3076	$V_{CE} = 0.35$ V dc; $I_C = 10$ mA dc. pulsed(see 4.5.1).	$[h_{FE1}] \underline{5/}$	[20] [35]	120 250	
Forward-current transfer ratio M through H2N2369A, 2N4449 M through H2N3277	3076	$V_{CE} = 0.4$ V dc; $I_C = 30$ mA dc. pulsed(see 4.5.1).	$[h_{FE2}] \underline{5/}$	[15] [20]	120 250	
Forward-current transfer ratio M through H2N2369A, 2N4449 M through H2N3277	3076	$V_{CE} = 1.0$ V dc; $I_C = 10$ mA dc. pulsed(see 4.5.1).	$[h_{FE3}] \underline{5/}$	[20] [37.5]	120 300	

See footnotes at end of table.

TABLE II. Group D inspection - Continued.

Inspection <u>1/</u> <u>2/</u> <u>3/</u>	MIL-STD-750		Symbol	Limit		Unit
	Method	Conditions		Min	Max	
<u>Subgroup 2</u> - Continued.						
Forward-current transfer ratio M through H2N2369A, 2N4449 M through H2N3277	3076	$V_{CE} = 1.0$ V dc; $I_C = 100$ mA dc. pulsed(see 4.5.1).	$[h_{FE4}]$ <u>5/</u>	[10] [15]	120 150	
Collector-emitter saturation voltage	3071	$I_C = 10$ mA dc; $I_B = 1.0$ mA dc. pulsed (see 4.5.1).	$V_{CE(sat)1}$		0.23	V dc
Collector-emitter saturation voltage	3071	$I_C = 30$ mA dc; $I_B = 3.0$ mA dc. pulsed (see 4.5.1).	$V_{CE(sat)2}$		0.29	V dc
Collector-emitter saturation voltage	3071	$I_C = 100$ mA dc; $I_B = 10$ mA dc. pulsed (see 4.5.1).	$V_{CE(sat)3}$		0.52	V dc
Base-emitter saturation voltage	3066	Test condition A; $I_C = 10$ mA dc; $I_B = 1.0$ mA dc; pulsed (see 4.5.1).	$V_{BE(sat)1}$	0.70	0.98	V dc
Base-emitter saturation voltage	3066	Test condition A; $I_C = 30$ mA dc; $I_B = 3.0$ mA dc; pulsed (see 4.5.1).	$V_{BE(sat)2}$		1.04	V dc
Base-emitter saturation voltage	3066	Test condition A; $I_C = 100$ mA dc; $I_B = 10$ mA dc; pulsed (see 4.5.1).	$V_{BE(sat)3}$	0.80	1.38	V dc

1/ Tests to be performed on all devices receiving radiation exposure.

2/ For sampling plan, see MIL-PRF-19500.

\* 3/ Electrical characteristics apply to the corresponding A, AU, AUBC, U, UA, UB, UBC, and UBCN suffix versions unless otherwise noted.

4/ See 6.2.e herein.

5/ See method 1019 of MIL-STD-750 for how to determine  $[h_{FE}]$  by first calculating the delta ( $1/h_{FE}$ ) from the pre- and post-radiation  $h_{FE}$ . Notice the  $[h_{FE}]$  is not the same as  $h_{FE}$  and cannot be measured directly. The  $[h_{FE}]$  value can never exceed the pre-radiation minimum  $h_{FE}$  that it is based upon.

TABLE III. Groups B, C, and E delta measurements.

Step	Inspection <u>1/</u> <u>2/</u> <u>3/</u> <u>4/</u>	MIL-STD-750		Symbol	Limit
		Method	Conditions		
1.	Forward-current transfer ratio	3076	$V_{CE} = 1.0 \text{ V dc}; I_C = 10 \text{ mA dc};$ pulsed (see 4.5.1)	$\Delta h_{FE3}$	$\pm 25$ percent change from initial value.
2.	Collector - emitter and resistance	3071	$I_C = 10 \text{ mA dc}$ $I_B = 1.0 \text{ mA dc}$	$\Delta V_{CE(sat)1}$	$\pm 50$ mV change from previous measured value.
3.	Collector - emitter cutoff current	3041	Bias condition C; $V_{CE} = 20 \text{ V dc}$	$\Delta I_{CES}$	100 percent of initial value or 25 nA dc, whichever is greater.

1/ The delta measurements for table E-VIa (JANS) of MIL-PRF-19500 are as follows: Subgroups B4 and B5, see [table III](#) herein, steps 1, 2, and 3.

2/ The delta measurements (JAN, JANTX, and JANTXV) of [4.4.2.2](#) herein are as follows: Steps 1, 2, and 3, see [table III](#) herein, steps 1 and 3.

3/ The delta measurements for table E-VII of MIL-PRF-19500 and [4.4.3.1](#) are as follows: Subgroup 6, see [table III](#) herein, steps 2 and 3 (for JANS).

4/ The delta measurements for table E-IX of MIL-PRF-19500 and [table III](#) herein are as follows: Subgroups 1 and 2, see [table III](#) herein, all steps.

MIL-PRF-19500/317P

TABLE IV. Group E inspection (all quality levels) – for qualification or re-qualification only.

Inspection	MIL-STD-750		Qualification
	Method	Conditions	
<u>Subgroup 1</u>			45 devices c = 0
Temperature cycling (air to air)	1051	Test condition C, 500 cycles.	
Hermetic seal Fine leak Gross leak	1071	Test conditions G or H.	
Electrical measurements		See <a href="#">table I</a> , subgroup 2 and <a href="#">table III</a> herein.	
<u>Subgroup 2</u>			45 devices c = 0
Intermittent life	1037	Intermittent operation life: $V_{CB} = 10$ V dc; 6,000 cycles, $t_{ON} = t_{OFF} = 3$ minutes, $P_{DON} = P_D$ max rated in accordance with 1.3; $P_{DOFF} = 0$ .	
Electrical measurements		See <a href="#">table I</a> , subgroup 2 and <a href="#">table III</a> herein.	
<u>Subgroup 4</u>			Sample size N/A
Thermal impedance curves		See table E-IX, subgroup 4 of MIL PRF-19500.	
<u>Subgroup 5</u>			
Not applicable			
<u>Subgroup 6</u>			11 devices
ESD	1020		
<u>Subgroup 8</u>			45 devices c = 0
Reverse stability	1033	Condition B.	

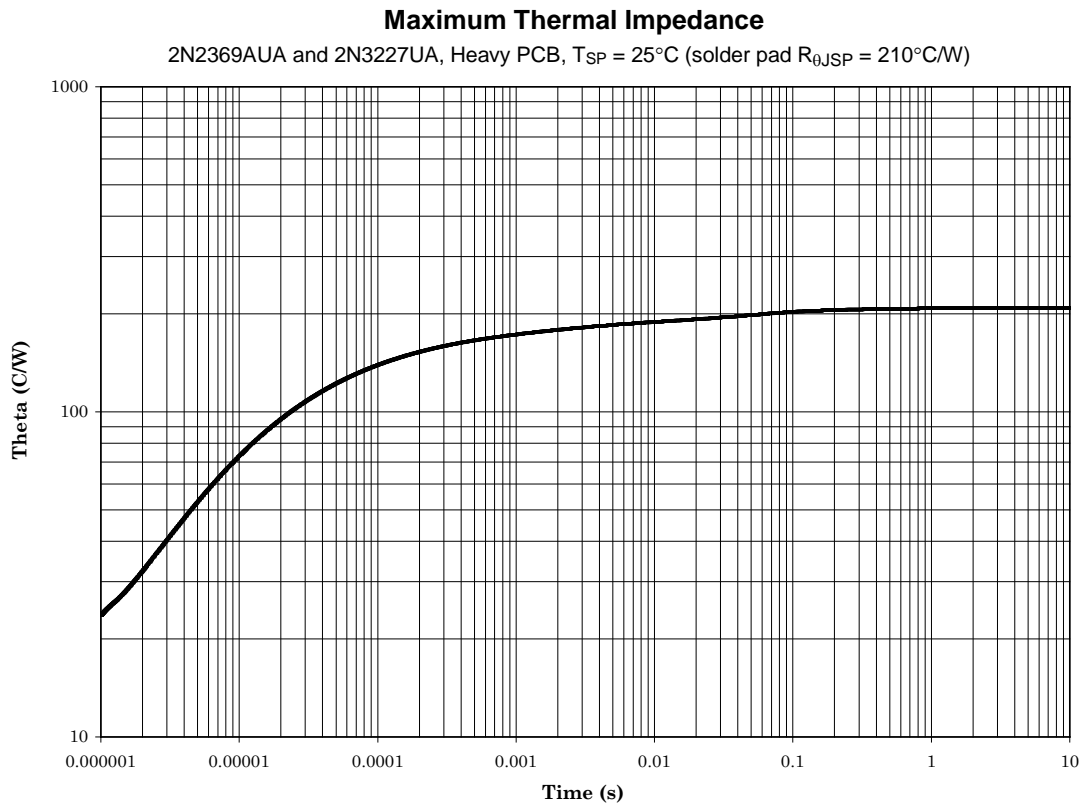

FIGURE 8. Thermal impedance graph ( $R_{\theta JSP}$ ) for 2N2369AUA and 2N3227UA.



**Maximum Thermal Impedance**  
2N2369AUB, 2N2369AUBC, 2N3227UB, and 2N3227UBC  
Heavy PCB,  $T_{SP} = 25^{\circ}\text{C}$  (solder pad  $R_{\theta JSP} = 210^{\circ}\text{C/W}$ )

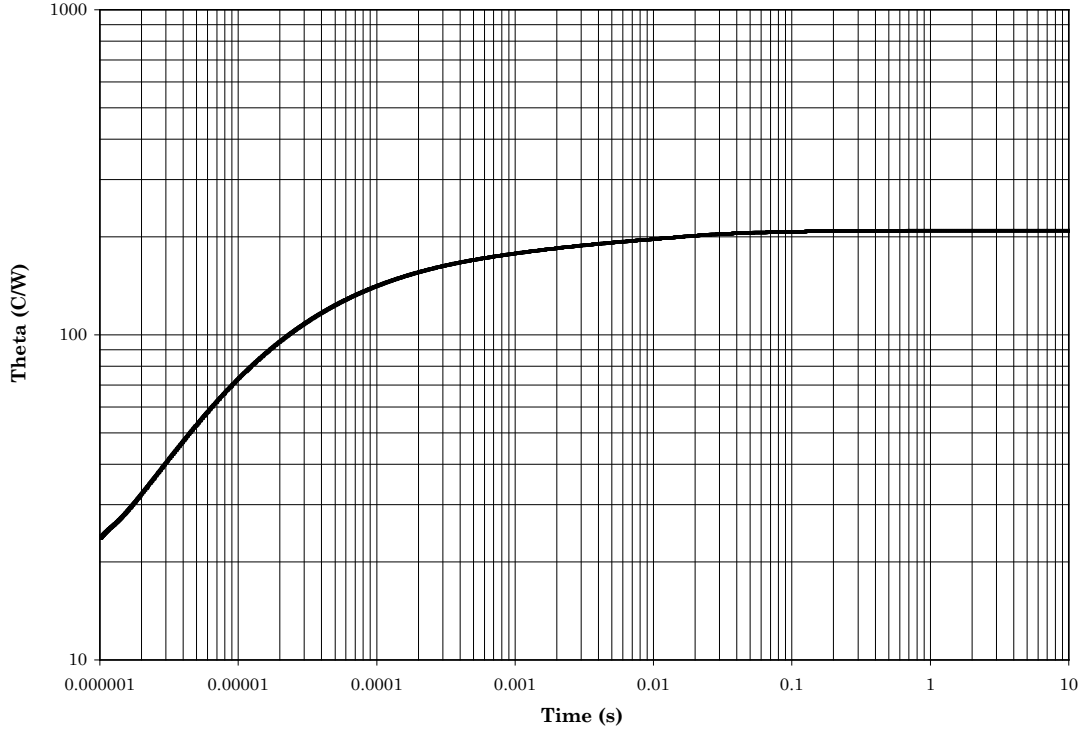

FIGURE 9. Thermal impedance graph ( $R_{\theta JSP}$ ) for 2N2369AUB, 2N2369AUBC, 2N3227UB, and 2N3227UBC.

### Maximum Thermal Impedance 2N4449 TO-46 Free Air

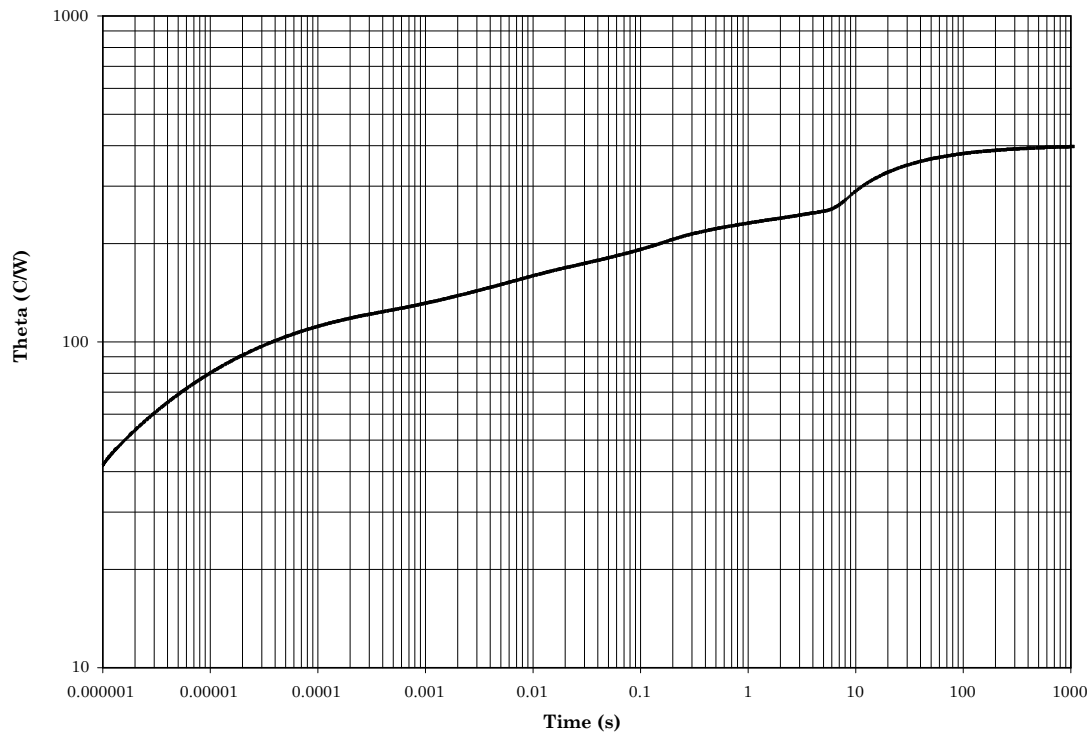

FIGURE 10. Thermal impedance graph TO-46 ( $R_{\theta JA}$ ) for 2N4449.

**Maximum Thermal Impedance**  
2N2369A 020C Chip TO-18 Free Air

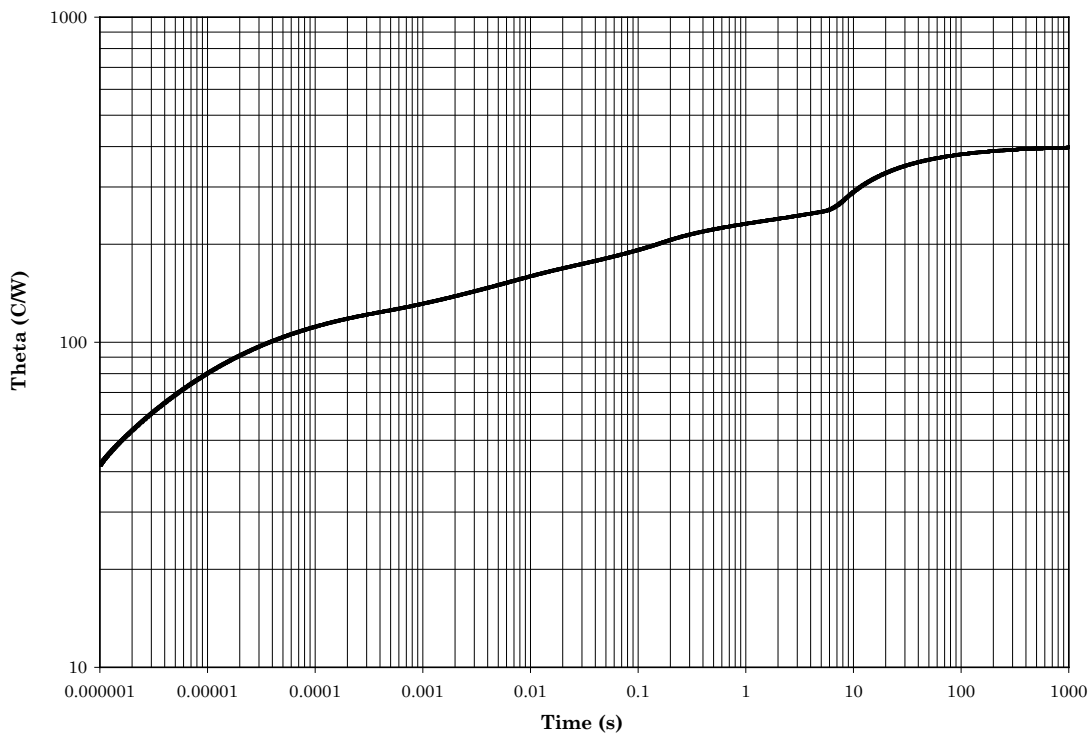

FIGURE 11. Thermal impedance graph (TO-18) ( $R_{\theta JA}$ ) for 2N2369A and 2N3227.

**Maximum Thermal Impedance**

**2N2369A 020C Chip TO-18 Case Mount (Bottom Plane)**

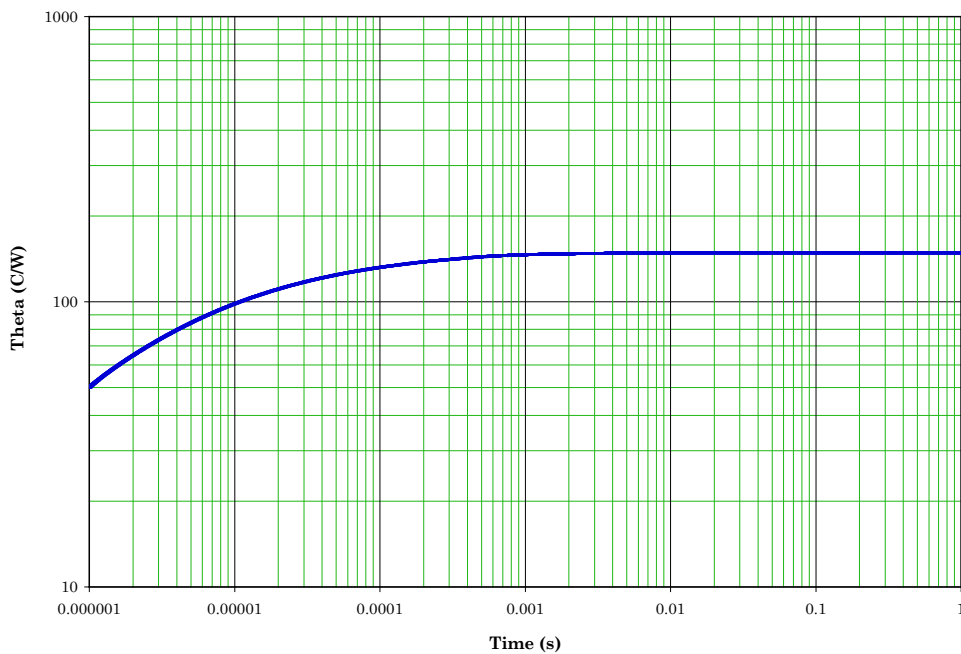

FIGURE 12. Thermal impedance graph (TO-18 TO-46) ( $R_{\theta JC}$ ) for 2N2369A.

### Maximum Thermal Impedance

20x20 Chip in U LCC6 Pkg, Heavy PCB, Tsp=25C,  $\theta_{j\text{sp}}=210\text{C/W}$ , Side 1 of 2

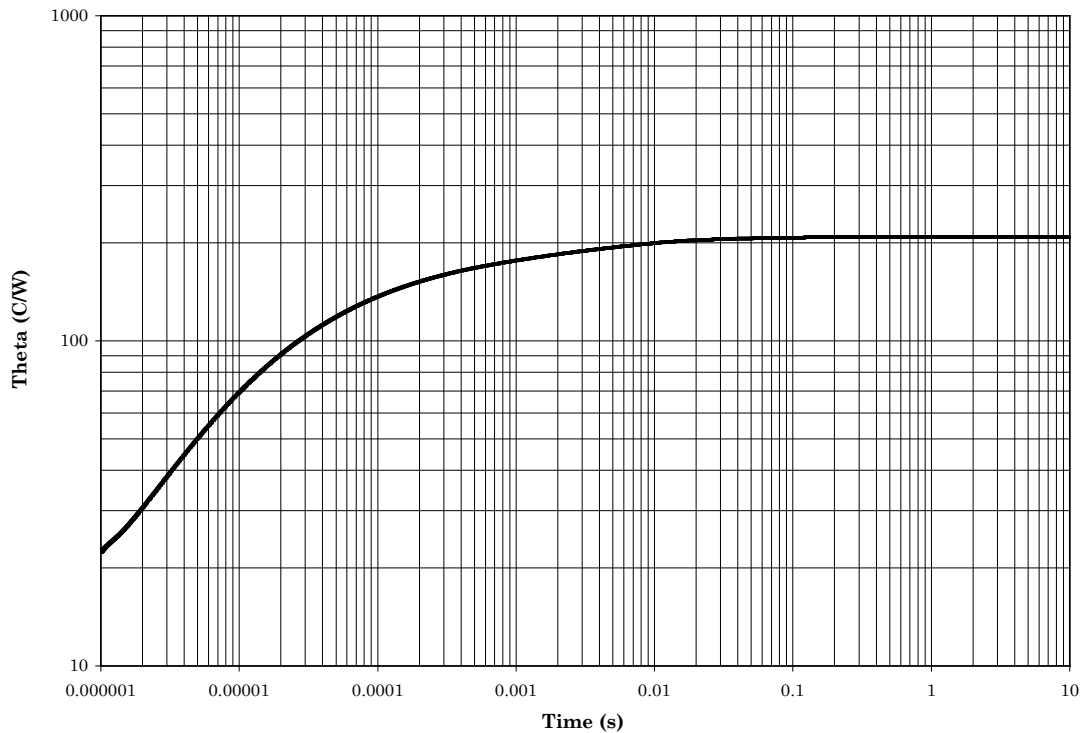
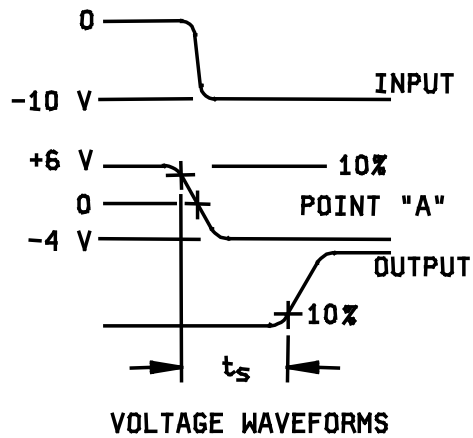
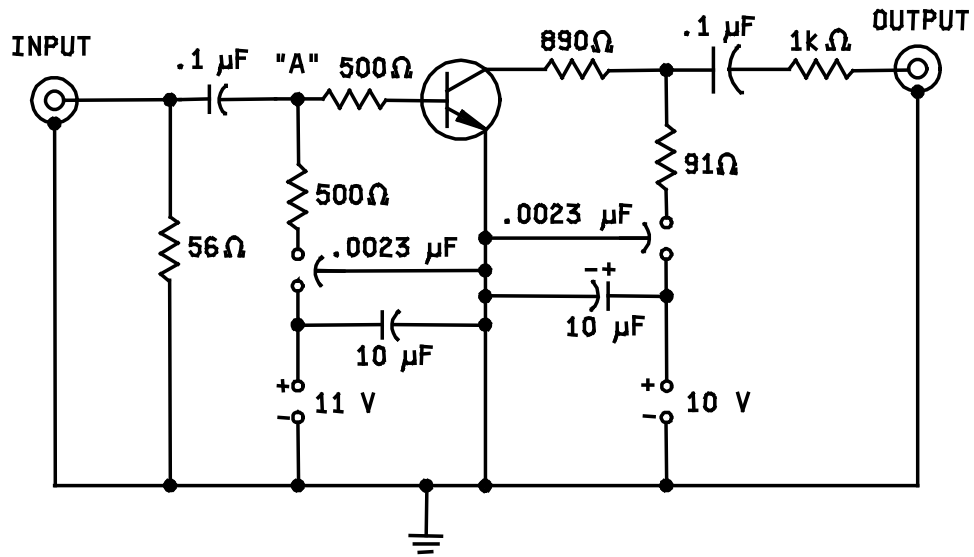

FIGURE 13. Thermal impedance graph ( $R_{\theta\text{JSP}}$ ) for 2N2369AU and 2N3227U.



**NOTES:**

1. All capacitance in  $\mu\text{F}$ .
2. The input waveforms for each circuit are supplied by a pulse generator with the following characteristics:  $Z_{\text{OUT}} = 50\Omega$ ,  $t_r \leq 1 \text{ ns}$ ,  $\text{PW} \geq 300 \text{ ns}$ , duty cycle  $\leq 2$  percent.
3. Output waveforms are monitored on an oscilloscope with the following characteristics:  $t_r \leq .1 \text{ ns}$ ,  $Z_{\text{IN}} = 50\Omega$ .

FIGURE 14. Charge storage time test circuit.

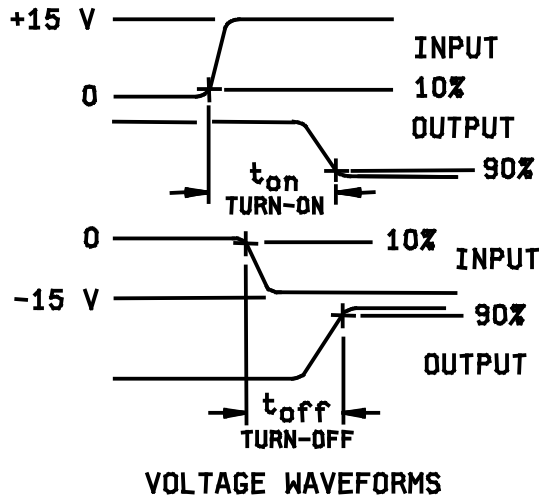
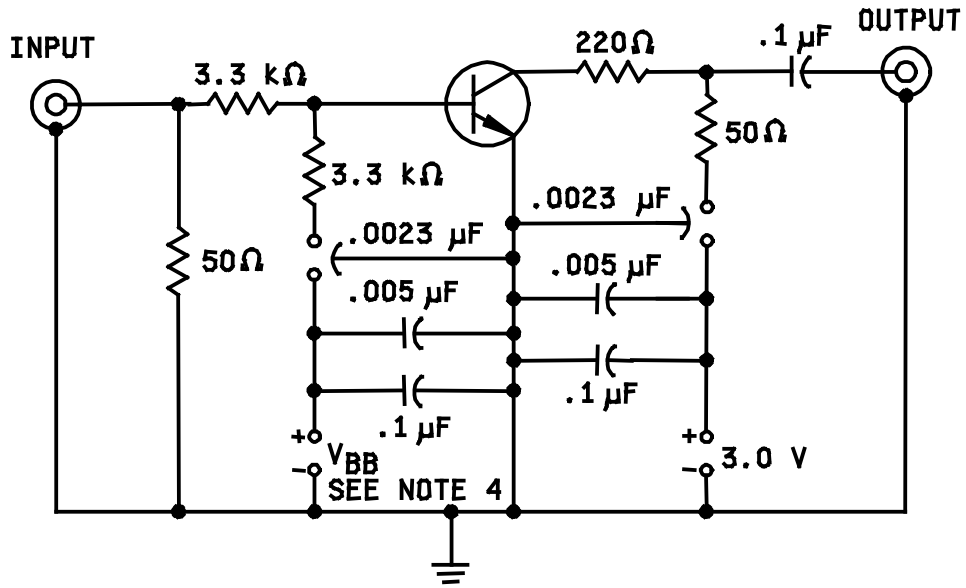

NOTES:

1. All capacitance in  $\mu\text{F}$ .
2. The input waveforms for each circuit are supplied by a pulse generator with the following characteristics:  
 $Z_{\text{OUT}} = 50\Omega$ ,  $t_r \leq 1 \text{ ns}$ ,  $\text{PW} \geq 300 \text{ ns}$ , duty cycle  $\leq 2$  percent.
3. Input and output waveforms are monitored on an oscilloscope with the following characteristics:  $t_r \leq .1 \text{ ns}$ ,  
 $Z_{\text{IN}} = 50\Omega$ .
4.  $V_{\text{BB}} = -3.0 \text{ V}$  for  $t_{\text{on}}$ ,  $+12.0 \text{ V}$  for  $t_{\text{off}}$ .

FIGURE 15. Turn-on and turn-off time test circuit.

## 5. PACKAGING

5.1 Packaging. For acquisition purposes, the packaging requirements shall be as specified in the contract or order (see 6.2). When packaging of materiel is to be performed by DoD or in-house contractor personnel, these personnel need to contact the responsible packaging activity to ascertain packaging requirements. Packaging requirements are maintained by the Inventory Control Point's packaging activities within the Military Service or Defense Agency, or within the Military Service's system commands. Packaging data retrieval is available from the managing Military Department's or Defense Agency's automated packaging files, CD-ROM products, or by contacting the responsible packaging activity.

## 6. NOTES

(This section contains information of a general or explanatory nature that may be helpful, but is not mandatory. The notes specified in MIL-PRF-19500 are applicable to this specification.)

6.1 Intended use. Semiconductors conforming to this specification are intended for original equipment design applications and logistic support of existing equipment.

6.2 Acquisition requirements. Acquisition documents should specify the following:

- a. Title, number, and date of this specification.
- b. Packaging requirements (see 5.1).
- c. Lead finish (see 3.4.1).
- d. Product assurance level and type designator.
- e. For acquisition of RHA designed devices, table II, subgroup 1 testing of group D is optional. If subgroup 1 testing is desired, it should be specified in the contract.

6.3 Qualification. With respect to products requiring qualification, awards will be made only for products which are, at the time of award of contract, qualified for inclusion in Qualified Manufacturers List (QML 19500) whether or not such products have actually been so listed by that date. The attention of the contractors is called to these requirements, and manufacturers are urged to arrange to have the products that they propose to offer to the Federal Government tested for qualification in order that they may be eligible to be awarded contracts or orders for the products covered by this specification. Information pertaining to qualification of products may be obtained from DLA Land and Maritime, ATTN: VQE, P.O. Box 3990, Columbus, OH 43218-3990 or e-mail [vqe.chief@dla.mil](mailto:vqe.chief@dla.mil). An online listing of products qualified to this specification may be found in the Qualified Products Database (QPD) at <https://assist.dla.mil>.



6.4 Suppliers of JANHC and JANKC die. The qualified JANHC and JANKC suppliers with the applicable letter version (example JANHCA2N2369A) will be identified on the QML.

Die ordering information		
PIN	Manufacturer	
	43611	34156
2N2369A	JANHCA2N2369A, JANKCA2N2369A	JANHCB2N2369A, JANKCB2N2369AM, JANANKCM2N2369A, JANKCD2N2369A, JANCP2N2369A, JANKCL2N2369A, JANKCR2N2369A, JANKCF2N2369A, JANKCG2N2369A, AND JANKCH2N2369A
2N3227		JANHCB2N3227, JANKCB2N3227, JANANKCM2N3227, JANKCD2N3227, JANCP2N3227, JANKCL2N3227, JANKCR2N2N3227, JANKCF2N3227, JANKCG2N3227, AND JANKCH2N3227

6.5 Changes from previous issue. The margins of this specification are marked with asterisks to indicate where changes from the previous issue were made. This was done as a convenience only and the Government assumes no liability whatsoever for any inaccuracies in these notations. Bidders and contractors are cautioned to evaluate the requirements of this document based on the entire content irrespective of the marginal notations and relationship to the last previous issue.

Custodians:  
 Army - CR  
 Navy - EC  
 Air Force - 85  
 NASA - NA  
 DLA - CC

Preparing activity:  
 DLA - CC  
 (Project 5961-2012-075)

Review activities:  
 Army - AR, MI, SM  
 Navy - AS, MC  
 Air Force - 19, 99

\* NOTE: The activities listed above were interested in this document as of the date of this document. Since organizations and responsibilities can change, you should verify the currency of the information above using the ASSIST Online database at <https://assist.dla.mil/>.

# Mouser Electronics

Authorized Distributor

Click to View Pricing, Inventory, Delivery & Lifecycle Information:

[Microchip:](#)

[JANSF2N2369AUA](#) [JANSF2N2369AUBC](#) [JANKCAF2N2369A](#)