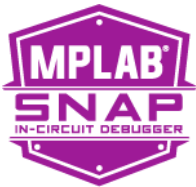

MPLAB[®] Snap In-Circuit Debugger Information Sheet

INTRODUCTION

The MPLAB[®] Snap In-Circuit Debugger (PG164100) is an ultra-low priced debugging solution for projects not requiring high-voltage programming or advanced debug features. Therefore, it supports many of Microchip's newer MCU offerings but not some legacy products. With a nominal feature set, the debugger is geared toward developers who don't require advanced features. *It is not intended for production programming.*

Note: Refer to the MPLAB[®] PICkit[™] 4 In-Circuit Debugger and the MPLAB X IDE User's Guides or online help for additional information.

- [Description](#)
- [Features](#)
- [MPLAB Snap In-Circuit Debugger Components](#)
- [Additional Items Needed](#)
- [MPLAB Snap vs. MPLAB PICkit 4 Comparison](#)
- [Pinout Information](#)
- [LEDs](#)
- [Debugger to Target Communication](#)
- [Debugger Options Selection](#)
- [Troubleshooting](#)

DESCRIPTION

The MPLAB Snap In-Circuit Debugger allows fast and easy debugging and programming using the powerful graphical user interface of MPLAB X IDE (Integrated Development Environment) or MPLAB IPE (Integrated Programming Environment). The debugger works with Microchip PIC[®], dsPIC[®] Flash, AVR[®], or DSC[®] devices. It will also work with 32-bit based microcontroller, such as SAM, CEC and PIC32 devices.

The MPLAB Snap connects to the computer using a high-speed 2.0 USB interface and connects to the target via a Microchip debug 8-pin Single In-Line (SIL) connector. The SIL connector uses two device I/O pins and the reset line to implement in-circuit debugging and In-Circuit Serial Programming[™] (ICSP[™]).

The MPLAB Snap supports advanced interfaces such as 4-wire JTAG and Serial Wire Debug with streaming Data Gateway, while being backward compatible for demo boards, headers and target systems using 2-wire JTAG and ICSP.

The debugger system executes code like an actual device because it uses the target device's built-in emulation circuitry, instead of a special debugger chip. All available features of a given device are accessible interactively and can be set and modified by the MPLAB X IDE interface.

The MPLAB Snap In-Circuit Debugger is compatible with Microsoft Windows[®] 7 or later, Linux[®] and macOS[™] platforms.

FEATURES

Features/Capabilities:

- Connects to computer via high-speed USB 2.0 (480 Mbits/s) cable
- An 8-pin SIL programming connector and the option to use various interfaces
- Programs devices using MPLAB X IDE or MPLAB IPE
- Works with many Microchip PIC, dsPIC, AVR, or DSC devices, including 32-bit microcontrollers such as SAM, CEC and PIC32 devices (refer to the device support list found on your PC, for example, C:\Program Files (X86)\Microchip\MPLABX\vx.xx\docs\Device Support.htm, where vx.xx is the version of MPLAB X IDE)
- Supports 4-wire JTAG and Serial Wire Debug
- Backward compatibility for demo boards, headers and target systems using 2-wire JTAG and ICSP (In-Circuit Serial Programming)
- Supports multiple hardware and software breakpoints, stopwatch and source code file debugging
- Debugs your application on your own hardware in real time
- Sets breakpoints based on internal events
- Debugs at full target MCU speed
- Configures pin drivers
- Adds new device support and features by installing the latest version of MPLAB X IDE (available as a free download at <http://www.microchip.com/mplabx/>)
- Indicates debugger status via the Active and Status LEDs

Performance/Speed:

- No firmware download delays incurred when switching devices
- 32-bit microcontroller using an ARM[®] Cortex[®]-M7 core running at 300 MHz

Safety:

- RoHS, CE, and China E compliant
- Supports target supply voltages from 1.2V to 5.5V +/-10%

Note: The MPLAB Snap In-Circuit Debugger is powered through its Micro-B USB connector. The target board must be powered from its own power supply.

MPLAB® Snap In-Circuit Debugger

MPLAB SNAP IN-CIRCUIT DEBUGGER COMPONENTS

The components of the MPLAB Snap In-Circuit Debugger system are:

- an 8-pin SIL connector
- a Micro-B USB connector
- two LEDs
- Emergency Recovery Jumper (not populated)

FIGURE 1-1: MPLAB® SNAP IN-CIRCUIT DEBUGGER

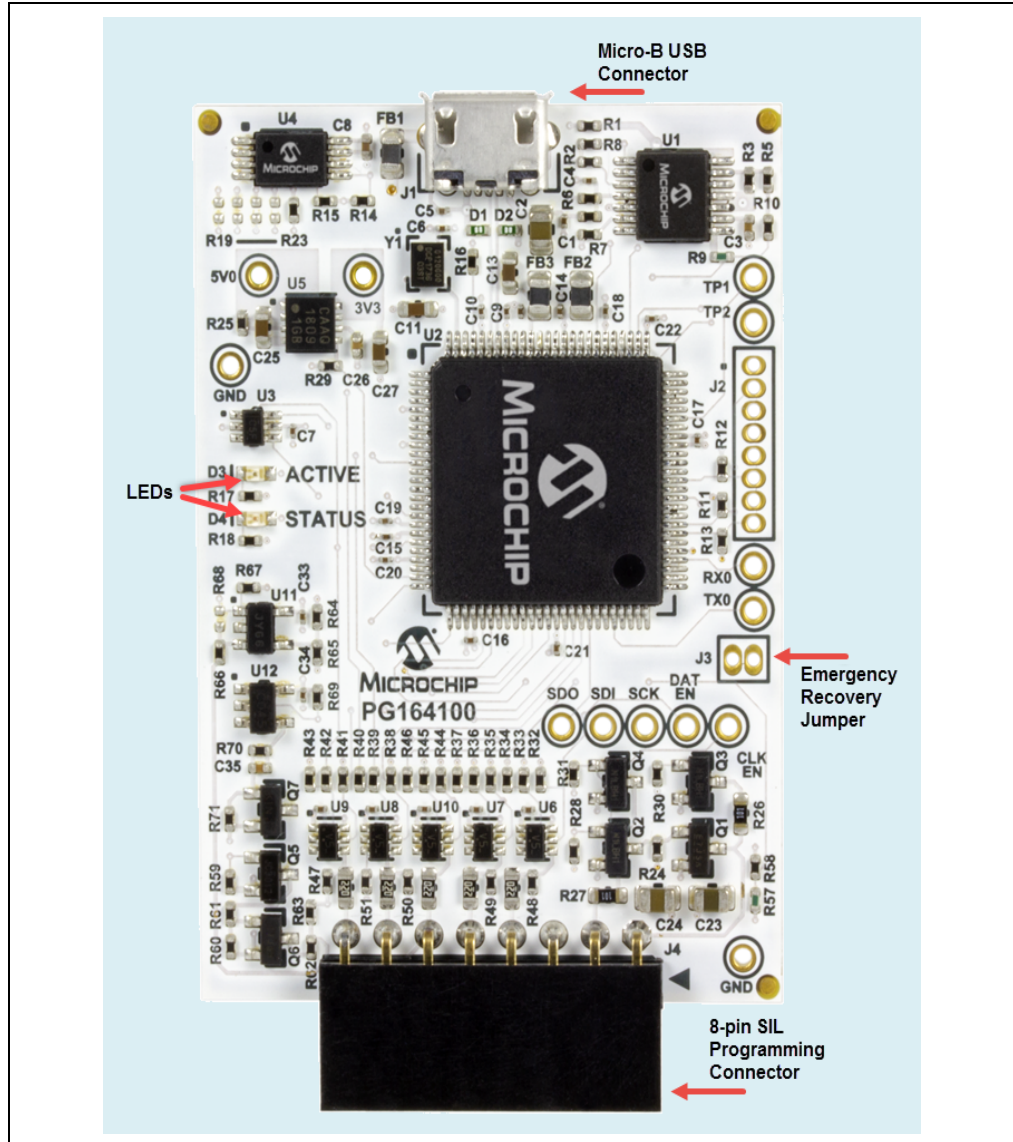

ADDITIONAL ITEMS NEEDED

To use the MPLAB Snap In-Circuit Debugger, you will need to supply:

- a full-featured Micro-B USB cable (data and power), no longer than 1.5 meter, to connect to a computer (for example, the Microchip Part Number ATUSBMICROCABLE-XPRO)
- target board
- power supply for target board

MPLAB[®] Snap In-Circuit Debugger

- any wiring interfaces or cables needed for your application, some available adapters and cables include:
 - AC164110 - RJ-11 to ICSP Adapter
 - AC002021 PM3 ICSP cable
- jumper, wire or tweezers for emergency recovery, if needed

MPLAB SNAP VS. MPLAB PICKIT 4 COMPARISON

The following table compares the MPLAB Snap to the PICKit 4.

TABLE 1-1: FEATURES COMPARISON

Feature	MPLAB Snap	MPLAB PICKit 4
Enclosure	No, exposed PCB	Yes
USB Powered	Yes	Yes
USB Speed	High	High
USB Cable supplied	No	Yes
Programmable VPP	No	Yes
Programmable VDD	No	Yes
Emulator Power	No	Yes
Power to Target	No	Yes - 50 mA
Voltage Monitoring	No	Yes
Current Sensing	No	Yes
Target Power	Yes	Yes
Target Voltage Boost	No	Yes
RGB Indicators	LED	Yes
Software Breakpoints	Yes	Yes
Breakpoints	Complex	Complex
Buffered Pin Drivers	Yes	Yes
Configurable pull-ups	No	Yes
Drag and Drop Programming	Yes	Yes
Programmer to Go	No	Yes
Production Programmer	No	Yes
Products Supported	Most Flash MCUs	All Flash MCUs
Pay-Per-Feature	No	Yes
I ² C DGI	Yes	Yes
CDD UART	Yes	Yes
SEE configuration (boot)	Yes	Yes
SPI DGI	Yes	Yes
USART DGI	Yes	Yes
USB Serialization	Yes	Yes
Recovery Method	PCB pads	Pushbutton

TABLE 1-2: INTERFACES COMPARISON

Interface	MPLAB Snap	MPLAB PICKit 4
ICSP	Yes	Yes
MIPS EJTAG 2wire	Yes	Yes

TABLE 1-2: INTERFACES COMPARISON (CONTINUED)

Interface	MPLAB Snap	MPLAB PICkit 4
MIPS EJTAG 4wire	Yes	Yes
ARM SWD	Yes	Yes
AVR32 JTAG 4wire	Yes	Yes
PDI	Yes, low voltage only	Yes
UPDI	Yes, low voltage only	Yes
UPDI/HV	No	Yes
TPI	Yes	Yes
ISP Programming	Yes	Yes
DEBUGWIRE	Yes	Yes
AWIRE	Yes	Yes

PINOUT INFORMATION

The pinouts for the MPLAB Snap are the same as the MPLAB PICkit 4 In-Circuit Debugger. Refer to the MPLAB PICkit 4 online help in MPLAB X IDE ([Help>Tool Help Contents>PICkit 4 Help](#)) for more information.

FIGURE 1-2: MPLAB SNAP PINOUTS

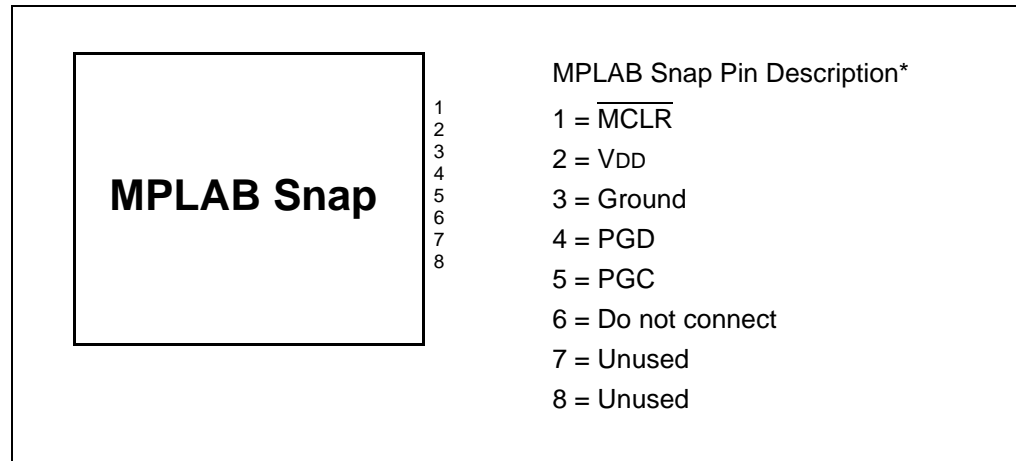

LEDS

The MPLAB Snap has two fixed color LEDs. The Active LED is green and the Status LED is yellow. The expected start-up LED sequence for the MPLAB Snap debugger is: Green - steady on, yellow off. The debugger is ready.

The LEDs have the following significance.

TABLE 1-3: NORMAL MODES LED DESCRIPTIONS

LED	Color	Description
Active, on	Green	Power is connected; debugger in standby.
Status, on (or pulsing activity)	Yellow	Debugger is busy; activity during an operation.

The following table provides LED descriptions for errors.

TABLE 1-4: ERROR LED DESCRIPTIONS

Errors	Description
Status, on 3 seconds	Bootloader problem accessing the serial EEPROM.
Status, on 10 seconds	API commands cannot be processed by the Bootloader.
Active and Status, fast blink (alternating)	A runtime exception occurred in the tool firmware.
Active and Status, fast blink (in tandem)	A runtime exception occurred in the Bootloader.

DEBUGGER TO TARGET COMMUNICATION

Note: The MPLAB X IDE software must be installed prior to connecting the MPLAB Snap In-Circuit Debugger.

The debugger is connected to the computer via a USB cable for communication and debugger power.

The debugger is connected to the target application for communication and data collection and optional debugger power.

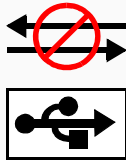
	CAUTION
	Communication Failure. Do not connect the hardware before installing the software and USB drivers.

	CAUTION
	Debugger or Target Damage. Do not change hardware connections while the debugger or target is powered.

Note: Refer to the MPLAB PICKit 4 In-Circuit Debugger online help or user's guide for information on target communication connections, debugging, requirements for debugging, programming, troubleshooting, etc.

The following figure shows a typical connection for the MPLAB Snap debugger.

FIGURE 1-3: MPLAB SNAP CONNECTIONS

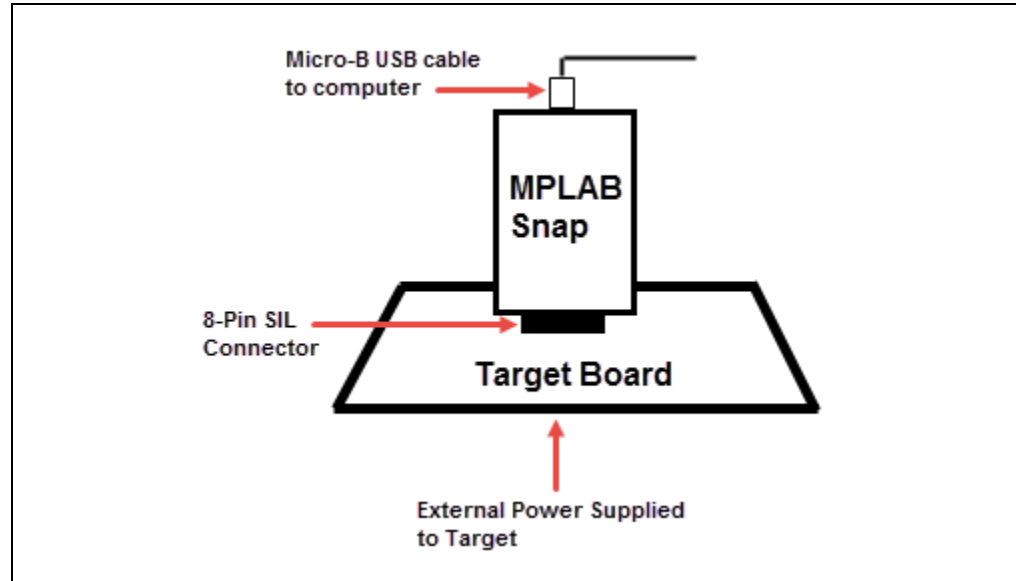

DEBUGGER OPTIONS SELECTION

The MPLAB Snap project properties available in MPLAB X IDE are a subset of the MPLAB PICKit 4 options.

Debugger options are set in the Project Properties dialog of MPLAB X IDE. Click on **Snap** under “Categories” to display the “Options for Snap” (see Figure 1-4). Use the “Options categories” drop-down list to select various options. Click on an option name to see its description in the Option Description box below. Click to the right of an option name to select or change it.

Note: The available option categories and the options within those categories are dependent on the device you have selected.

FIGURE 1-4: MPLAB X IDE OPTIONS FOR MPLAB SNAP

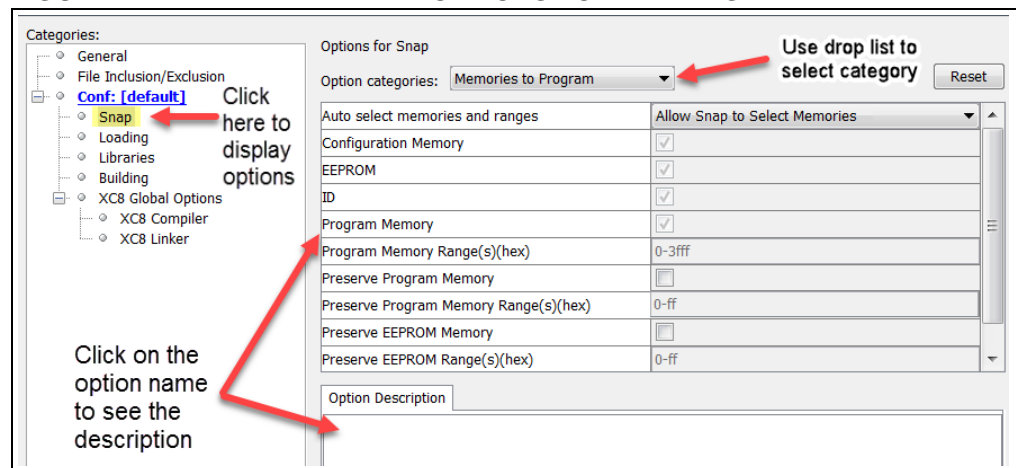

After setting the options, click **Apply** or **OK**. Also click the Refresh Debug Tool status icon  in the MPLAB X IDE dashboard display to update any changes made.

For the MPLAB IPE, the options for MPLAB Snap are located in [Settings>Advance Mode>Settings](#). Refer to MPLAB IPE online help for more information.

The possible option categories may include:

- Memories to Program
- Debug Options
- Program Options
- Freeze Peripherals
- Power
- Firmware

TROUBLESHOOTING

If you are having problems with MPLAB Snap In-Circuit Debugger operation, start here.

Refer to the MPLAB PICKit 4 online help section on Troubleshooting First Steps. From there you can navigate to “Some Questions to Answer First” and “Top Reasons Why You Can’t Debug.” For general issues, invoking the bootloader mode and the emergency boot firmware recovery, see the following sections.

General

1. It is possible the error was a one-time event. Try the operation again.
2. There may be a problem programming in general. As a test, switch to Run mode in MPLAB X IDE using the  icon and program the target with the simplest application possible (e.g., a program to blink an LED). If the program will not run, then you know that something is wrong with the target setup.
3. It is possible that the target device has been damaged in some way (e.g., over current.) Development environments are notoriously hostile to components. Consider trying another target board.
4. Microchip Technology Inc. offers demonstration boards to support most of its microcontrollers. Consider using one of these applications, which are known to work, to verify correct MPLAB Snap In-Circuit Debugger functionality.
5. Review debugger setup to ensure proper application setup. For more information, see the “Operation” section of the MPLAB PICKit 4 help or PDF.
6. Your program speed may be set too high for your circuit. In MPLAB X IDE, go to [File>Project Properties](#), select **Snap** in Categories, then **Program Options** in Option categories, **Program Speed** and select a slower speed from the drop-down menu. The default is Normal. In MPLAB IPE, the Program Speed option can be found in the Advanced Mode, Settings tab.
7. There may be certain situations where the debugger is not operating properly and needs to be reprogrammed. See the following section.

The Hardware Tool Emergency Boot Firmware Recovery Utility

WARNING

Only use this utility to restore hardware tool boot firmware to its factory state. Use only if your hardware tool no longer functions on any machine.

The debugger may need to be forced into recovery boot mode (reprogrammed) in rare situations. For example, if none of the LEDs are lit when the debugger is connected to the computer.

YOU MUST USE MPLAB X IDE V5.05 OR GREATER TO USE THE EMERGENCY RECOVERY UTILITY FOR THE MPLAB SNAP.

Carefully follow the instructions found in MPLAB X IDE under the main menu option *Debug>Hardware Tool Emergency Boot Firmware Recovery*. After the Warning screen, select **MPLAB Snap**.

FIGURE 1-5: SELECTING EMERGENCY UTILITY

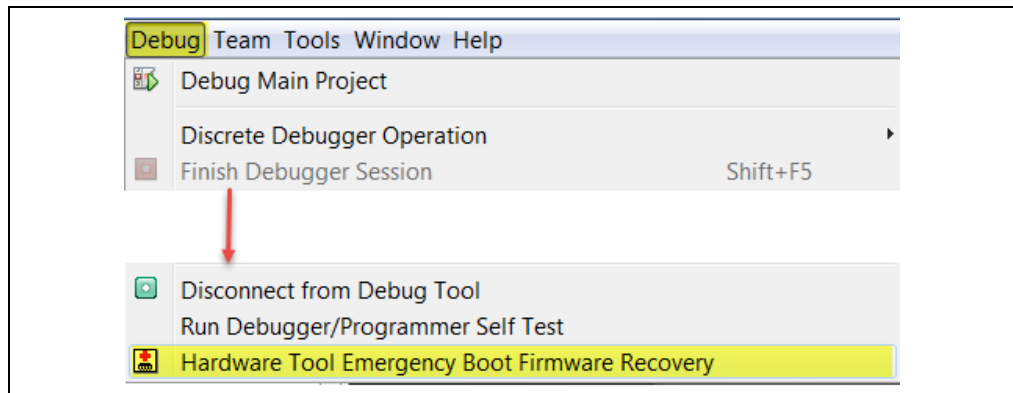
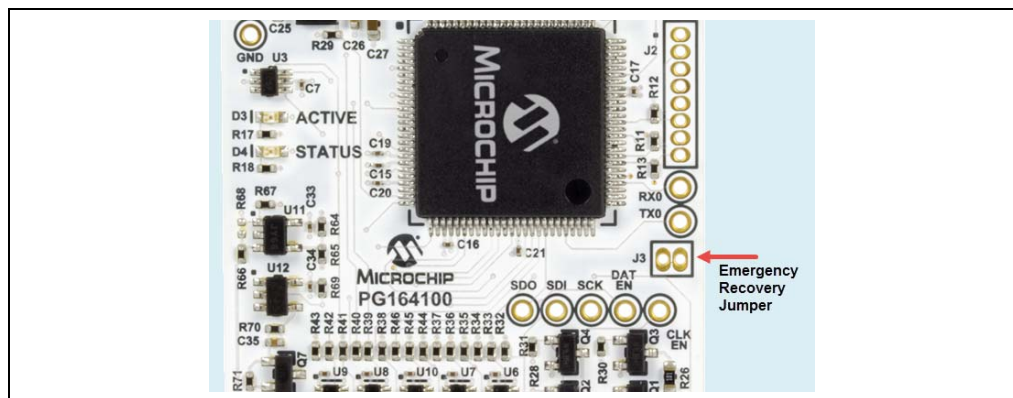

Figure 1-6 shows where the emergency recovery jumper is located on the board.

FIGURE 1-6: EMERGENCY RECOVERY JUMPER



If the procedure was successful, the recovery wizard displays a success screen. The MPLAB Snap will now be operational and able to communicate with the MPLAB X IDE. If the procedure fails, try it again. If it fails a second time, contact Microchip Support at <http://support.microchip.com>.

NOTES:

Note the following details of the code protection feature on Microchip devices:

- Microchip products meet the specification contained in their particular Microchip Data Sheet.
- Microchip believes that its family of products is one of the most secure families of its kind on the market today, when used in the intended manner and under normal conditions.
- There are dishonest and possibly illegal methods used to breach the code protection feature. All of these methods, to our knowledge, require using the Microchip products in a manner outside the operating specifications contained in Microchip's Data Sheets. Most likely, the person doing so is engaged in theft of intellectual property.
- Microchip is willing to work with the customer who is concerned about the integrity of their code.
- Neither Microchip nor any other semiconductor manufacturer can guarantee the security of their code. Code protection does not mean that we are guaranteeing the product as “unbreakable.”

Code protection is constantly evolving. We at Microchip are committed to continuously improving the code protection features of our products. Attempts to break Microchip's code protection feature may be a violation of the Digital Millennium Copyright Act. If such acts allow unauthorized access to your software or other copyrighted work, you may have a right to sue for relief under that Act.

Information contained in this publication regarding device applications and the like is provided only for your convenience and may be superseded by updates. It is your responsibility to ensure that your application meets with your specifications. MICROCHIP MAKES NO REPRESENTATIONS OR WARRANTIES OF ANY KIND WHETHER EXPRESS OR IMPLIED, WRITTEN OR ORAL, STATUTORY OR OTHERWISE, RELATED TO THE INFORMATION, INCLUDING BUT NOT LIMITED TO ITS CONDITION, QUALITY, PERFORMANCE, MERCHANTABILITY OR FITNESS FOR PURPOSE. Microchip disclaims all liability arising from this information and its use. Use of Microchip devices in life support and/or safety applications is entirely at the buyer's risk, and the buyer agrees to defend, indemnify and hold harmless Microchip from any and all damages, claims, suits, or expenses resulting from such use. No licenses are conveyed, implicitly or otherwise, under any Microchip intellectual property rights unless otherwise stated.

AMBA, Arm, Arm7, Arm7TDMI, Arm9, Arm11, Artisan, big.LITTLE, Cordio, CoreLink, CoreSight, Cortex, Design-Start, DynamIQ, Jazelle, Keil, Mali, Mbed, Mbed Enabled, NEON, POP, RealView, SecurCore, Socrates, Thumb, TrustZone, ULINK, ULINK2, ULINK-ME, ULINK-PLUS, ULINKpro, µVision, Versatile are trademarks or registered trademarks of Arm Limited (or its subsidiaries) in the US and/or elsewhere.



Microchip received ISO/TS-16949:2009 certification for its worldwide headquarters, design and wafer fabrication facilities in Chandler and Tempe, Arizona; Gresham, Oregon and design centers in California and India. The Company's quality system processes and procedures are for its PIC® MCUs and dsPIC® DSCs, KEELoC® code hopping devices, Serial EEPROMs, microperipherals, nonvolatile memory and analog products. In addition, Microchip's quality system for the design and manufacture of development systems is ISO 9001:2000 certified.

**QUALITY MANAGEMENT SYSTEM
CERTIFIED BY DNV
= ISO/TS 16949 =**

Trademarks

The Microchip name and logo, the Microchip logo, AnyRate, AVR, AVR logo, AVR Freaks, BitCloud, chipKIT, chipKIT logo, CryptoMemory, CryptoRF, dsPIC, FlashFlex, flexPWR, Heldo, JukeBlox, KeeLoq, Klear, LANCheck, LINK MD, maXStylus, maXTouch, MediaLB, megaAVR, MOST, MOST logo, MPLAB, OptoLyzer, PIC, picoPower, PICSTART, PIC32 logo, Prochip Designer, QTouch, SAM-BA, SpyNIC, SST, SST Logo, SuperFlash, tinyAVR, UNI/O, and XMEGA are registered trademarks of Microchip Technology Incorporated in the U.S.A. and other countries.

ClockWorks, The Embedded Control Solutions Company, EtherSynch, Hyper Speed Control, HyperLight Load, IntelliMOS, mTouch, Precision Edge, and Quiet-Wire are registered trademarks of Microchip Technology Incorporated in the U.S.A.

Adjacent Key Suppression, AKS, Analog-for-the-Digital Age, Any Capacitor, AnyIn, AnyOut, BodyCom, CodeGuard, CryptoAuthentication, CryptoAutomotive, CryptoCompanion, CryptoController, dsPICDEM, dsPICDEM.net, Dynamic Average Matching, DAM, ECAN, EtherGREEN, In-Circuit Serial Programming, ICSP, INICnet, Inter-Chip Connectivity, JitterBlocker, KlearNet, KlearNet logo, memBrain, Mindi, MiWi, motorBench, MPASM, MPF, MPLAB Certified logo, MPLIB, MPLINK, MultiTRAK, NetDetach, Omniscient Code Generation, PICDEM, PICDEM.net, PICkit, PICtail, PowerSmart, PureSilicon, QMatrix, REAL ICE, Ripple Blocker, SAM-ICE, Serial Quad I/O, SMART-I.S., SQI, SuperSwitcher, SuperSwitcher II, Total Endurance, TSHARC, USBCheck, VariSense, ViewSpan, WiperLock, Wireless DNA, and ZENA are trademarks of Microchip Technology Incorporated in the U.S.A. and other countries.

SQTP is a service mark of Microchip Technology Incorporated in the U.S.A.

Silicon Storage Technology is a registered trademark of Microchip Technology Inc. in other countries.

GestIC is a registered trademark of Microchip Technology Germany II GmbH & Co. KG, a subsidiary of Microchip Technology Inc., in other countries.

All other trademarks mentioned herein are property of their respective companies.

© 2018, Microchip Technology Incorporated, All Rights Reserved.
ISBN: 978-1-5224-3335-4



MICROCHIP

Worldwide Sales and Service

AMERICAS

Corporate Office
2355 West Chandler Blvd.
Chandler, AZ 85224-6199
Tel: 480-792-7200
Fax: 480-792-7277
Technical Support:
<http://www.microchip.com/support>
Web Address:
www.microchip.com

Atlanta

Duluth, GA
Tel: 678-957-9614
Fax: 678-957-1455

Austin, TX

Tel: 512-257-3370

Boston

Westborough, MA
Tel: 774-760-0087
Fax: 774-760-0088

Chicago

Itasca, IL
Tel: 630-285-0071
Fax: 630-285-0075

Dallas

Addison, TX
Tel: 972-818-7423
Fax: 972-818-2924

Detroit

Novi, MI
Tel: 248-848-4000

Houston, TX

Tel: 281-894-5983

Indianapolis

Noblesville, IN
Tel: 317-773-8323
Fax: 317-773-5453
Tel: 317-536-2380

Los Angeles

Mission Viejo, CA
Tel: 949-462-9523
Fax: 949-462-9608
Tel: 951-273-7800

Raleigh, NC

Tel: 919-844-7510

New York, NY

Tel: 631-435-6000

San Jose, CA

Tel: 408-735-9110
Tel: 408-436-4270

Canada - Toronto

Tel: 905-695-1980
Fax: 905-695-2078

ASIA/PACIFIC

Australia - Sydney
Tel: 61-2-9868-6733

China - Beijing
Tel: 86-10-8569-7000

China - Chengdu
Tel: 86-28-8665-5511

China - Chongqing
Tel: 86-23-8980-9588

China - Dongguan
Tel: 86-769-8702-9880

China - Guangzhou
Tel: 86-20-8755-8029

China - Hangzhou
Tel: 86-571-8792-8115

China - Hong Kong SAR
Tel: 852-2943-5100

China - Nanjing
Tel: 86-25-8473-2460

China - Qingdao
Tel: 86-532-8502-7355

China - Shanghai
Tel: 86-21-3326-8000

China - Shenyang
Tel: 86-24-2334-2829

China - Shenzhen
Tel: 86-755-8864-2200

China - Suzhou
Tel: 86-186-6233-1526

China - Wuhan
Tel: 86-27-5980-5300

China - Xian
Tel: 86-29-8833-7252

China - Xiamen
Tel: 86-592-2388138

China - Zhuhai
Tel: 86-756-3210040

ASIA/PACIFIC

India - Bangalore
Tel: 91-80-3090-4444

India - New Delhi
Tel: 91-11-4160-8631

India - Pune
Tel: 91-20-4121-0141

Japan - Osaka
Tel: 81-6-6152-7160

Japan - Tokyo
Tel: 81-3-6880-3770

Korea - Daegu
Tel: 82-53-744-4301

Korea - Seoul
Tel: 82-2-554-7200

Malaysia - Kuala Lumpur
Tel: 60-3-7651-7906

Malaysia - Penang
Tel: 60-4-227-8870

Philippines - Manila
Tel: 63-2-634-9065

Singapore
Tel: 65-6334-8870

Taiwan - Hsin Chu
Tel: 886-3-577-8366

Taiwan - Kaohsiung
Tel: 886-7-213-7830

Taiwan - Taipei
Tel: 886-2-2508-8600

Thailand - Bangkok
Tel: 66-2-694-1351

Vietnam - Ho Chi Minh
Tel: 84-28-5448-2100

EUROPE

Austria - Wels
Tel: 43-7242-2244-39
Fax: 43-7242-2244-393

Denmark - Copenhagen
Tel: 45-4450-2828
Fax: 45-4485-2829

Finland - Espoo
Tel: 358-9-4520-820

France - Paris
Tel: 33-1-69-53-63-20
Fax: 33-1-69-30-90-79

Germany - Garching
Tel: 49-8931-9700

Germany - Haan
Tel: 49-2129-3766400

Germany - Heilbronn
Tel: 49-7131-67-3636

Germany - Karlsruhe
Tel: 49-721-625370

Germany - Munich
Tel: 49-89-627-144-0
Fax: 49-89-627-144-44

Germany - Rosenheim
Tel: 49-8031-354-560

Israel - Ra'anana
Tel: 972-9-744-7705

Italy - Milan
Tel: 39-0331-742611
Fax: 39-0331-466781

Italy - Padova
Tel: 39-049-7625286

Netherlands - Drunen
Tel: 31-416-690399
Fax: 31-416-690340

Norway - Trondheim
Tel: 47-7289-7561

Poland - Warsaw
Tel: 48-22-3325737

Romania - Bucharest
Tel: 40-21-407-87-50

Spain - Madrid
Tel: 34-91-708-08-90
Fax: 34-91-708-08-91

Sweden - Gothenberg
Tel: 46-31-704-60-40

Sweden - Stockholm
Tel: 46-8-5090-4654

UK - Wokingham
Tel: 44-118-921-5800
Fax: 44-118-921-5820

Mouser Electronics

Authorized Distributor

Click to View Pricing, Inventory, Delivery & Lifecycle Information:

[Microchip:](#)

[PG164100](#)