

## Low-Power Operational Amplifier

### Features

- Small Footprint SOT-23-5 Package
- Guaranteed 2.7V, 3V, 5V, and 12V Performance
- 500 kHz Gain-Bandwidth
- 0.01% Total Harmonic Distortion at 10 kHz (5V, 2 k $\Omega$ )
- 0.5 mA Typical Supply Current at 5V

### Applications

- Mobile Communications, Cellular Phones, Pagers
- Battery-Powered Instrumentation
- PCMCIA, USB
- Portable Computers and PDAs

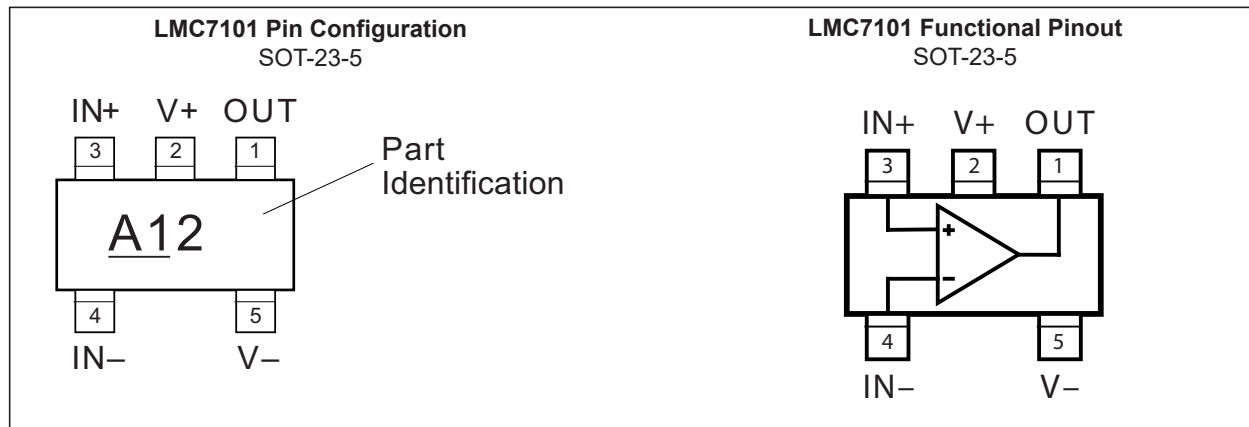
### General Description

The LMC7101 is a high-performance, low-power, operational amplifier that is pin-for-pin compatible with the National Semiconductor LMC7101. It features rail-to-rail input and output performance in the IttyBitty SOT-23-5 package.

The LMC7101 is a 500 kHz gain-bandwidth amplifier designed to operate from 2.7V to 12V single-ended power supplies with guaranteed performance at supply voltages of 2.7V, 3V, 5V, and 12V.

This op amp's input common-mode range includes ground and extends 300 mV beyond the supply rails. For example, the common-mode range is  $-0.3V$  to  $+5.3V$  with a 5V supply.

### Package Type



# LMC7101

---

## 1.0 ELECTRICAL CHARACTERISTICS

### Absolute Maximum Ratings † ††

Supply Voltage, ( $V_{V+} - V_{V-}$ ) .....	+15V
Differential Input Voltage, ( $V_{IN+} - V_{IN-}$ ) .....	$\pm(V_{V+} - V_{V-})$
I/O Pin Voltage, ( $V_{IN}, V_{OUT}$ ) (Note 1) .....	$V_{V+} + 0.3V$ to $V_{V-} - 0.3V$
ESD Protection, (Note 2) .....	$\pm 2$ kV HBM

### Operating Ratings††

Supply Voltage, $V_{IN} - V_{V-}$ .....	2.7V to 12V
Max. Power Dissipation .....	(Note 3)

**† Notice:** Stresses above those listed under “Absolute Maximum Ratings” may cause permanent damage to the device. This is a stress rating only and functional operation of the device at those or any other conditions above those indicated in the operational sections of this specification is not intended. Exposure to maximum rating conditions for extended periods may affect device reliability.

**†† Notice:** Absolute maximum ratings indicate limits beyond which damage to the component may occur. Electrical specifications do not apply when operating the device outside its recommended operating ratings.

**Note 1:** I/O pin voltage is any external voltage to which an input or output is referenced.

**2:** Human body model, 1.5 k $\Omega$  in series with 100 pF.

**3:** The maximum allowable power dissipation is a function of the maximum junction temperature,  $T_{J(max)}$ ; the junction-to-ambient thermal resistance,  $\theta_{JA}$ ; and the ambient temperature,  $T_A$ . The maximum allowable power dissipation at any ambient temperature is calculated using:  $P_D = (T_{J(max)} - T_A) \div \theta_{JA}$ . Exceeding the maximum allowable power dissipation will result in excessive die temperature.

## LM7101A 2.7V DC ELECTRICAL CHARACTERISTICS

**Electrical Characteristics:** Unless otherwise indicated,  $V_+ = +2.7V$ ,  $V_- = 0V$ ,  $V_{CM} = V_{OUT} = V_+/2$ ;  $R_L = 1\text{ M}\Omega$ ;  $T_J = +25^\circ\text{C}$ .

Parameters	Symbol	Min.	Typ.	Max.	Units	Conditions
Input Offset Voltage	$V_{OS}$	—	0.11	6	mV	—
Input Offset Voltage Average Drift	$TCV_{OS}$	—	1.0	—	$\mu\text{V}/^\circ\text{C}$	—
Input Bias Current	$I_B$	—	1.0	64	pA	$-40^\circ\text{C} \leq T_J \leq +85^\circ\text{C}$
Input Offset Current	$I_{OS}$	—	0.5	32		$-40^\circ\text{C} \leq T_J \leq +85^\circ\text{C}$
Input Resistance	$R_{IN}$	—	>1	—	T $\Omega$	—
Common-Mode Rejection Ratio	CMRR	50	70	—	dB	$0V \leq V_{CM} \leq 2.7V$ , <a href="#">Note 1</a>
Input Common Mode Voltage	$V_{CM}$	—	-0.3	0.0	V	Input LOW, CMRR $\geq$ 50 dB
		2.7	3.0	—	V	Input HIGH, CMRR $\geq$ 50 dB
Power Supply Rejection Ratio	PSRR	50	60	—	dB	$V_+ = 1.35V$ to $1.65V$ , $V_- = -1.35V$ to $-1.65V$ , $V_{CM} = 0V$
Common-Mode Input Capacitance	$C_{IN}$	—	3	—	pF	—
Output Swing	$V_O$	2.64	2.699	—	V	Output HIGH, $R_L = 10\text{ k}\Omega$
		—	0.001	0.06	V	Output LOW, $R_L = 10\text{ k}\Omega$
		2.6	2.692	—	V	Output HIGH, $R_L = 2\text{ k}\Omega$
		—	0.008	0.1	V	Output LOW, $R_L = 2\text{ k}\Omega$
Supply Current	$I_S$	—	0.5	0.81	mA	—
		—	—	0.95	mA	$-40^\circ\text{C} \leq T_J \leq +85^\circ\text{C}$
Slew Rate	SR	—	0.4	—	V/ $\mu\text{s}$	—
Gain-Bandwidth Product	GBW	—	0.5	—	MHz	—

**Note 1:** Common-mode performance tends to follow the typical value. Minimum value limits reflect performance only near the supply rails.

# LMC7101

## LM7101B 2.7V DC ELECTRICAL CHARACTERISTICS

**Electrical Characteristics:** Unless otherwise indicated,  $V_+ = +2.7V$ ,  $V_- = 0V$ ,  $V_{CM} = V_{OUT} = V_+/2$ ;  $R_L = 1M\Omega$ ;  $T_J = +25^\circ C$ . **Bold** values indicate  $-40^\circ C \leq T_J \leq +85^\circ C$ .

Parameters	Symbol	Min.	Typ.	Max.	Units	Conditions
Input Offset Voltage	$V_{OS}$	—	0.11	9	mV	—
Input Offset Voltage Average Drift	$TCV_{OS}$	—	1.0	—	$\mu V/^\circ C$	—
Input Bias Current	$I_B$	—	1.0	64	pA	$-40^\circ C \leq T_J \leq +85^\circ C$
Input Offset Current	$I_{OS}$	—	0.5	32	pA	$-40^\circ C \leq T_J \leq +85^\circ C$
Input Resistance	$R_{IN}$	—	>1	—	$T\Omega$	—
Common-Mode Rejection Ratio	CMRR	50	70	—	dB	$0V \leq V_{CM} \leq 2.7V$ , <b>Note 1</b>
Input Common Mode Voltage	$V_{CM}$	—	-0.3	0.0	V	Input LOW, CMRR $\geq 50$ dB
		2.7	3.0	—	V	Input HIGH, CMRR $\geq 50$ dB
Power Supply Rejection Ratio	PSRR	45	60	—	dB	$V_+ = 1.35V$ to $1.65V$ , $V_- = -1.35V$ to $-1.65V$ , $V_{CM} = 0V$
Common-Mode Input Capacitance	$C_{IN}$	—	3	—	pF	—
Output Swing	$V_O$	2.64	2.699	—	V	Output HIGH, $R_L = 10\ k\Omega$
		—	0.001	0.06	V	Output LOW, $R_L = 10\ k\Omega$
		2.6	2.692	—	V	Output HIGH, $R_L = 2\ k\Omega$
		—	0.008	0.1	V	Output LOW, $R_L = 2\ k\Omega$
Supply Current	$I_S$	—	0.5	0.81	mA	—
		—	—	0.95	mA	$-40^\circ C \leq T_J \leq +85^\circ C$
Slew Rate	SR	—	0.4	—	$V/\mu s$	—
Gain-Bandwidth Product	GBW	—	0.5	—	MHz	—

**Note 1:** Common-mode performance tends to follow the typical value. Minimum value limits reflect performance only near the supply rails.

## LM7101A 3.0V DC ELECTRICAL CHARACTERISTICS

**Electrical Characteristics:** Unless otherwise indicated,  $V_+ = +3.0V$ ,  $V_- = 0V$ ,  $V_{CM} = V_{OUT} = V_+/2$ ;  $R_L = 1\text{ M}\Omega$ ;  $T_J = +25^\circ\text{C}$ .

Parameters	Symbol	Min.	Typ.	Max.	Units	Conditions
Input Offset Voltage	$V_{OS}$	—	0.11	4	mV	—
		—	0.11	6	mV	$-40^\circ\text{C} \leq T_J \leq +85^\circ\text{C}$
Input Offset Voltage Average Drift	$TCV_{OS}$	—	1.0	—	$\mu\text{V}/^\circ\text{C}$	—
Input Bias Current	$I_B$	—	1.0	64	pA	$-40^\circ\text{C} \leq T_J \leq +85^\circ\text{C}$
Input Offset Current	$I_{OS}$	—	0.5	32	pA	$-40^\circ\text{C} \leq T_J \leq +85^\circ\text{C}$
Input Resistance	$R_{IN}$	—	>1	—	$\text{T}\Omega$	—
Common-Mode Rejection Ratio	CMRR	60	74	—	dB	$0V \leq V_{CM} \leq 3.0V$ , <a href="#">Note 1</a>
Input Common Mode Voltage	$V_{CM}$	—	-0.3	0.0	V	Input LOW, CMRR $\geq 50$ dB
		3.0	3.3	—	V	Input HIGH, CMRR $\geq 50$ dB
Power Supply Rejection Ratio	PSRR	68	80	—	dB	$V_+ = 1.5V$ to $6.0V$ , $V_- = -1.5V$ to $-6.0V$ , $V_{CM} = 0V$
Common-Mode Input Capacitance	$C_{IN}$	—	3	—	pF	—
Output Swing	$V_{OUT}$	2.9	2.992	—	V	Output HIGH, $R_L = 2\text{ k}\Omega$
		—	0.008	0.1	V	Output LOW, $R_L = 2\text{ k}\Omega$
		2.85	2.973	—	V	Output HIGH, $R_L = 600\Omega$
		—	0.027	0.15	V	Output LOW, $R_L = 600\Omega$
Supply Current	$I_S$	—	0.5	0.81	mA	—
		—	—	0.95	mA	$-40^\circ\text{C} \leq T_J \leq +85^\circ\text{C}$

**Note 1:** Common-mode performance tends to follow the typical value. Minimum value limits reflect performance only near the supply rails.

# LMC7101

## LM7101B 3.0V DC ELECTRICAL CHARACTERISTICS

**Electrical Characteristics:** Unless otherwise indicated,  $V_+ = +3.0V$ ,  $V_- = 0V$ ,  $V_{CM} = V_{OUT} = V_+/2$ ;  $R_L = 1\text{ M}\Omega$ ;  $T_J = +25^\circ\text{C}$ .

Parameters	Symbol	Min.	Typ.	Max.	Units	Conditions
Input Offset Voltage	$V_{OS}$	—	0.11	7	mV	—
		—	0.11	9	mV	$-40^\circ\text{C} \leq T_J \leq +85^\circ\text{C}$
Input Offset Voltage Average Drift	$TCV_{OS}$	—	1.0	—	$\mu\text{V}/^\circ\text{C}$	—
Input Bias Current	$I_B$	—	1.0	64	pA	$-40^\circ\text{C} \leq T_J \leq +85^\circ\text{C}$
Input Offset Current	$I_{OS}$	—	0.5	32	pA	$-40^\circ\text{C} \leq T_J \leq +85^\circ\text{C}$
Input Resistance	$R_{IN}$	—	>1	—	$\text{T}\Omega$	—
Common-Mode Rejection Ratio	CMRR	60	74	—	dB	$0V \leq V_{CM} \leq 3.0V$ , <a href="#">Note 1</a>
Input Common Mode Voltage	$V_{CM}$	—	-0.3	0.0	V	Input LOW, CMRR $\geq 50$ dB
		3.0	3.3	—	V	Input HIGH, CMRR $\geq 50$ dB
Power Supply Rejection Ratio	PSRR	60	80	—	dB	$V_+ = 1.5V$ to $6.0V$ , $V_- = -1.5V$ to $-6.0V$ , $V_{CM} = 0$
Common-Mode Input Capacitance	$C_{IN}$	—	3	—	pF	—
Output Swing	$V_O$	2.9	2.992	—	V	Output HIGH, $R_L = 2\text{ k}\Omega$
		—	0.008	0.1	V	Output LOW, $R_L = 2\text{ k}\Omega$
		2.85	2.973	—	V	Output HIGH, $R_L = 600\Omega$
		—	0.027	0.15	V	Output LOW, $R_L = 600\Omega$
Supply Current	$I_S$	—	0.5	0.81	mA	—
		—	—	0.95	mA	$-40^\circ\text{C} \leq T_J \leq +85^\circ\text{C}$

**Note 1:** Common-mode performance tends to follow the typical value. Minimum value limits reflect performance only near the supply rails.

## LM7101A 5.0V DC ELECTRICAL CHARACTERISTICS

**Electrical Characteristics:** Unless otherwise indicated,  $V_+ = +5.0V$ ,  $V_- = 0V$ ,  $V_{CM} = 1.5V$ ,  $V_{OUT} = V_+/2$ ;  $R_L = 1\ M\Omega$ ;  $T_J = +25^\circ C$ .

Parameters	Symbol	Min.	Typ.	Max.	Units	Conditions
Input Offset Voltage	$V_{OS}$	—	0.11	3	mV	—
		—	0.11	5	mV	$-40^\circ C \leq T_J \leq +85^\circ C$
Input Offset Voltage Average Drift	$TCV_{OS}$	—	1.0	—	$\mu V/^\circ C$	—
Input Bias Current	$I_B$	—	1.0	64	pA	$-40^\circ C \leq T_J \leq +85^\circ C$
Input Offset Current	$I_{OS}$	—	0.5	32	pA	$-40^\circ C \leq T_J \leq +85^\circ C$
Input Resistance	$R_{IN}$	—	>1	—	$T\Omega$	—
Common-Mode Rejection Ratio	CMRR	60	82	—	dB	$0V \leq V_{CM} \leq 5V$ , <a href="#">Note 1</a>
		55	—	—	dB	$0V \leq V_{CM} \leq 5V$ , <a href="#">Note 1</a> , $-40^\circ C \leq T_J \leq +85^\circ C$
Input Common Mode Voltage	$V_{CM}$	—	-0.3	-0.20	V	Input LOW, CMRR $\geq 50$ dB
		—	—	0.00	V	Input LOW, CMRR $\geq 50$ dB, $-40^\circ C \leq T_J \leq +85^\circ C$
		5.20	5.3	—	V	Input HIGH, CMRR $\geq 50$ dB
		5.0	—	—	V	Input HIGH, CMRR $\geq 50$ dB, $-40^\circ C \leq T_J \leq +85^\circ C$
Positive Power Supply Rejection Ratio	+PSRR	70	82	—	dB	$V_+ = 5V$ to $12V$ , $V_- = 0V$ , $V_{OUT} = 1.5V$
		65	—	—	db	$V_+ = 5V$ to $12V$ , $V_- = 0V$ , $V_{OUT} = 1.5V$ , $-40^\circ C \leq T_J \leq +85^\circ C$
Negative Power Supply Rejection Ratio	-PSRR	70	82	—	dB	$V_+ = 0V$ , $V_- = -5V$ to $-12V$ , $V_{OUT} = -1.5V$
		65	—	—	dB	$V_+ = 0V$ , $V_- = -5V$ to $-12V$ , $V_{OUT} = -1.5V$ , $-40^\circ C \leq T_J \leq +85^\circ C$
Common-Mode Input Capacitance	$C_{IN}$	—	3	—	pF	—

**Note 1:** Common-mode performance tends to follow the typical value. Minimum value limits reflect performance only near the supply rails.

**2:** Continuous short circuit may exceed absolute maximum  $T_J$  under some conditions.

# LMC7101

## LM7101A 5.0V DC ELECTRICAL CHARACTERISTICS (CONTINUED)

**Electrical Characteristics:** Unless otherwise indicated,  $V_+ = +5.0V$ ,  $V_- = 0V$ ,  $V_{CM} = 1.5V$ ,  $V_{OUT} = V_+/2$ ;  $R_L = 1\text{ M}\Omega$ ;  $T_J = +25^\circ\text{C}$ .

Parameters	Symbol	Min.	Typ.	Max.	Units	Conditions
Output Swing	$V_{OUT}$	4.9	4.989	—	V	Output HIGH, $R_L = 2\text{ k}\Omega$
		4.85	—	—	V	Output HIGH, $R_L = 2\text{ k}\Omega$ , $-40^\circ\text{C} \leq T_J \leq +85^\circ\text{C}$
		—	0.011	0.1	V	Output LOW, $R_L = 2\text{ k}\Omega$
		—	—	0.15	V	Output LOW, $R_L = 2\text{ k}\Omega$ , $-40^\circ\text{C} \leq T_J \leq +85^\circ\text{C}$
		4.9	4.963	—	V	Output HIGH, $R_L = 600\Omega$
		4.8	—	—	V	Output HIGH, $R_L = 600\Omega$ , $-40^\circ\text{C} \leq T_J \leq +85^\circ\text{C}$
		—	0.037	0.1	V	Output LOW, $R_L = 600\Omega$
		—	—	0.2	V	Output LOW, $R_L = 600\Omega$ , $-40^\circ\text{C} \leq T_J \leq +85^\circ\text{C}$
Output Short Supply Current Note 2	$I_{SC}$	120	200	—	mA	Sourcing ( $V_{OUT} = 0V$ ) or Sinking ( $V_{OUT} = 5V$ )
		80	—	—	mA	Sourcing ( $V_{OUT} = 0V$ ) or Sinking ( $V_{OUT} = 5V$ ), $-40^\circ\text{C} \leq T_J \leq +85^\circ\text{C}$
Supply Current	$I_S$	—	0.5	0.85	mA	—
		—	—	1.0	mA	$-40^\circ\text{C} \leq T_J \leq +85^\circ\text{C}$
<p><b>Note 1:</b> Common-mode performance tends to follow the typical value. Minimum value limits reflect performance only near the supply rails.</p> <p><b>2:</b> Continuous short circuit may exceed absolute maximum <math>T_J</math> under some conditions.</p>						



## LM7101B 5.0V DC ELECTRICAL CHARACTERISTICS

**Electrical Characteristics:** Unless otherwise indicated,  $V_+ = +5.0V$ ,  $V_- = 0V$ ,  $V_{CM} = 1.5V$ ,  $V_{OUT} = V_+/2$ ;  $R_L = 1\ M\Omega$ ;  $T_J = +25^\circ C$ .

Parameters	Symbol	Min.	Typ.	Max.	Units	Conditions
Input Offset Voltage	$V_{OS}$	—	0.11	7	mV	—
		—	0.11	9	mV	$-40^\circ C \leq T_J \leq +85^\circ C$
Input Offset Voltage Average Drift	$TCV_{OS}$	—	1.0	—	$\mu V/^\circ C$	—
Input Bias Current	$I_B$	—	1.0	64	pA	$-40^\circ C \leq T_J \leq +85^\circ C$
Input Offset Current	$I_{OS}$	—	0.5	32	pA	$-40^\circ C \leq T_J \leq +85^\circ C$
Input Resistance	$R_{IN}$	—	>1	—	$T\Omega$	—
Common-Mode Rejection Ratio	CMRR	60	82	—	dB	$0V \leq V_{CM} \leq 5V$ , <a href="#">Note 1</a>
		55	—	—	dB	$0V \leq V_{CM} \leq 5V$ , <a href="#">Note 1</a> , $-40^\circ C \leq T_J \leq +85^\circ C$
Input Common Mode Voltage	$V_{CM}$	—	-0.3	-0.20	V	Input LOW, CMRR $\geq 50$ dB
		—	—	0.00	V	Input LOW, CMRR $\geq 50$ dB, $-40^\circ C \leq T_J \leq +85^\circ C$
		5.20	5.3	—	V	Input HIGH, CMRR $\geq 50$ dB
		5.0	—	—	V	Input HIGH, CMRR $\geq 50$ dB, $-40^\circ C \leq T_J \leq +85^\circ C$
Positive Power Supply Rejection Ratio	+PSRR	65	82	—	dB	$V_+ = 5V$ to 12V, $V_- = 0V$ , $V_{OUT} = 1.5V$
		62	—	—	dB	$V_+ = 5V$ to 12V, $V_- = 0V$ , $V_{OUT} = 1.5V$ , $-40^\circ C \leq T_J \leq +85^\circ C$
Negative Power Supply Rejection Ratio	-PSRR	65	82	—	dB	$V_+ = 0V$ , $V_- = -5V$ to -12V, $V_{OUT} = -1.5V$
		62	—	—	dB	$V_+ = 0V$ , $V_- = -5V$ to -12V, $V_{OUT} = -1.5V$ , $-40^\circ C \leq T_J \leq +85^\circ C$
Common-Mode Input Capacitance	$C_{IN}$	—	3	—	pF	—

**Note 1:** Common-mode performance tends to follow the typical value. Minimum value limits reflect performance only near the supply rails.

**2:** Continuous short circuit may exceed absolute maximum  $T_J$  under some conditions.

# LMC7101

## LM7101B 5.0V DC ELECTRICAL CHARACTERISTICS (CONTINUED)

**Electrical Characteristics:** Unless otherwise indicated,  $V_+ = +5.0V$ ,  $V_- = 0V$ ,  $V_{CM} = 1.5V$ ,  $V_{OUT} = V_+/2$ ;  $R_L = 1\text{ M}\Omega$ ;  $T_J = +25^\circ\text{C}$ .

Parameters	Symbol	Min.	Typ.	Max.	Units	Conditions
Output Swing	$V_{OUT}$	4.9	4.989	—	V	Output HIGH, $R_L = 2\text{ k}\Omega$
		4.85	—	—	V	Output HIGH, $R_L = 2\text{ k}\Omega$ , $-40^\circ\text{C} \leq T_J \leq +85^\circ\text{C}$
		—	0.011	0.1	V	Output LOW, $R_L = 2\text{ k}\Omega$
		—	—	0.15	V	Output LOW, $R_L = 2\text{ k}\Omega$ , $-40^\circ\text{C} \leq T_J \leq +85^\circ\text{C}$
		4.9	4.963	—	V	Output HIGH, $R_L = 600\Omega$
		4.8	—	—	V	Output HIGH, $R_L = 600\Omega$ , $-40^\circ\text{C} \leq T_J \leq +85^\circ\text{C}$
		—	0.037	0.1	V	Output LOW, $R_L = 600\Omega$
		—	—	0.2	V	Output LOW, $R_L = 600\Omega$ , $-40^\circ\text{C} \leq T_J \leq +85^\circ\text{C}$
Output Short Supply Current Note 2	$I_{SC}$	120	200	—	mA	Sourcing ( $V_{OUT} = 0V$ ) or Sinking ( $V_{OUT} = 5V$ )
		80	—	—	mA	Sourcing ( $V_{OUT} = 0V$ ) or Sinking ( $V_{OUT} = 5V$ ), $-40^\circ\text{C} \leq T_J \leq +85^\circ\text{C}$
Supply Current	$I_S$	—	0.5	0.85	mA	—
		—	—	1.0	mA	$-40^\circ\text{C} \leq T_J \leq +85^\circ\text{C}$
<p><b>Note 1:</b> Common-mode performance tends to follow the typical value. Minimum value limits reflect performance only near the supply rails.</p> <p><b>2:</b> Continuous short circuit may exceed absolute maximum <math>T_J</math> under some conditions.</p>						

## LM7101A 12.0V DC ELECTRICAL CHARACTERISTICS

**Electrical Characteristics:** Unless otherwise indicated,  $V_+ = +12V$ ,  $V_- = 0V$ ,  $V_{CM} = 1.5V$ ,  $V_{OUT} = V_+/2$ ;  $R_L = 1\text{ M}\Omega$ ;  $T_J = +25^\circ\text{C}$ .

Parameters	Symbol	Min.	Typ.	Max.	Units	Conditions
Input Offset Voltage	$V_{OS}$	—	0.11	6	mV	—
Input Offset Voltage Average Drift	$TCV_{OS}$	—	1.0	—	$\mu\text{V}/^\circ\text{C}$	—
Input Bias Current	$I_B$	—	1.0	64	pA	$-40^\circ\text{C} \leq T_J \leq +85^\circ\text{C}$
Input Offset Current	$I_{OS}$	—	0.5	32	pA	$-40^\circ\text{C} \leq T_J \leq +85^\circ\text{C}$
Input Resistance	$R_{IN}$	—	>1	—	$\text{T}\Omega$	—
Common-Mode Rejection Ratio	CMRR	65	82	—	dB	$0V \leq V_{CM} \leq 12V$ , <a href="#">Note 1</a>
		60	—	—	dB	$0V \leq V_{CM} \leq 12V$ , <a href="#">Note 1</a> , $-40^\circ\text{C} \leq T_J \leq +85^\circ\text{C}$
Input Common Mode Voltage	$V_{CM}$	—	-0.3	-0.20	V	Input LOW, $V_+ = 12V$ , $\text{CMRR} \geq 50\text{ dB}$
		—	—	0.00	V	Input LOW, $V_+ = 12V$ , $\text{CMRR} \geq 50\text{ dB}$ , $-40^\circ\text{C} \leq T_J \leq +85^\circ\text{C}$
		12.2	12.3	—	V	Input HIGH, $V_+ = 12V$ , $\text{CMRR} \geq 50\text{ dB}$
		12.0	—	—	V	Input HIGH, $V_+ = 12V$ , $\text{CMRR} \geq 50\text{ dB}$ , $-40^\circ\text{C} \leq T_J \leq +85^\circ\text{C}$
Positive Power Supply Rejection Ratio	+PSRR	70	82	—	dB	$V_+ = 5V$ to $12V$ , $V_- = 0V$ , $V_{OUT} = 1.5V$
		65	—	—	dB	$V_+ = 5V$ to $12V$ , $V_- = 0V$ , $V_{OUT} = 1.5V$ , $-40^\circ\text{C} \leq T_J \leq +85^\circ\text{C}$
Negative Power Supply Rejection Ratio	-PSRR	70	82	—	dB	$V_+ = 0V$ , $V_- = -5V$ to $-12V$ , $V_{OUT} = -1.5V$
		65	—	—	dB	$V_+ = 0V$ , $V_- = -5V$ to $-12V$ , $V_{OUT} = -1.5V$ , $-40^\circ\text{C} \leq T_J \leq +85^\circ\text{C}$
Large Signal Voltage Gain	$A_V$	80	340	—	V/mV	Sourcing or sinking, $R_L = 2\text{k}\Omega$ , <a href="#">Note 4</a>
		40	—	—	V/mV	Sourcing or sinking, $R_L = 2\text{k}\Omega$ , <a href="#">Note 4</a> , $-40^\circ\text{C} \leq T_J \leq +85^\circ\text{C}$
		15	300	—	V/mV	Sourcing or sinking, $R_L = 600\Omega$ , <a href="#">Note 4</a>
		10	—	—	V/mV	Sourcing or sinking, $R_L = 600\Omega$ , <a href="#">Note 4</a> , $-40^\circ\text{C} \leq T_J \leq +85^\circ\text{C}$
Common-Mode Input Capacitance	$C_{IN}$	—	3	—	pF	—

**Note 1:** Common-mode performance tends to follow the typical value. Minimum value limits reflect performance only near the supply rails.

**2:** Continuous short circuit may exceed absolute maximum  $T_J$  under some conditions.

**3:** Shorting OUT to  $V_+$  when  $V_+ > 12V$  may damage the device.

**4:**  $R_L$  connected to  $5.0V$ . Sourcing:  $5V \leq V_{OUT} \leq 12V$ . Sinking:  $2.5V \leq V_{OUT} \leq 5V$ .

# LMC7101

## LM7101A 12.0V DC ELECTRICAL CHARACTERISTICS (CONTINUED)

**Electrical Characteristics:** Unless otherwise indicated,  $V_+ = +12V$ ,  $V_- = 0V$ ,  $V_{CM} = 1.5V$ ,  $V_{OUT} = V_+/2$ ;  $R_L = 1\text{ M}\Omega$ ;  $T_J = +25^\circ\text{C}$ .

Parameters	Symbol	Min.	Typ.	Max.	Units	Conditions
Output Swing	$V_{OUT}$	11.9	11.98	—	V	Output HIGH, $V_+ = 12V$ , $R_L = 2\text{ k}\Omega$
		11.87	—	—	V	Output HIGH, $V_+ = 12V$ , $R_L = 2\text{ k}\Omega$ , $-40^\circ\text{C} \leq T_J \leq +85^\circ\text{C}$
		—	0.02	0.10	V	Output LOW, $V_+ = 12V$ , $R_L = 2\text{ k}\Omega$
		—	—	0.13	V	Output LOW, $V_+ = 12V$ , $R_L = 2\text{ k}\Omega$ , $-40^\circ\text{C} \leq T_J \leq +85^\circ\text{C}$
		11.73	11.93	—	V	Output HIGH, $V_+ = 12V$ , $R_L = 600\Omega$
		11.65	—	—	V	Output HIGH, $V_+ = 12V$ , $R_L = 600\Omega$ , $-40^\circ\text{C} \leq T_J \leq +85^\circ\text{C}$
		—	0.07	0.27	V	Output LOW, $V_+ = 12V$ , $R_L = 600\Omega$
		—	—	0.35	V	Output LOW, $V_+ = 12V$ , $R_L = 600\Omega$ , $-40^\circ\text{C} \leq T_J \leq +85^\circ\text{C}$
Output Short Supply Current Note 2	$I_{SC}$	200	300	—	mA	Sourcing ( $V_{OUT} = 0V$ ) or Sinking ( $V_{OUT} = 12V$ ), Note 2, 3
		120	—	—	mA	Sourcing ( $V_{OUT} = 0V$ ) or Sinking ( $V_{OUT} = 12V$ ), Note 2, 3, $-40^\circ\text{C} \leq T_J \leq +85^\circ\text{C}$
Supply Current	$I_S$	—	0.8	1.5	mA	—
		—	—	1.71	mA	$-40^\circ\text{C} \leq T_J \leq +85^\circ\text{C}$
<p><b>Note 1:</b> Common-mode performance tends to follow the typical value. Minimum value limits reflect performance only near the supply rails.</p> <p><b>2:</b> Continuous short circuit may exceed absolute maximum <math>T_J</math> under some conditions.</p> <p><b>3:</b> Shorting OUT to <math>V_+</math> when <math>V_+ &gt; 12V</math> may damage the device.</p> <p><b>4:</b> <math>R_L</math> connected to 5.0V. Sourcing: <math>5V \leq V_{OUT} \leq 12V</math>. Sinking: <math>2.5V \leq V_{OUT} \leq 5V</math>.</p>						

## LM7101B 12.0V DC ELECTRICAL CHARACTERISTICS

**Electrical Characteristics:** Unless otherwise indicated,  $V_+ = +12V$ ,  $V_- = 0V$ ,  $V_{CM} = 1.5V$ ,  $V_{OUT} = V_+/2$ ;  $R_L = 1\text{ M}\Omega$ ;  $T_J = +25^\circ\text{C}$ .

Parameters	Symbol	Min.	Typ.	Max.	Units	Conditions
Input Offset Voltage	$V_{OS}$	—	0.11	9	mV	—
Input Offset Voltage Average Drift	$TCV_{OS}$	—	1.0	—	$\mu\text{V}/^\circ\text{C}$	—
Input Bias Current	$I_B$	—	1.0	64	pA	$-40^\circ\text{C} \leq T_J \leq +85^\circ\text{C}$
Input Offset Current	$I_{OS}$	—	0.5	32	pA	$-40^\circ\text{C} \leq T_J \leq +85^\circ\text{C}$
Input Resistance	$R_{IN}$	—	>1	—	$\text{T}\Omega$	—
Common-Mode Rejection Ratio	CMRR	65	82	—	dB	$0V \leq V_{CM} \leq 12V$ , <a href="#">Note 1</a>
		60	—	—	dB	$0V \leq V_{CM} \leq 12V$ , <a href="#">Note 1</a> , $-40^\circ\text{C} \leq T_J \leq +85^\circ\text{C}$
Input Common Mode Voltage	$V_{CM}$	—	-0.3	-0.20	V	Input LOW, $V_+ = 12V$ , CMRR $\geq 50\text{ dB}$
		—	—	0.00	V	Input LOW, $V_+ = 12V$ , CMRR $\geq 50\text{ dB}$ , $-40^\circ\text{C} \leq T_J \leq +85^\circ\text{C}$
		12.2	12.3	—	V	Input HIGH, $V_+ = 12V$ , CMRR $\geq 50\text{ dB}$
		12.0	—	—	V	Input HIGH, $V_+ = 12V$ , CMRR $\geq 50\text{ dB}$ , $-40^\circ\text{C} \leq T_J \leq +85^\circ\text{C}$
Positive Power Supply Rejection Ratio	+PSRR	65	82	—	dB	$V_+ = 5V$ to $12V$ , $V_- = 0V$ , $V_{OUT} = 1.5V$
		62	—	—	db	$V_+ = 5V$ to $12V$ , $V_- = 0V$ , $V_{OUT} = 1.5V$ , $-40^\circ\text{C} \leq T_J \leq +85^\circ\text{C}$
Negative Power Supply Rejection Ratio	-PSRR	65	82	—	dB	$V_+ = 0V$ , $V_- = -5V$ to $-12V$ , $V_{OUT} = -1.5V$
		62	—	—	dB	$V_+ = 0V$ , $V_- = -5V$ to $-12V$ , $V_{OUT} = -1.5V$ , $-40^\circ\text{C} \leq T_J \leq +85^\circ\text{C}$
Large Signal Voltage Gain	$A_V$	80	340	—	V/mV	Sourcing or sinking, $R_L = 2\text{k}\Omega$ , <a href="#">Note 4</a>
		40	—	—	V/mV	Sourcing or sinking, $R_L = 2\text{k}\Omega$ , <a href="#">Note 4</a> , $-40^\circ\text{C} \leq T_J \leq +85^\circ\text{C}$
		15	300	—	V/mV	Sourcing or sinking, $R_L = 600\Omega$ , <a href="#">Note 4</a>
		10	—	—	V/mV	Sourcing or sinking, $R_L = 600\Omega$ , <a href="#">Note 4</a> , $-40^\circ\text{C} \leq T_J \leq +85^\circ\text{C}$
Common-Mode Input Capacitance	$C_{IN}$	—	3	—	pF	—

**Note 1:** Common-mode performance tends to follow the typical value. Minimum value limits reflect performance only near the supply rails.

**2:** Continuous short circuit may exceed absolute maximum  $T_J$  under some conditions.

**3:** Shorting OUT to  $V_+$  when  $V_+ > 12V$  may damage the device.

**4:**  $R_L$  connected to  $5.0V$ . Sourcing:  $5V \leq V_{OUT} \leq 12V$ . Sinking:  $2.5V \leq V_{OUT} \leq 5V$ .

# LMC7101

## LM7101B 12.0V DC ELECTRICAL CHARACTERISTICS (CONTINUED)

**Electrical Characteristics:** Unless otherwise indicated,  $V_+ = +12V$ ,  $V_- = 0V$ ,  $V_{CM} = 1.5V$ ,  $V_{OUT} = V_+/2$ ;  $R_L = 1\text{ M}\Omega$ ;  $T_J = +25^\circ\text{C}$ .

Parameters	Symbol	Min.	Typ.	Max.	Units	Conditions
Output Swing	$V_{OUT}$	11.9	11.98	—	V	Output HIGH, $V_+ = 12V$ , $R_L = 2\text{ k}\Omega$
		11.87	—	—	V	Output HIGH, $V_+ = 12V$ , $R_L = 2\text{ k}\Omega$ , $-40^\circ\text{C} \leq T_J \leq +85^\circ\text{C}$
		—	0.02	0.10	V	Output LOW, $V_+ = 12V$ , $R_L = 2\text{ k}\Omega$
		—	—	0.13	V	Output LOW, $V_+ = 12V$ , $R_L = 2\text{ k}\Omega$ , $-40^\circ\text{C} \leq T_J \leq +85^\circ\text{C}$
		11.73	11.93	—	V	Output HIGH, $V_+ = 12V$ , $R_L = 600\Omega$
		11.65	—	—	V	Output HIGH, $V_+ = 12V$ , $R_L = 600\Omega$ , $-40^\circ\text{C} \leq T_J \leq +85^\circ\text{C}$
		—	0.07	0.27	V	Output LOW, $V_+ = 12V$ , $R_L = 600\Omega$
		—	—	0.35	V	Output LOW, $V_+ = 12V$ , $R_L = 600\Omega$ , $-40^\circ\text{C} \leq T_J \leq +85^\circ\text{C}$
Output Short Supply Current Note 2	$I_{SC}$	200	300	—	mA	Sourcing ( $V_{OUT} = 0V$ ) or Sinking ( $V_{OUT} = 12V$ ), Note 2, 3
		120	—	—	mA	Sourcing ( $V_{OUT} = 0V$ ) or Sinking ( $V_{OUT} = 12V$ ), Note 2, 3, $-40^\circ\text{C} \leq T_J \leq +85^\circ\text{C}$
Supply Current	$I_S$	—	0.8	1.5	mA	—
		—	—	1.71	mA	$-40^\circ\text{C} \leq T_J \leq +85^\circ\text{C}$

**Note 1:** Common-mode performance tends to follow the typical value. Minimum value limits reflect performance only near the supply rails.

**2:** Continuous short circuit may exceed absolute maximum  $T_J$  under some conditions.

**3:** Shorting OUT to  $V_+$  when  $V_+ > 12V$  may damage the device.

**4:**  $R_L$  connected to 5.0V. Sourcing:  $5V \leq V_{OUT} \leq 12V$ . Sinking:  $2.5V \leq V_{OUT} \leq 5V$ .

## LM7101A 5.0V AC ELECTRICAL CHARACTERISTICS

**Electrical Characteristics:** Unless otherwise indicated,  $V_+ = +5V$ ,  $V_- = 0V$ ,  $V_{CM} = 1.5V$ ,  $V_{OUT} = V_+/2$ ;  $R_L = 1\text{ M}\Omega$ ;  $T_J = +25^\circ\text{C}$ .

Parameters	Symbol	Min.	Typ.	Max.	Units	Conditions
Total Harmonic Distortion	THD	—	0.01	—	%	$f = 10\text{ kHz}$ , $A_V = -2$ , $R_L = 2\text{ k}\Omega$ , $V_{OUT} = 4.0\text{ V}_{PP}$
Slew Rate	SR	—	0.3	—	V/ $\mu\text{s}$	—
Gain Bandwidth Product	GBW	—	0.5	—	MHz	—

## LM7101B 5.0V AC ELECTRICAL CHARACTERISTICS

**Electrical Characteristics:** Unless otherwise indicated,  $V_+ = +5V$ ,  $V_- = 0V$ ,  $V_{CM} = 1.5V$ ,  $V_{OUT} = V_+/2$ ;  $R_L = 1\text{ M}\Omega$ ;  $T_J = +25^\circ\text{C}$ .

Parameters	Symbol	Min.	Typ.	Max.	Units	Conditions
Total Harmonic Distortion	THD	—	0.01	—	%	$f = 10\text{ kHz}$ , $A_V = -2$ , $R_L = 2\text{ k}\Omega$ , $V_{OUT} = 4.0\text{ V}_{PP}$
Slew Rate	SR	—	0.3	—	$\text{V}/\mu\text{s}$	—
Gain Bandwidth Product	GBW	—	0.5	—	MHz	—

## LM7101A 12.0V AC ELECTRICAL CHARACTERISTICS

**Electrical Characteristics:** Unless otherwise indicated,  $V_+ = +12V$ ,  $V_- = 0V$ ,  $V_{CM} = 1.5V$ ,  $V_{OUT} = V_+/2$ ;  $R_L = 1\text{ M}\Omega$ ;  $T_J = +25^\circ\text{C}$ .

Parameters	Symbol	Min.	Typ.	Max.	Units	Conditions
Total Harmonic Distortion	THD	—	0.01	—	%	$f = 10\text{ kHz}$ , $A_V = -2$ , $R_L = 2\text{ k}\Omega$ , $V_{OUT} = 8.5\text{ V}_{PP}$
Slew Rate	SR	0.19	0.3	—	$\text{V}/\mu\text{s}$	$V_+ = 12V$ , <a href="#">Note 1</a>
		0.15	—	—	$\text{V}/\mu\text{s}$	$V_+ = 12V$ , <a href="#">Note 1</a> , $-40^\circ\text{C} \leq T_J \leq +85^\circ\text{C}$
Gain-Bandwidth Product	GBW	—	0.5	—	MHz	—
Phase Margin	$\Phi_m$	—	45	—	$^\circ$	—
Gain Margin	$G_m$	—	10	—	dB	—
Input-Referred Voltage Noise	$e_n$	—	37	—	$nV/\sqrt{\text{Hz}}$	$f = 1\text{ kHz}$ , $V_{CM} = 1V$
Input-Referred Current Noise	$i_n$	—	1.5	—	$fA/\sqrt{\text{Hz}}$	$f = 1\text{ kHz}$

**Note 1:** Device connected as a voltage follower with a 12V step input. The value is the positive or negative slew rate, whichever is slower.

# LMC7101

## LM7101B 12.0V AC ELECTRICAL CHARACTERISTICS

**Electrical Characteristics:** Unless otherwise indicated,  $V_+ = +12V$ ,  $V_- = 0V$ ,  $V_{CM} = 1.5V$ ,  $V_{OUT} = V_+/2$ ;  $R_L = 1M\Omega$ ;  $T_J = +25^\circ C$ .

Parameters	Symbol	Min.	Typ.	Max.	Units	Conditions
Total Harmonic Distortion	THD	—	0.01	—	%	$f = 10\text{ kHz}$ , $A_V = -2$ , $R_L = 2\text{ k}\Omega$ , $V_{OUT} = 8.5\text{ V}_{PP}$
Slew Rate	SR	0.19	0.3	—	$V/\mu s$	$V_+ = 12V$ , <a href="#">Note 1</a>
		0.15	—	—	$V/\mu s$	$V_+ = 12V$ , <a href="#">Note 1</a> , $-40^\circ C \leq T_J \leq +85^\circ C$
Gain-Bandwidth Product	GBW	—	0.5	—	MHz	—
Phase Margin	$\Phi_m$	—	45	—	$^\circ$	—
Gain Margin	$G_m$	—	10	—	dB	—
Input-Referred Voltage Noise	$e_n$	—	37	—	$nV/\sqrt{Hz}$	$f = 1\text{ kHz}$ , $V_{CM} = 1V$
Input-Referred Current Noise	$i_n$	—	1.5	—	$fA/\sqrt{Hz}$	$f = 1\text{ kHz}$

**Note 1:** Device connected as a voltage follower with a 12V step input. The value is the positive or negative slew rate, whichever is slower.

## TEMPERATURE SPECIFICATIONS ([Note 1](#))

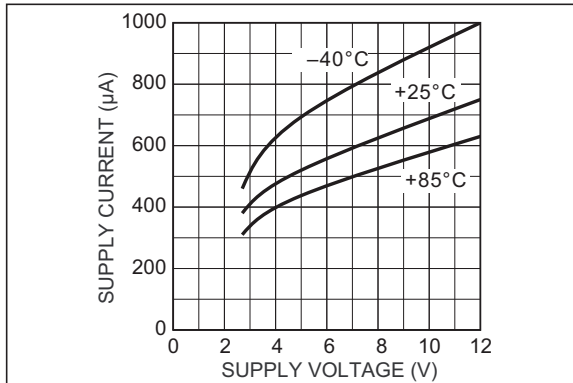
Parameters	Sym.	Min.	Typ.	Max.	Units	Conditions
<b>Temperature Ranges</b>						
Operating Ambient Temperature Range	$T_A$	-40	—	+85	$^\circ C$	—
Junction Operating Temperature	$T_J$	-40	—	+125	$^\circ C$	—
Max. Junction Operating Temperature	$T_{J(max)}$	—	—	+125	$^\circ C$	—
Storage Temperature Range	$T_A$	-65	—	+150	$^\circ C$	—
<b>Package Thermal Resistances</b>						
Thermal Resistance	$\theta_{JA}$	—	325	—	$^\circ C/W$	—

**Note 1:** Absolute maximum ratings indicate limits beyond which damage to the component may occur. Electrical specifications do not apply when operating the device outside its recommended operating ratings.

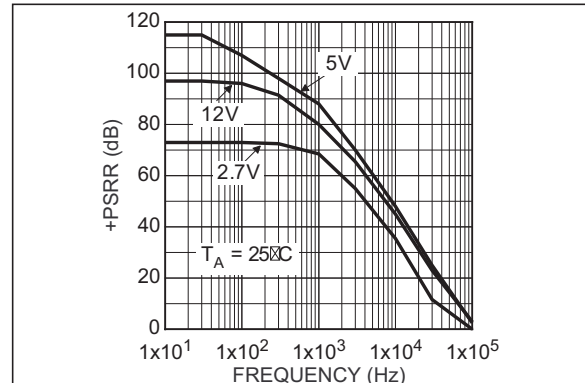


## 2.0 TYPICAL PERFORMANCE CURVES

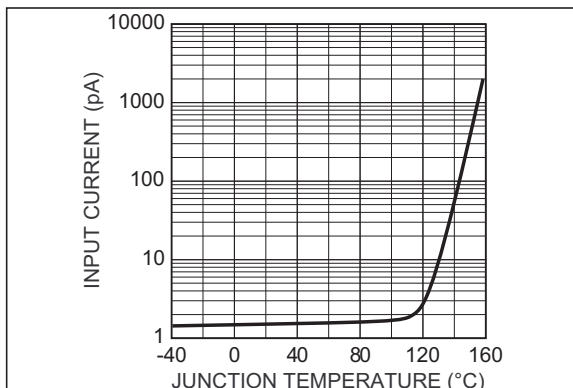
**Note:** The graphs and tables provided following this note are a statistical summary based on a limited number of samples and are provided for informational purposes only. The performance characteristics listed herein are not tested or guaranteed. In some graphs or tables, the data presented may be outside the specified operating range (e.g., outside specified power supply range) and therefore outside the warranted range.



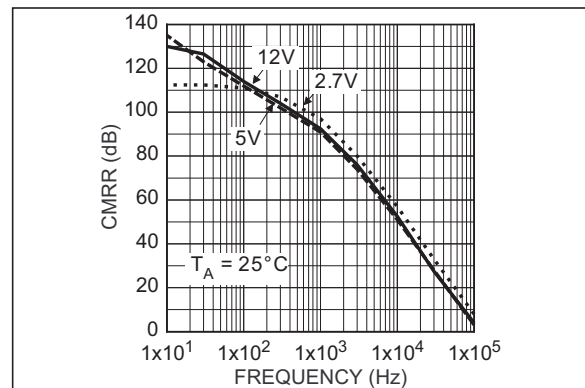
**FIGURE 2-1:** Supply Current vs. Supply Voltage.



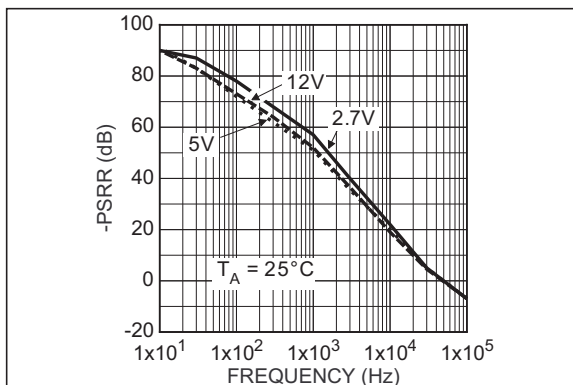
**FIGURE 2-4:** +PSRR vs. Frequency.



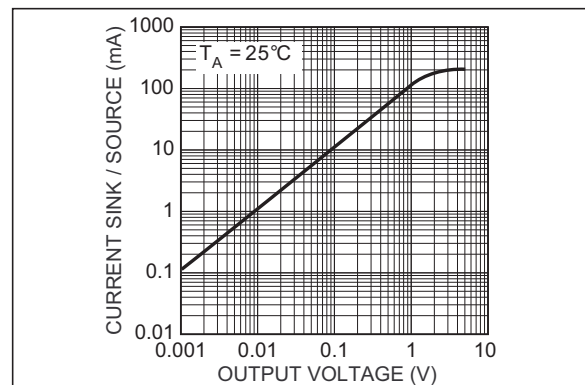
**FIGURE 2-2:** Input Current vs. Junction Temperature.



**FIGURE 2-5:** CMRR vs. Frequency.

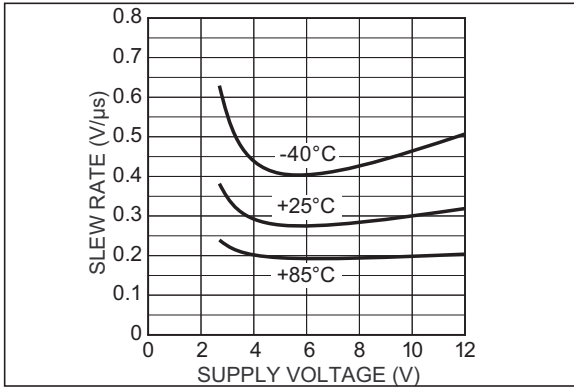


**FIGURE 2-3:** -PSRR vs. Frequency.

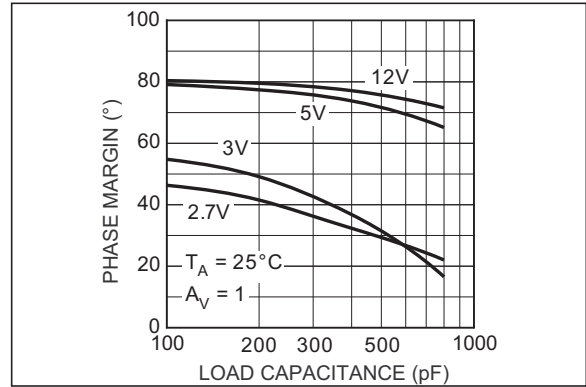


**FIGURE 2-6:** Sink/Source Current vs. Output Voltage.

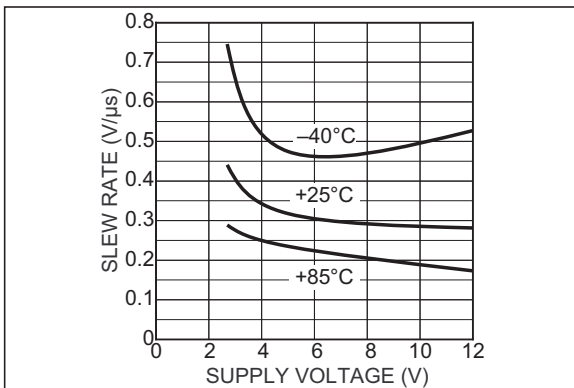
# LMC7101



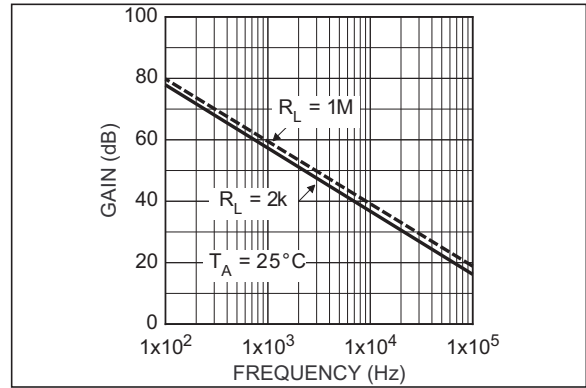
**FIGURE 2-7:** Falling Slew Rate vs. Supply Voltage.



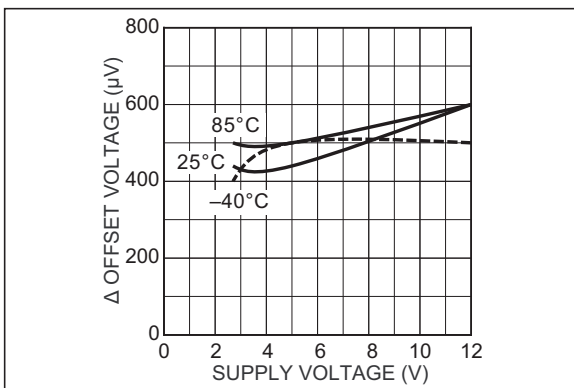
**FIGURE 2-10:** Phase Margin vs. Capacitance Load.



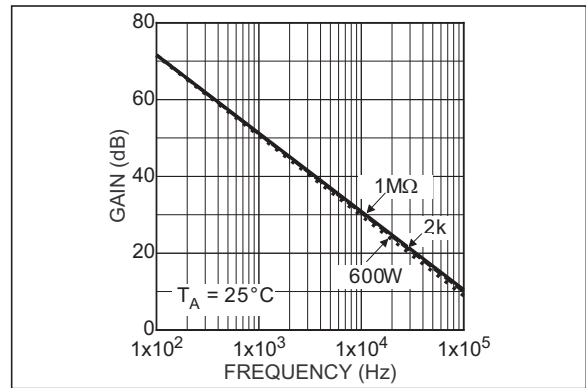
**FIGURE 2-8:** Rising Slew Rate vs. Supply Voltage.



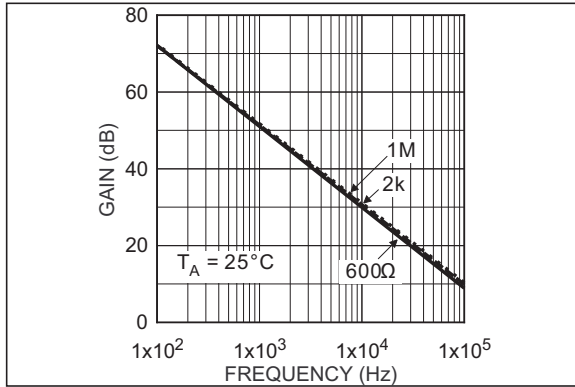
**FIGURE 2-11:** 2.7V Open-Loop Frequency Response.



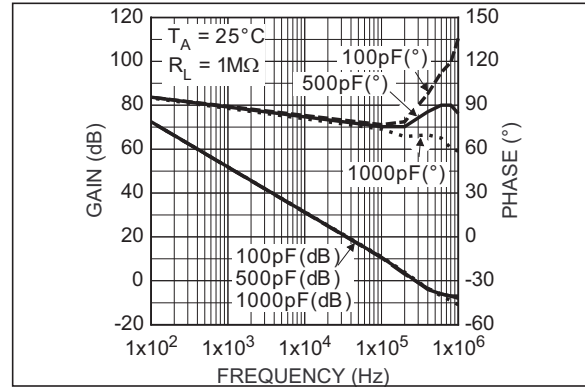
**FIGURE 2-9:** Offset Voltage vs. Supply Voltage.



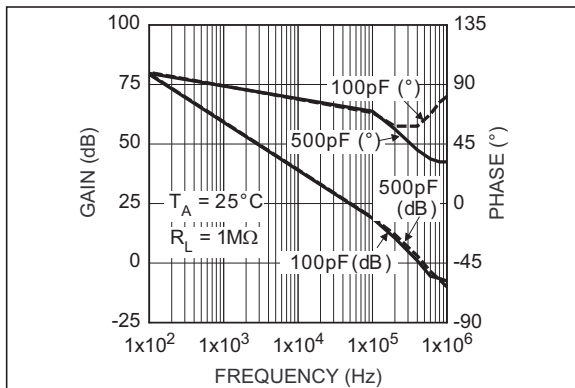
**FIGURE 2-12:** 5V Open-Loop Frequency Response.



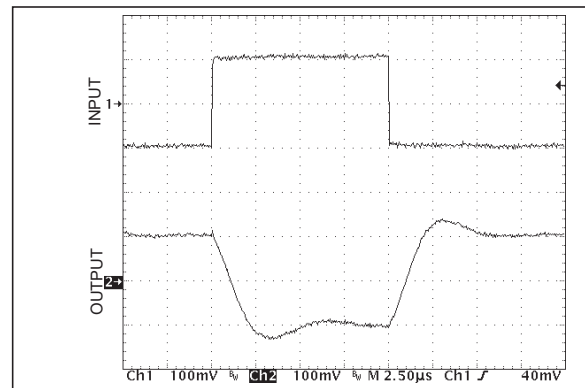
**FIGURE 2-13:** 12V Open-Loop Frequency Response.



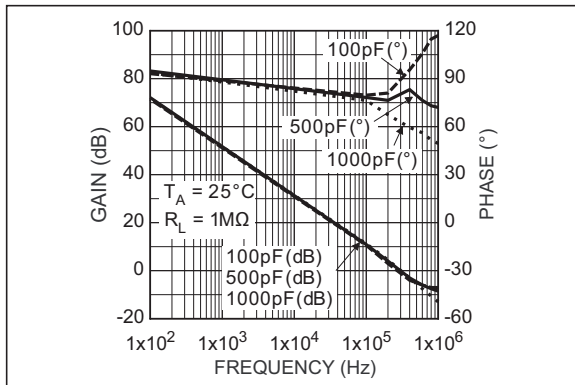
**FIGURE 2-16:** 12V Open-Loop Gain and Phase.



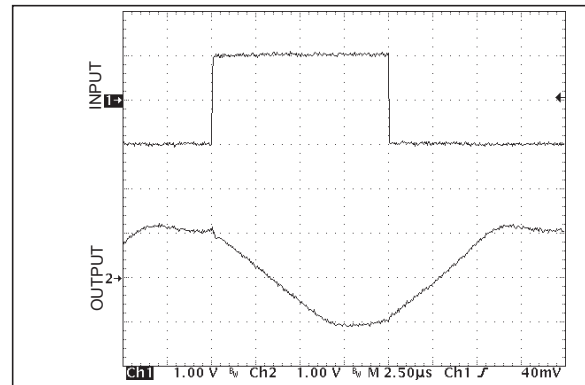
**FIGURE 2-14:** 2.7V Open-Loop Gain and Phase.



**FIGURE 2-17:** Inverting Small-Signal Pulse Response.

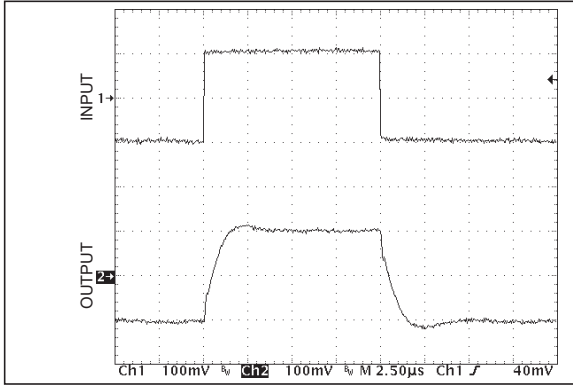


**FIGURE 2-15:** 5V Open-Loop Gain and Phase.

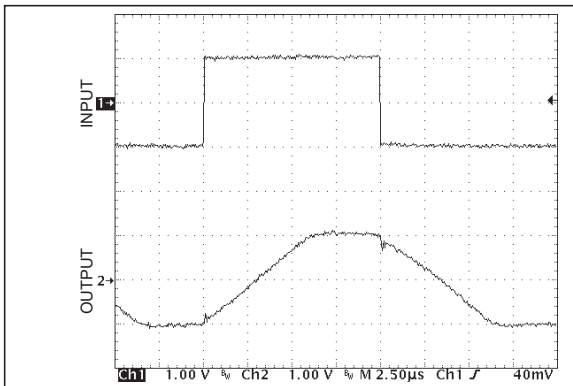


**FIGURE 2-18:** Inverting Large-Signal Pulse Response.

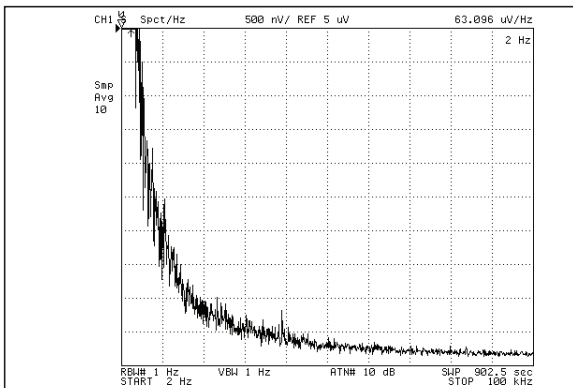
# LMC7101



**FIGURE 2-19:** Non-Inverting Small-Signal Pulse Response.



**FIGURE 2-20:** Non-Inverting Large-Signal Pulse Response.



**FIGURE 2-21:** Input Voltage Noise vs. Frequency.

## 3.0 PIN DESCRIPTIONS

The descriptions of the pins are listed in [Table 3-1](#).

**TABLE 3-1: PIN FUNCTION TABLE**

Pin Number	Symbol	Description
1	OUT	Amplifier Output
2	V+	Positive Supply
3	IN+	Non-Inverting Input
4	IN-	Inverting Input
5	V-	Negative Supply: Negative supply for split-supply application or ground for single-supply application.

# LMC7101

## 4.0 APPLICATION INFORMATION

### 4.1 Input Common-Mode Voltage

Some amplifiers exhibit undesirable or unpredictable performance when the inputs are driven beyond the common-mode voltage range; for example, phase inversion of the output signal. The LMC7101 tolerates input overdrive by at least 200 mV beyond either rail without producing phase inversion.

If the absolute maximum input voltage (700 mV beyond either rail) is exceeded, the input current should be limited to  $\pm 5$  mA maximum to prevent reducing reliability. A 10 k $\Omega$  series input resistor, used as a current limiter, will protect the input structure from voltages as large as 50V above the supply or below ground. See Figure 4-1.

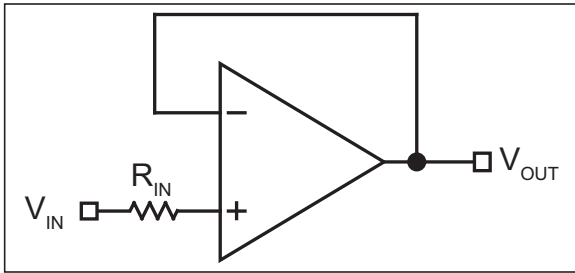


FIGURE 4-1: Input Current-Limit Protection.

### 4.2 Output Voltage Swing

Sink and source output resistances of the LMC7101 are equal. Maximum output voltage swing is determined by the load and the approximate output resistance. To calculate the output resistance, use Equation 4-1:

#### EQUATION 4-1:

$$R_{OUT} = \frac{V_{DROP}}{I_{LOAD}}$$

$V_{DROP}$  is the voltage dropped within the amplifier output stage.  $V_{DROP}$  and  $I_{LOAD}$  can be determined from the  $V_O$  (output swing) portion of the appropriate [Electrical Characteristics](#) table.  $I_{LOAD}$  is equal to the typical output high voltage minus  $V+/2$  and divided by  $R_{LOAD}$ . For example, using the [LM7101A 5.0V DC Electrical Characteristics](#) table, the typical output high voltage using a 2 k $\Omega$  load (connected to  $V+/2$ ) is 4.989V, which produces an  $I_{LOAD}$  of:

#### EQUATION 4-2:

$$1.245mA \times \left( \frac{4.989V - 2.5V}{2k\Omega} \right) = 1.245mA$$

Voltage drop in the amplifier output stage is:

$$V_{DROP} = 5.0V - 4.989V$$

$$V_{DROP} = 0.011V$$

Because of output stage symmetry, the corresponding typical output low voltage (0.011V) also equals  $V_{DROP}$ .

#### EQUATION 4-3:

$$R_{OUT} = \frac{0.011V}{0.001245A} = 8.8 \approx 9\Omega$$

### 4.3 Driving Capacitive Loads

Driving a capacitive load introduces phase-lag into the output signal, and this in turn reduces op-amp system phase margin. The application that is least forgiving of reduced phase margin is a unity gain amplifier. The LMC7101 can typically drive a 100 pF capacitive load connected directly to the output when configured as a unity-gain amplifier.

### 4.4 Using Large-Value Feedback Resistors

A large-value feedback resistor (> 500 k $\Omega$ ) can reduce the phase margin of a system. This occurs when the feedback resistor acts in conjunction with input capacitance to create phase lag in the feedback signal. Input capacitance is usually a combination of input circuit components and other parasitic capacitance, such as amplifier input capacitance and stray printed circuit board capacitance.

Figure 4-2 illustrates a method of compensating phase lag caused by using a large-value feedback resistor. Feedback capacitor  $C_{FB}$  introduces sufficient phase lead to overcome the phase lag caused by feedback resistor  $R_{FB}$  and input capacitance  $C_{IN}$ . The value of  $C_{FB}$  is determined by first estimating  $C_{IN}$  and then applying the following formula from Equation 4-4:

#### EQUATION 4-4:

$$R_{IN} \times C_{IN} \leq R_{FB} \times C_{FB}$$

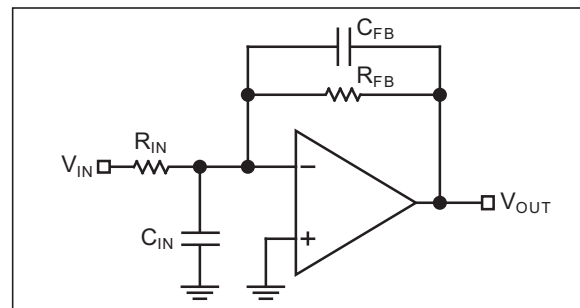
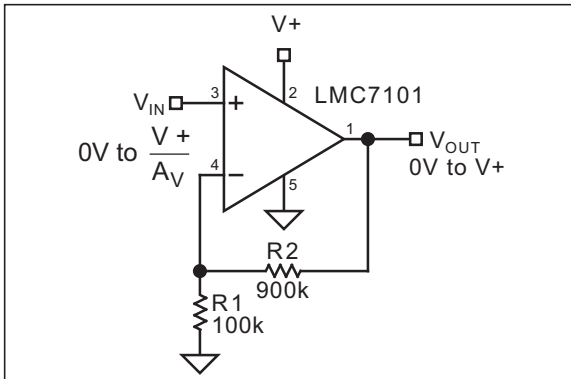


FIGURE 4-2: Canceling Feedback Phase Lag.

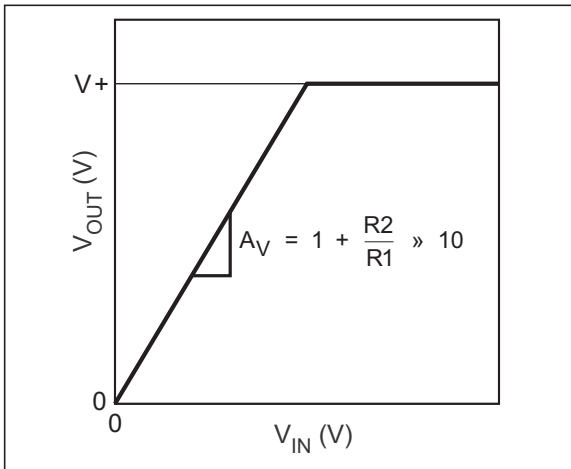
Since a significant percentage of  $C_{IN}$  may be caused by board layout, it is important to note that the correct value of  $C_{FB}$  may change when changing from a breadboard to the final circuit layout.

## 4.5 Typical Circuits

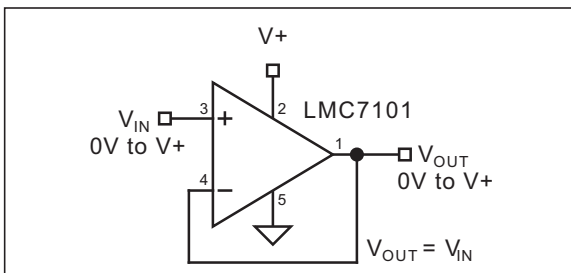
Some suitable LMC7101 single-supply, rail-to-rail applications are shown in the following circuit diagrams.



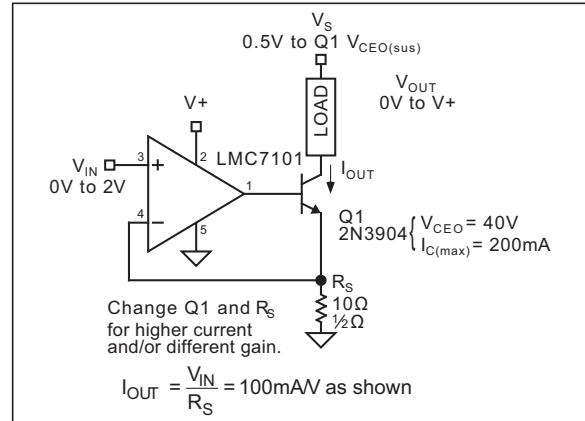
**FIGURE 4-3:** Non-Inverting Amplifier.



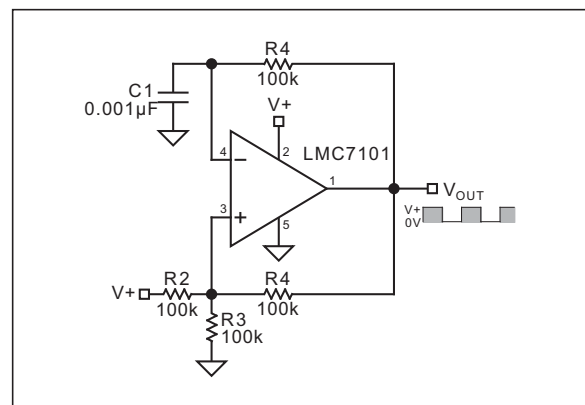
**FIGURE 4-4:** Non-Inverting Amplifier Behavior.



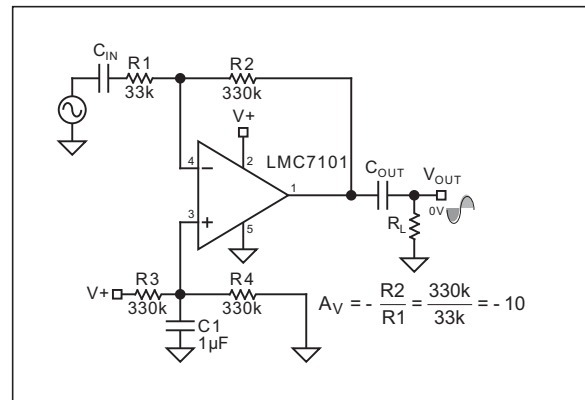
**FIGURE 4-5:** Voltage Follower.



**FIGURE 4-6:** Voltage-Controlled Current Sink.



**FIGURE 4-7:** Square Wave Oscillator.



**FIGURE 4-8:** AC-Coupled Inverting Amplifier.

# LMC7101

## 5.0 PACKAGING INFORMATION

### 5.1 Package Marking Information

5-Lead SOT-23\*

Example

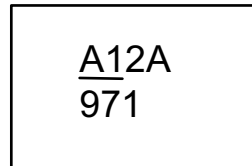
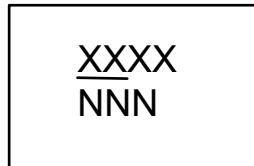


TABLE 5-1: MARKING CODES

Device	Marking Code
LMC7101A	A12A
LMC7101B	A12

<p><b>Legend:</b> XX...X Product code or customer-specific information Y Year code (last digit of calendar year) YY Year code (last 2 digits of calendar year) WW Week code (week of January 1 is week '01') NNN Alphanumeric traceability code (e3) Pb-free JEDEC® designator for Matte Tin (Sn) * This package is Pb-free. The Pb-free JEDEC designator ((e3)) can be found on the outer packaging for this package.  •, ▲, ▼ Pin one index is identified by a dot, delta up, or delta down (triangle mark).</p>
<p><b>Note:</b> In the event the full Microchip part number cannot be marked on one line, it will be carried over to the next line, thus limiting the number of available characters for customer-specific information. Package may or may not include the corporate logo.  Underbar ( _ ) and/or Overbar ( ¯ ) symbol may not be to scale.</p>

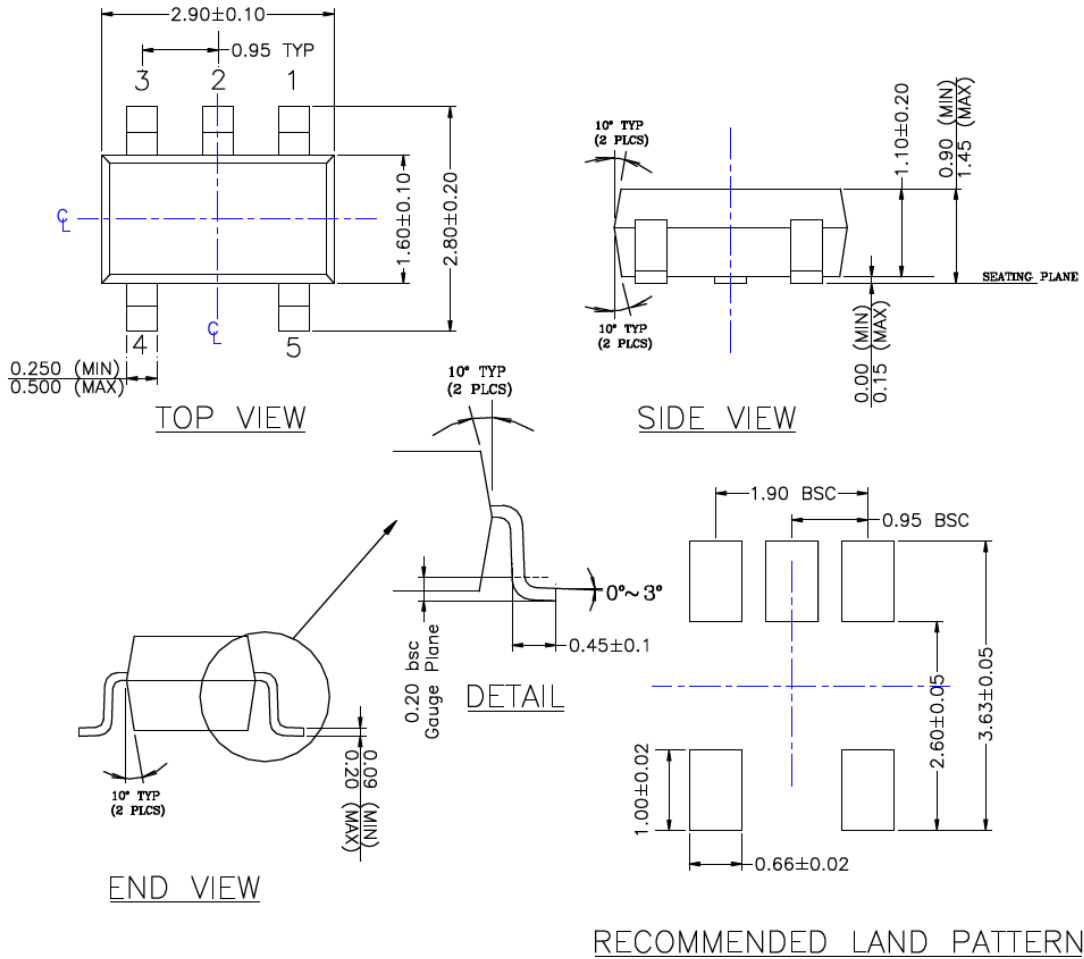


## 5-Lead SOT-23 Package Outline and Recommended Land Pattern

**TITLE**

5 LEAD SOT23 PACKAGE OUTLINE & RECOMMENDED LAND PATTERN

<b>DRAWING #</b>	SOT23-5LD-PL-1	<b>UNIT</b>	MM
------------------	----------------	-------------	----



**NOTE:**

1. PACKAGE OUTLINE EXCLUSIVE OF MOLD FLASH & BURR.
2. PACKAGE OUTLINE INCLUSIVE OF SOLER PLATING.
3. DIMENSION AND TOLERANCE PER ANSI Y14.5M, 1982.
4. FOOT LENGTH MEASUREMENT BASED ON GAUGE PLANE METHOD.
5. DIE FACES UP FOR MOLD, AND FACES DOWN FOR TRIM/FORM.
6. ALL DIMENSIONS ARE IN MILLIMETERS.

Note: For the most current package drawings, please see the Microchip Packaging Specification located at <http://www.microchip.com/packaging>.

# LMC7101

---

NOTES:

## APPENDIX A: REVISION HISTORY

### Revision A (December 2019)

- Converted Micrel document LMC7101 to Microchip data sheet template DS20006282A.
- Minor grammatical text changes throughout.

# MCP1711

---

NOTES:

## PRODUCT IDENTIFICATION SYSTEM

To order or obtain information, e.g., on pricing or delivery, contact your local Microchip representative or sales office.

<u>PART NO.</u>		<u>X</u>	<u>XX</u>	<u>-XX</u>
Device		Temperature Range	Package	Media Type
<b>Device:</b>	LMC7101A: Low-Power Operational Amplifier, A Grade LMC7101B: Low-Power Operational Amplifier, B Grade			
<b>Temperature Range:</b>	Y = -40°C to +85°C			
<b>Packages:</b>	M5 = 5-Lead SOT-23			
<b>Media Type:</b>	TR = 3,000/Reel			

**Examples:**

a) LMC7101AYM5-TR: Low-Power Operational Amplifier, A Grade, -40°C to +85°C Temperature Range, 5-Lead SOT-23, 3,000/Reel

b) LMC7101BYM5-TR: Low-Power Operational Amplifier, B Grade, -40°C to +85°C Temperature Range, 5-Lead SOT-23, 3,000/Reel

**Note 1:** Tape and Reel identifier only appears in the catalog part number description. This identifier is used for ordering purposes and is not printed on the device package. Check with your Microchip Sales Office for package availability with the Tape and Reel option.

# LMC7101

---

NOTES:

---

---

**Note the following details of the code protection feature on Microchip devices:**

- Microchip products meet the specification contained in their particular Microchip Data Sheet.
- Microchip believes that its family of products is one of the most secure families of its kind on the market today, when used in the intended manner and under normal conditions.
- There are dishonest and possibly illegal methods used to breach the code protection feature. All of these methods, to our knowledge, require using the Microchip products in a manner outside the operating specifications contained in Microchip's Data Sheets. Most likely, the person doing so is engaged in theft of intellectual property.
- Microchip is willing to work with the customer who is concerned about the integrity of their code.
- Neither Microchip nor any other semiconductor manufacturer can guarantee the security of their code. Code protection does not mean that we are guaranteeing the product as “unbreakable.”

Code protection is constantly evolving. We at Microchip are committed to continuously improving the code protection features of our products. Attempts to break Microchip's code protection feature may be a violation of the Digital Millennium Copyright Act. If such acts allow unauthorized access to your software or other copyrighted work, you may have a right to sue for relief under that Act.

---

Information contained in this publication regarding device applications and the like is provided only for your convenience and may be superseded by updates. It is your responsibility to ensure that your application meets with your specifications. MICROCHIP MAKES NO REPRESENTATIONS OR WARRANTIES OF ANY KIND WHETHER EXPRESS OR IMPLIED, WRITTEN OR ORAL, STATUTORY OR OTHERWISE, RELATED TO THE INFORMATION, INCLUDING BUT NOT LIMITED TO ITS CONDITION, QUALITY, PERFORMANCE, MERCHANTABILITY OR FITNESS FOR PURPOSE. Microchip disclaims all liability arising from this information and its use. Use of Microchip devices in life support and/or safety applications is entirely at the buyer's risk, and the buyer agrees to defend, indemnify and hold harmless Microchip from any and all damages, claims, suits, or expenses resulting from such use. No licenses are conveyed, implicitly or otherwise, under any Microchip intellectual property rights unless otherwise stated.

### Trademarks

The Microchip name and logo, the Microchip logo, Adaptec, AnyRate, AVR, AVR logo, AVR Freaks, BesTime, BitCloud, chipKIT, chipKIT logo, CryptoMemory, CryptoRF, dsPIC, FlashFlex, flexPWR, HELDO, IGLOO, JukeBlox, KeeLoq, Klear, LANCheck, LinkMD, maXStylus, maXTouch, MediaLB, megaAVR, Microsemi, Microsemi logo, MOST, MOST logo, MPLAB, OptoLyzer, PackeTime, PIC, picoPower, PICSTART, PIC32 logo, PolarFire, Prochip Designer, QTouch, SAM-BA, SenGenuity, SpyNIC, SST, SST Logo, SuperFlash, Symmetricom, SyncServer, Tachyon, TempTrackr, TimeSource, tinyAVR, UNI/O, Vectron, and XMEGA are registered trademarks of Microchip Technology Incorporated in the U.S.A. and other countries.

APT, ClockWorks, The Embedded Control Solutions Company, EtherSynch, FlashTec, Hyper Speed Control, HyperLight Load, IntelliMOS, Libero, motorBench, mTouch, Powermite 3, Precision Edge, ProASIC, ProASIC Plus, ProASIC Plus logo, Quiet-Wire, SmartFusion, SyncWorld, Temux, TimeCesium, TimeHub, TimePictra, TimeProvider, Vite, WinPath, and ZL are registered trademarks of Microchip Technology Incorporated in the U.S.A.

Adjacent Key Suppression, AKS, Analog-for-the-Digital Age, Any Capacitor, AnyIn, AnyOut, BlueSky, BodyCom, CodeGuard, CryptoAuthentication, CryptoAutomotive, CryptoCompanion, CryptoController, dsPICDEM, dsPICDEM.net, Dynamic Average Matching, DAM, ECAN, EtherGREEN, In-Circuit Serial Programming, ICSP, INICnet, Inter-Chip Connectivity, JitterBlocker, KlearNet, KlearNet logo, memBrain, Mindi, MiWi, MPASM, MPF, MPLAB Certified logo, MPLIB, MPLINK, MultiTRAK, NetDetach, Omniscient Code Generation, PICDEM, PICDEM.net, PICKit, PICtail, PowerSmart, PureSilicon, QMatrix, REAL ICE, Ripple Blocker, SAM-ICE, Serial Quad I/O, SMART-I.S., SQI, SuperSwitcher, SuperSwitcher II, Total Endurance, TSHARC, USBCheck, VariSense, ViewSpan, WiperLock, Wireless DNA, and ZENA are trademarks of Microchip Technology Incorporated in the U.S.A. and other countries.

SQTP is a service mark of Microchip Technology Incorporated in the U.S.A.

The Adaptec logo, Frequency on Demand, Silicon Storage Technology, and Symmcom are registered trademarks of Microchip Technology Inc. in other countries.

GestIC is a registered trademark of Microchip Technology Germany II GmbH & Co. KG, a subsidiary of Microchip Technology Inc., in other countries.

All other trademarks mentioned herein are property of their respective companies.

© 2019, Microchip Technology Incorporated, All Rights Reserved.

ISBN: 978-1-5224-5370-3

For information regarding Microchip's Quality Management Systems, please visit [www.microchip.com/quality](http://www.microchip.com/quality).



# MICROCHIP

## Worldwide Sales and Service

### AMERICAS

**Corporate Office**  
2355 West Chandler Blvd.  
Chandler, AZ 85224-6199  
Tel: 480-792-7200  
Fax: 480-792-7277  
Technical Support:  
<http://www.microchip.com/support>  
Web Address:  
[www.microchip.com](http://www.microchip.com)

#### Atlanta

Duluth, GA  
Tel: 678-957-9614  
Fax: 678-957-1455

#### Austin, TX

Tel: 512-257-3370

#### Boston

Westborough, MA  
Tel: 774-760-0087  
Fax: 774-760-0088

#### Chicago

Itasca, IL  
Tel: 630-285-0071  
Fax: 630-285-0075

#### Dallas

Addison, TX  
Tel: 972-818-7423  
Fax: 972-818-2924

#### Detroit

Novi, MI  
Tel: 248-848-4000

#### Houston, TX

Tel: 281-894-5983

#### Indianapolis

Noblesville, IN  
Tel: 317-773-8323  
Fax: 317-773-5453  
Tel: 317-536-2380

#### Los Angeles

Mission Viejo, CA  
Tel: 949-462-9523  
Fax: 949-462-9608  
Tel: 951-273-7800

#### Raleigh, NC

Tel: 919-844-7510

#### New York, NY

Tel: 631-435-6000

#### San Jose, CA

Tel: 408-735-9110  
Tel: 408-436-4270

#### Canada - Toronto

Tel: 905-695-1980  
Fax: 905-695-2078

### ASIA/PACIFIC

**Australia - Sydney**  
Tel: 61-2-9868-6733

**China - Beijing**  
Tel: 86-10-8569-7000

**China - Chengdu**  
Tel: 86-28-8665-5511

**China - Chongqing**  
Tel: 86-23-8980-9588

**China - Dongguan**  
Tel: 86-769-8702-9880

**China - Guangzhou**  
Tel: 86-20-8755-8029

**China - Hangzhou**  
Tel: 86-571-8792-8115

**China - Hong Kong SAR**  
Tel: 852-2943-5100

**China - Nanjing**  
Tel: 86-25-8473-2460

**China - Qingdao**  
Tel: 86-532-8502-7355

**China - Shanghai**  
Tel: 86-21-3326-8000

**China - Shenyang**  
Tel: 86-24-2334-2829

**China - Shenzhen**  
Tel: 86-755-8864-2200

**China - Suzhou**  
Tel: 86-186-6233-1526

**China - Wuhan**  
Tel: 86-27-5980-5300

**China - Xian**  
Tel: 86-29-8833-7252

**China - Xiamen**  
Tel: 86-592-2388138

**China - Zhuhai**  
Tel: 86-756-3210040

### ASIA/PACIFIC

**India - Bangalore**  
Tel: 91-80-3090-4444

**India - New Delhi**  
Tel: 91-11-4160-8631

**India - Pune**  
Tel: 91-20-4121-0141

**Japan - Osaka**  
Tel: 81-6-6152-7160

**Japan - Tokyo**  
Tel: 81-3-6880-3770

**Korea - Daegu**  
Tel: 82-53-744-4301

**Korea - Seoul**  
Tel: 82-2-554-7200

**Malaysia - Kuala Lumpur**  
Tel: 60-3-7651-7906

**Malaysia - Penang**  
Tel: 60-4-227-8870

**Philippines - Manila**  
Tel: 63-2-634-9065

**Singapore**  
Tel: 65-6334-8870

**Taiwan - Hsin Chu**  
Tel: 886-3-577-8366

**Taiwan - Kaohsiung**  
Tel: 886-7-213-7830

**Taiwan - Taipei**  
Tel: 886-2-2508-8600

**Thailand - Bangkok**  
Tel: 66-2-694-1351

**Vietnam - Ho Chi Minh**  
Tel: 84-28-5448-2100

### EUROPE

**Austria - Wels**  
Tel: 43-7242-2244-39  
Fax: 43-7242-2244-393

**Denmark - Copenhagen**  
Tel: 45-4450-2828  
Fax: 45-4485-2829

**Finland - Espoo**  
Tel: 358-9-4520-820

**France - Paris**  
Tel: 33-1-69-53-63-20  
Fax: 33-1-69-30-90-79

**Germany - Garching**  
Tel: 49-8931-9700

**Germany - Haan**  
Tel: 49-2129-3766400

**Germany - Heilbronn**  
Tel: 49-7131-72400

**Germany - Karlsruhe**  
Tel: 49-721-625370

**Germany - Munich**  
Tel: 49-89-627-144-0  
Fax: 49-89-627-144-44

**Germany - Rosenheim**  
Tel: 49-8031-354-560

**Israel - Ra'anana**  
Tel: 972-9-744-7705

**Italy - Milan**  
Tel: 39-0331-742611  
Fax: 39-0331-466781

**Italy - Padova**  
Tel: 39-049-7625286

**Netherlands - Drunen**  
Tel: 31-416-690399  
Fax: 31-416-690340

**Norway - Trondheim**  
Tel: 47-7288-4388

**Poland - Warsaw**  
Tel: 48-22-3325737

**Romania - Bucharest**  
Tel: 40-21-407-87-50

**Spain - Madrid**  
Tel: 34-91-708-08-90  
Fax: 34-91-708-08-91

**Sweden - Gothenberg**  
Tel: 46-31-704-60-40

**Sweden - Stockholm**  
Tel: 46-8-5090-4654

**UK - Wokingham**  
Tel: 44-118-921-5800  
Fax: 44-118-921-5820



# Mouser Electronics

Authorized Distributor

Click to View Pricing, Inventory, Delivery & Lifecycle Information:

[Microchip:](#)

[LMC7101BYM5 TR](#) [LMC7101AYM5 TR](#) [LMC7101AYM5-TR](#) [LMC7101BYM5-TR](#)