



**Low Voltage Avalanche
500 mW Zener Diodes DO-35**
Qualified per MIL-PRF-19500/437

Qualified Levels:
JAN, JANTX and
JANTXV

DESCRIPTION

The 1N5518 thru 1N5546 series of 0.5 watt axial-leaded glass Zener Voltage Regulators provides a selection from 3.3 to 33 volts with tolerances ranging from plus/minus 1% to 20%. The standard tolerance is plus/minus 5% with the B suffix unless ordered otherwise. These axial-leaded glass DO-35 Zeners are also available with an internal metallurgical bond option. This type of bonded Zener package construction is also available in JAN, JANTX, and JANTXV military qualifications. Microsemi also offers numerous other Zener products to meet higher and lower power applications.

Important: For the latest information, visit our website <http://www.microsemi.com>.

FEATURES

- JEDEC registered 1N5518 thru 1N5546.
- Voltage tolerances of plus/minus 20%, 10%, 5%, 2%, and 1% available. See [Note 1](#) on page 3.
- Internal metallurgical bond option available with "-1" suffix.
- JAN, JANTX, and JANTXV qualification per MIL-PRF-19500/437 available (requires metallurgical bond option as well as plus/minus 5% voltage tolerance or tighter with B-1, C-1 or D-1 suffix).
- RoHS compliant versions available (commercial grade only).

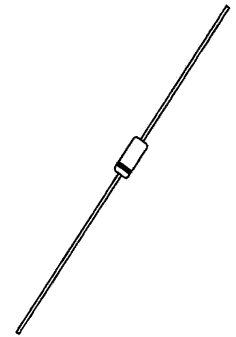

**DO-35 (DO-204AH)
Package**

Also available in:

DO-213AA MELF
(surface mount)

 [1N5518BUR-1 thru
1N5546BUR-1](#)

APPLICATIONS / BENEFITS

- Regulates voltage over a broad operating current and temperature range.
- Guaranteed voltage regulation (ΔV_Z) from I_{ZL} to I_{ZT} .
- Voltage selection from 3.3 to 33 V.
- Flexible axial-lead mounting terminals.
- Nonsensitive to ESD per MIL-STD-750 Method 1020.
- Minimal capacitance (see [Figure 3](#)).
- Inherently radiation hard as described in Microsemi "[MicroNote 050](#)" which is available at Microsemi.com.

MAXIMUM RATINGS

Parameters/Test Conditions	Symbol	Value	Unit
Junction and Storage Temperature	T_J and T_{STG}	-65 to +175	°C
Steady-State Power ^(Note 1) (Also see derating in Figure 2)	P_D	0.5	W
Thermal Resistance Junction-to-Lead ^(Note 2)	$R_{\theta JL}$	250	°C/W
Thermal Resistance Junction-to-Ambient ^(Note 3)	$R_{\theta JA}$	300	°C/W
Forward Voltage @ 200 mA	V_F	1.1	V
Solder Pad Temperature @ 10 s	T_{SP}	260	°C

- Notes:**
1. At $T_L \leq 50$ °C 3/8 inch (10 mm) from body or 0.48 W at $T_A \leq 25$ °C when mounted on FR4 PC board as described for thermal resistance above.
 2. At 3/8 (10 mm) lead length from body.
 3. When mounted on FR4 PC board (1 oz Cu) with 4 mm² copper pads and track width 1 mm, length 25 mm.

MSC – Lawrence
6 Lake Street,
Lawrence, MA 01841
1-800-446-1158
(978) 620-2600
Fax: (978) 689-0803

MSC – Ireland
Gort Road Business Park,
Ennis, Co. Clare, Ireland
Tel: +353 (0) 65 6840044
Fax: +353 (0) 65 6822298

Website:
www.microsemi.com

MECHANICAL and PACKAGING

- CASE: Hermetically sealed axial-lead glass DO-35 (DO-204AH) package.
- TERMINALS: Leads, tin-lead plated solderable per MIL-STD-750, method 2026. RoHS compliant matte-Tin available for commercial only.
- POLARITY: Cathode indicated by band where diode is to be operated with the banded end positive with respect to the opposite end for Zener regulation.
- MARKING: Part number.
- TAPE & REEL option: Standard per EIA-296 (add "TR" suffix to part number). Consult factory for quantities.
- WEIGHT: 0.2 grams.
- See [Package Dimensions](#) on last page.

PART NOMENCLATURE

JAN 1N5518 B -1 (e3)

Reliability Level

JAN = JAN Level
 JANTX = JANTX Level
 JANTXV = JANTXV Level
 Blank = Commercial

JEDEC type number

(see [Electrical Characteristic](#) table)

Zener Voltage Tolerance

A = 10%
 B = 5%
 C = 2%
 D = 1%
 Blank = 20%

RoHS Compliance

e3 = RoHS compliant ([available on commercial grade only](#))
 Blank = non-RoHS compliant

Metallurgical Bond

-1 = Metallurgical bond
 blank = Standard bond

SYMBOLS & DEFINITIONS

Symbol	Definition
I_R	Reverse Current: The maximum reverse (leakage) current that will flow at the specified voltage and temperature.
I_Z, I_{ZT}, I_{ZK}	Regulator Current: The dc regulator current (I_Z), at a specified test point (I_{ZT}), near breakdown knee (I_{ZK}).
I_{ZL}	Low Regulator (Zener) Current: The lowest rated dc current for the specified power rating.
I_{ZM}	Maximum Regulator (Zener) Current: The maximum rated dc current for the specified power rating.
V_Z	Zener Voltage: The zener voltage the device will exhibit at a specified current (I_Z) in its breakdown region.
ΔV_Z	Voltage Regulation: The change in zener voltage between two specified currents or percentage of I_{ZM} .
Z_{ZT} or Z_{ZK}	Dynamic Impedance: The small signal impedance of the diode when biased to operate in its breakdown region at a specified rms current modulation (typically 10% of I_{ZT} or I_{ZK}) and superimposed on I_{ZT} or I_{ZK} respectively.

ELECTRICAL CHARACTERISTICS

 (T_A = 25°C unless otherwise noted. Based on DC measurements at thermal equilibrium; V_F = 1.1 Max @ I_F = 200 mA for all types.)

JEDEC TYPE NUMBER (Note 1)	NOMINAL ZENER VOLTAGE V _Z @ I _{ZT} (Note 2)	TEST CURRENT I _{ZT} mA	MAX. ZENER IMPEDANCE B-C-D SUFFIX Z _{ZT} @ I _{ZT} (Note 3)	MAX. REVERSE LEAKAGE CURRENT (Note 4)			B-C-D SUFFIX MAXIMUM DC ZENER CURRENT I _{ZM} (Note 5) mAdc	B-C-D SUFFIX MAX. NOISE DENSITY AT I _Z = 250μA N _D μV/√Hz	REGULATION FACTOR ΔV _Z (Note 6) Volts	LOW V _Z CURRENT I _{ZL} (Note 6) mA
				I _R μA	V _R – Volts					
					NON & A-SUFFIX	B-C-D SUFFIX				
1N5518	3.3	20	26	5.0	0.90	1.0	115	0.5	0.90	2.0
1N5519	3.6	20	24	3.0	0.90	1.0	105	0.5	0.90	2.0
1N5520	3.9	20	22	1.0	0.90	1.0	98	0.5	0.85	2.0
1N5521	4.3	20	18	3.0	1.0	1.5	88	0.5	0.75	2.0
1N5522	4.7	10	22	2.0	1.5	2.0	81	0.5	0.60	1.0
1N5523	5.1	5.0	26	2.0	2.0	2.5	75	0.5	0.65	0.25
1N5524	5.6	3.0	30	2.0	3.0	3.5	68	1.0	0.30	0.25
1N5525	6.2	1.0	30	1.0	4.5	5.0	61	1.0	0.20	0.01
1N5526	6.8	1.0	30	1.0	5.5	6.2	56	1.0	0.10	0.01
1N5527	7.5	1.0	35	0.5	6.0	6.8	51	2.0	0.05	0.01
1N5528	8.2	1.0	40	0.5	6.5	7.5	46	4.0	0.05	0.01
1N5529	9.1	1.0	45	0.1	7.0	8.2	42	4.0	0.05	0.01
1N5530	10.0	1.0	60	0.05	8.0	9.1	38	4.0	0.10	0.01
1N5531	11.0	1.0	80	0.05	9.0	9.9	35	5.0	0.20	0.01
1N5532	12.0	1.0	90	0.05	9.5	10.8	32	10	0.20	0.01
1N5533	13.0	1.0	90	0.01	10.5	11.7	29	15	0.20	0.01
1N5534	14.0	1.0	100	0.01	11.5	12.6	27	20	0.20	0.01
1N5535	15.0	1.0	100	0.01	12.5	13.5	25	20	0.20	0.01
1N5536	16.0	1.0	100	0.01	13.0	14.4	24	20	0.20	0.01
1N5537	17.0	1.0	100	0.01	14.0	15.3	22	20	0.20	0.01
1N5538	18.0	1.0	100	0.01	15.0	16.2	21	20	0.20	0.01
1N5539	19.0	1.0	100	0.01	16.0	17.1	20	20	0.20	0.01
1N5540	20.0	1.0	100	0.01	17.0	18.0	19	20	0.20	0.01
1N5541	22.0	1.0	100	0.01	18.0	19.8	17	25	0.25	0.01
1N5542	24.0	1.0	100	0.01	20.0	21.6	16	30	0.30	0.01
1N5543	25.0	1.0	100	0.01	21.0	22.4	15	35	0.35	0.01
1N5544	28.0	1.0	100	0.01	23.0	25.2	14	40	0.40	0.01
1N5545	30.0	1.0	100	0.01	24.0	27.0	13	45	0.45	0.01
1N5546	33.0	1.0	100	0.01	28.0	29.7	12	50	0.50	0.01

NOTES:

- TOLERANCE AND VOLTAGE DESIGNATION –**
The JEDEC type numbers shown are +/-20% with guaranteed limits for only V_Z, I_R, and V_F. Units with A suffix are +/-10% with guaranteed limits for V_Z, I_R, and V_F. Units with guaranteed limits for all six parameters are indicated by a B suffix for +/-5.0% units, C suffix for +/-2.0% and D suffix for +/-1.0%.
- ZENER VOLTAGE (V_Z) MEASUREMENT –**
Nominal zener voltage is measured with the device junction in thermal equilibrium with ambient temperature of 25 °C.
- ZENER IMPEDANCE (Z_Z) MEASUREMENT –**
The zener impedance is derived from the 60 Hz ac voltage, which results when an ac current having an rms value equal to 10% of the dc zener current (I_{ZT}) is superimposed on I_{ZT}.
- REVERSE LEAKAGE CURRENT (I_R) –**
Reverse leakage currents are guaranteed and are measured at V_R as shown on the table.
- MAXIMUM REGULATOR CURRENT (I_{ZM}) –**
The maximum current shown is as shown in MIL-PRF-19500/437.
- MAXIMUM REGULATION FACTOR (ΔV_Z) –**
ΔV_Z is the maximum difference between V_Z at I_{ZT} and V_Z at I_{ZL} measured with the device junction in thermal equilibrium.

GRAPHS

Noise density, (N_b) is specified in microvolts rms per square-root-hertz ($\mu V/\sqrt{Hz}$). Actual measurement is performed using a 1 kHz to 3 kHz frequency bandpass filter with a constant Zener test current (I_{ZT}) at 25 °C ambient temperature.

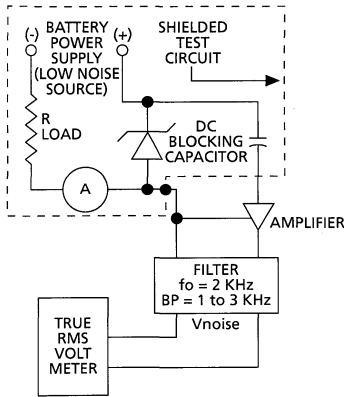

FIGURE 1

Noise Density Measurement Circuit

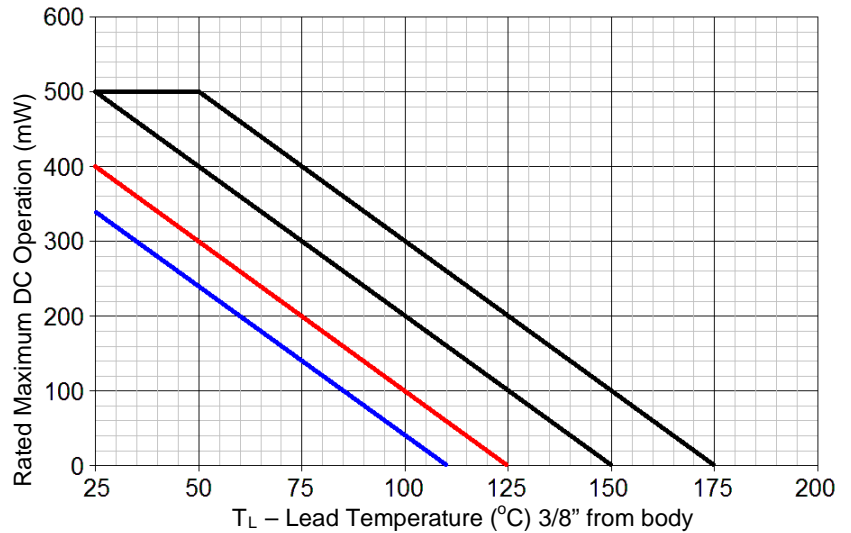

FIGURE 2 – Temperature-Power Derating Curve

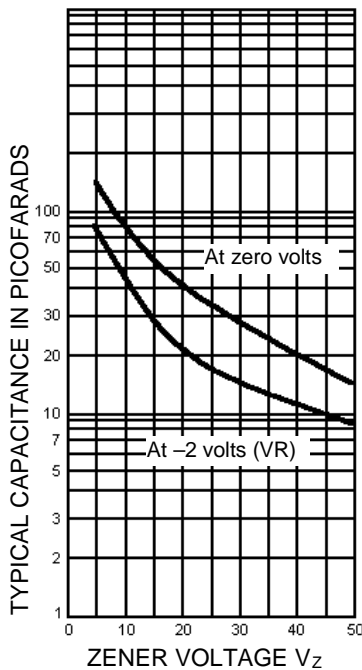

FIGURE 3

Capacitance vs. Zener Voltage (TYPICAL)

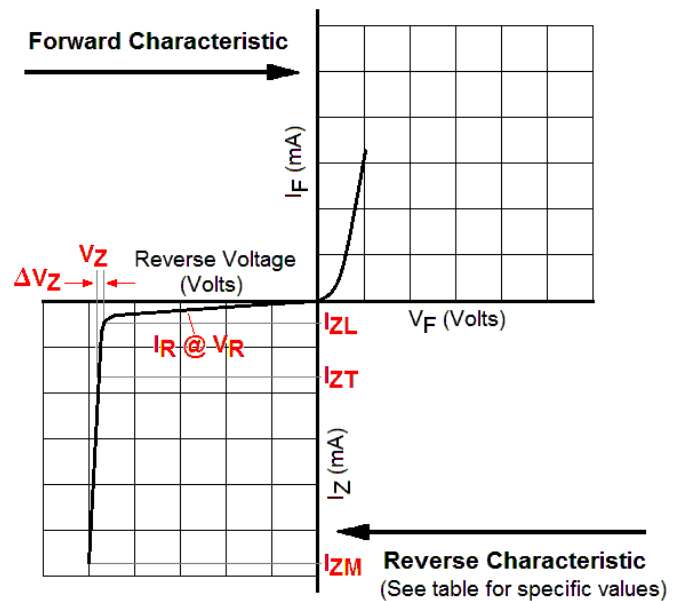
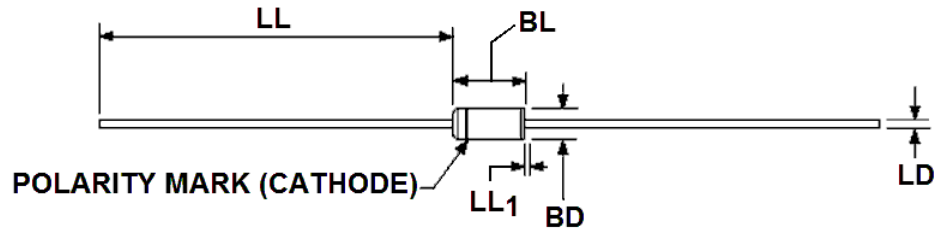

FIGURE 4

Zener Diode Characteristics and Symbol Identification

PACKAGE DIMENSIONS

Ltr	Dimensions				Notes
	Inch		Millimeters		
	Min	Max	Min	Max	
BD	.055	.090	1.40	2.29	3
BL	.120	.200	3.05	5.08	3
LD	.018	.022	0.46	0.56	
LL	1.000	1.500	25.40	38.10	
LL₁		.050		1.27	4

NOTES:

1. Dimensions are in inch.
2. Millimeters are given for general information only.
3. Package contour optional within BD and length BL. Heat slugs, if any, shall be included within this cylinder but shall not be subject to minimum limit of BD. The BL dimension shall include the entire body including slugs.
4. Within this zone lead, diameter may vary to allow for lead finishes and irregularities other than heat slugs.
5. In accordance with ASME Y14.5M, diameters are equivalent to Φ x symbology.

Mouser Electronics

Authorized Distributor

Click to View Pricing, Inventory, Delivery & Lifecycle Information:

Microchip:

[JANTX1N5530B-1](#) [JANTX1N5526B-1](#) [JANTX1N5523B-1](#) [1N5541B](#) [1N5546B](#) [1N5520B \(DO35\)](#) [1N5521B \(DO35\)](#)
[1N5518B \(DO35\)](#) [1N5526B \(DO35\)](#) [1N5524B \(DO35\)](#) [1N5522B \(DO35\)](#) [1N5527B \(DO35\)](#) [1N5519B \(DO35\)](#)
[1N5543B](#) [1N5542B](#) [1N5529B \(DO35\)](#) [1N5528B \(DO35\)](#) [1N5540B](#) [1N5545B](#) [1N5544B](#) [1N5525B \(DO35\)](#) [1N5538B](#)
[1N5533B](#) [1N5535B](#) [1N5537B](#) [1N5536B](#) [1N5534B](#) [1N5539B](#) [JANTX1N5523D-1](#) [JANTX1N5532B-1](#) [1N5532B](#)
[1N5531B](#) [1N5530B](#) [1N5529B](#) [1N5524B](#) [1N5528B](#) [1N5522B](#) [1N5523B-1](#) [1N5520B](#) [1N5519B](#) [1N5518B](#) [1N5521B](#)
[1N5525B](#) [1N5527B](#) [1N5532B \(DO35\)](#) [1N5531B \(DO35\)](#) [1N5530B \(DO35\)](#) [JANTX1N5545B-1](#) [JANTXV1N5523B-1](#)
[JAN1N5519B-1](#) [JANTXV1N5545B-1](#) [JANTXV1N5534B-1](#) [JANTXV1N5520B-1](#) [JAN1N5524B-1](#) [JANTX1N5519B-1](#)
[JAN1N5535B-1](#) [JAN1N5538B-1](#) [JANTX1N5518B-1](#) [JANTXV1N5532B-1](#) [JAN1N5530B-1](#) [JAN1N5544B-1](#)
[JANTXV1N5541B-1](#) [JANTXV1N5526B-1](#) [JANTXV1N5543B-1](#) [JANTX1N5531B-1](#) [JANTXV1N5521B-1](#)
[JANTXV1N5537B-1](#) [JANTXV1N5546B-1](#) [JANTX1N5529B-1](#) [JAN1N5533B-1](#) [JANTXV1N5528B-1](#) [JAN1N5527B-1](#)
[JANTX1N5524B-1](#) [JANTX1N5528B-1](#) [JANTXV1N5542B-1](#) [JAN1N5537B-1](#) [JAN1N5529B-1](#) [JANTXV1N5530B-1](#)
[JANTXV1N5518B-1](#) [JANTX1N5533B-1](#) [JANTXV1N5529B-1](#) [JAN1N5526B-1](#) [JANTX1N5541B-1](#) [JAN1N5520B-1](#)
[JAN1N5542B-1](#) [JANTXV1N5524B-1](#) [JANTX1N5527B-1](#) [JANTXV1N5535B-1](#) [JANTX1N5537B-1](#) [JAN1N5523B-1](#)
[JAN1N5522B-1](#) [JANTXV1N5519B-1](#) [JANTX1N5543B-1](#) [JAN1N5532B-1](#) [JAN1N5539B-1](#) [JAN1N5525B-1](#)
[JANTXV1N5533B-1](#) [JAN1N5521B-1](#) [JAN1N5536B-1](#) [JANTXV1N5538B-1](#)