

EMC1182

Dual Channel 1°C Temperature Sensor with Beta Compensation and 1.8V SMBus Communications

PRODUCT FEATURES

Datasheet

General Description

The EMC1182 is a high accuracy, low cost, 1.8V System Management Bus (SMBus) compatible temperature sensor. Advanced features such as Resistance Error Correction (REC), Beta Compensation (to support CPU diodes requiring the BJT/transistor model including 65nm and lower geometry processors) and automatic diode type detection combine to provide a robust solution for complex environmental monitoring applications. The ability to communicate at 1.8V SMBus levels provides compatible I/O for the advanced processors found in today's tablet and smartphone applications.

The EMC1182 monitors two temperature channels (one external and one internal), providing $\pm 1^\circ\text{C}$ accuracy for both external and internal diode temperatures.

REC automatically eliminates the temperature error caused by series resistance allowing greater flexibility in routing thermal diodes. Frequency hopping* and analog filters ensure remote diode traces can be as far as eight (8) inches without degrading the signal. Beta Compensation eliminates temperature errors caused by low, variable beta transistors common in today's fine geometry processors. The automatic beta detection feature monitors the external diode/transistor and determines the optimum sensor settings for accurate temperature measurements regardless of processor technology. This frees the user from providing unique sensor configurations for each temperature monitoring application. These advanced features plus $\pm 1^\circ\text{C}$ measurement accuracy provide a low-cost, highly flexible and accurate solution for critical temperature monitoring applications.

Applications

- Notebook Computers
- Desktop Computers
- Industrial
- Embedded applications

Features

- Support for diodes requiring the BJT/transistor model
 - Supports 65nm and lower geometry CPU thermal diodes
- Pin and register compatible with EMC1412
- Automatically determines external diode type and optimal settings
- Resistance Error Correction
- Frequency hops the remote sample frequency to reject DC converter and other coherent noise sources*
- Consecutive Alert queue to further reduce false Alerts
- Up to 1 External Temperature Monitor
 - 25°C typ, $\pm 1^\circ\text{C}$ max accuracy ($20^\circ\text{C} < T_{\text{DIODE}} < 110^\circ\text{C}$)
 - 0.125°C resolution
 - Supports up to 2.2nF diode filter capacitor
- Internal Temperature Monitor
 - $\pm 1^\circ\text{C}$ accuracy
 - 0.125°C resolution
- 3.3V Supply Voltage
- 1.8V SMBus operation
- Programmable temperature limits for ALERT/THERM2 (85°C default high limit and 0°C default low limit) and THERM (85°C default)
- Available in small 8-pin 2mm x 3mm TDFN RoHS compliant package
- Available in small 8-pin 3mm x 3mm DFN RoHS compliant package

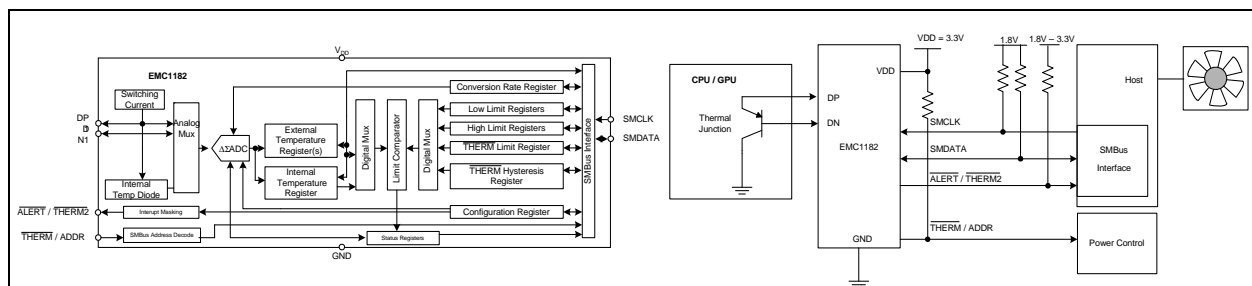

* Technology covered under the US patent 7,193,543.

Ordering Information:

ORDERING NUMBER	PACKAGE	FEATURES	SMBUS ADDRESS
EMC1182-A-AC3-TR	8-pin TDFN 2mm x 3mm (RoHS compliant)	Two temperature sensors, $\overline{\text{ALERT/THERM2}}$ and $\overline{\text{THERM}}$ pins, fixed SMBus address	Selectable via $\overline{\text{THERM}}$ pull-up
EMC1182-1-AIA-TR	8-pin DFN 3mm x 3mm (RoHS compliant)	Two temperature sensors, $\overline{\text{ALERT/THERM2}}$ and $\overline{\text{THERM}}$ pins, fixed SMBus address	1001_100(r/w)
EMC1182-1-AC3-TR	8-pin TDFN 2mm x 3mm (RoHS compliant)	Two temperature sensors, $\overline{\text{ALERT/THERM2}}$ and $\overline{\text{THERM}}$ pins, fixed SMBus address	1001_100(r/w)
EMC1182-2-AIA-TR	8-pin DFN 3mm x 3mm (RoHS compliant)	Two temperature sensors, $\overline{\text{ALERT/THERM2}}$ and $\overline{\text{THERM}}$ pins, fixed SMBus address	1001_101(r/w)
EMC1182-2-AC3-TR	8-pin TDFN 2mm x 3mm (RoHS compliant)	Two temperature sensors, $\overline{\text{ALERT/THERM2}}$ and $\overline{\text{THERM}}$ pins, fixed SMBus address	1001_101(r/w)

This product meets the halogen maximum concentration values per IEC61249-2-21

For RoHS compliance and environmental information, please visit www.smSC.com/rohs

Please contact your SMSC sales representative for additional documentation related to this product such as application notes, anomaly sheets, and design guidelines.

Copyright © 2013 SMSC or its subsidiaries. All rights reserved.

Circuit diagrams and other information relating to SMSC products are included as a means of illustrating typical applications. Consequently, complete information sufficient for construction purposes is not necessarily given. Although the information has been checked and is believed to be accurate, no responsibility is assumed for inaccuracies. SMSC reserves the right to make changes to specifications and product descriptions at any time without notice. Contact your local SMSC sales office to obtain the latest specifications before placing your product order. The provision of this information does not convey to the purchaser of the described semiconductor devices any licenses under any patent rights or other intellectual property rights of SMSC or others. All sales are expressly conditional on your agreement to the terms and conditions of the most recently dated version of SMSC's standard Terms of Sale Agreement dated before the date of your order (the "Terms of Sale Agreement"). The product may contain design defects or errors known as anomalies which may cause the product's functions to deviate from published specifications. Anomaly sheets are available upon request. SMSC products are not designed, intended, authorized or warranted for use in any life support or other application where product failure could cause or contribute to personal injury or severe property damage. Any and all such uses without prior written approval of an Officer of SMSC and further testing and/or modification will be fully at the risk of the customer. Copies of this document or other SMSC literature, as well as the Terms of Sale Agreement, may be obtained by visiting SMSC's website at <http://www.smSC.com>. SMSC is a registered trademark of Standard Microsystems Corporation ("SMSC"). Product names and company names are the trademarks of their respective holders.

The Microchip name and logo, and the Microchip logo are registered trademarks of Microchip Technology Incorporated in the U.S.A. and other countries.

SMSC DISCLAIMS AND EXCLUDES ANY AND ALL WARRANTIES, INCLUDING WITHOUT LIMITATION ANY AND ALL IMPLIED WARRANTIES OF MERCHANTABILITY, FITNESS FOR A PARTICULAR PURPOSE, TITLE, AND AGAINST INFRINGEMENT AND THE LIKE, AND ANY AND ALL WARRANTIES ARISING FROM ANY COURSE OF DEALING OR USAGE OF TRADE. IN NO EVENT SHALL SMSC BE LIABLE FOR ANY DIRECT, INCIDENTAL, INDIRECT, SPECIAL, PUNITIVE, OR CONSEQUENTIAL DAMAGES; OR FOR LOST DATA, PROFITS, SAVINGS OR REVENUES OF ANY KIND; REGARDLESS OF THE FORM OF ACTION, WHETHER BASED ON CONTRACT; TORT; NEGLIGENCE OF SMSC OR OTHERS; STRICT LIABILITY; BREACH OF WARRANTY; OR OTHERWISE; WHETHER OR NOT ANY REMEDY OF BUYER IS HELD TO HAVE FAILED OF ITS ESSENTIAL PURPOSE, AND WHETHER OR NOT SMSC HAS BEEN ADVISED OF THE POSSIBILITY OF SUCH DAMAGES.

Table of Contents

Chapter 1 Block Diagram	7
Chapter 2 Pin Description	8
Chapter 3 Electrical Specifications	10
3.1 Absolute Maximum Ratings	10
3.2 Electrical Specifications	10
3.3 SMBus Electrical Characteristics	12
Chapter 4 System Management Bus Interface Protocol	13
4.1 Communications Protocol	13
4.1.1 SMBus Start Bit	13
4.1.2 SMBus Address and RD / WR Bit	13
4.1.3 THERM Pin Considerations	14
4.1.5 SMBus Data Bytes	14
4.1.6 SMBus ACK and NACK Bits	14
4.1.7 SMBus Stop Bit	15
4.1.8 SMBus Timeout	15
4.1.9 SMBus and I ² C Compatibility	15
4.2 SMBus Protocols	15
4.2.1 Write Byte	16
4.2.2 Read Byte	16
4.2.3 Send Byte	16
4.2.4 Receive Byte	16
4.3 Alert Response Address	17
Chapter 5 Product Description	18
5.1 Modes of Operation	18
5.2 Conversion Rates	19
5.3 Dynamic Averaging	19
5.4 THERM Output	19
5.4.1 THERM Pin Considerations	20
5.5 ALERT / THERM2 Output	20
5.5.1 ALERT / THERM2 Pin InterruptALERT Mode	20
5.5.2 ALERT / THERM2 Pin ComparatorTHERM Mode	20
5.6 Temperature Measurement	21
5.6.1 Beta Compensation	21
5.6.2 Resistance Error Correction (REC)	21
5.6.3 Programmable External Diode Ideality Factor	21
5.7 Diode Faults	22
5.8 Consecutive Alerts	22
5.9 Digital Filter	22
5.10 Temperature Measurement Results and Data	24
Chapter 6 Register Description	25
6.1 Data Read Interlock	27
6.2 Temperature Data Registers	27
6.3 Status Register 02h	28

6.4 Configuration Register 03h / 09h	28
6.5 Conversion Rate Register 04h / 0Ah	29
6.6 Limit Registers	30
6.7 Scratchpad Registers 11h and 12h	31
6.8 One Shot Register 0Fh	31
6.9 Therm Limit Registers	32
6.10 Channel Mask Register 1Fh	32
6.11 Consecutive ALERT Register 22h	33
6.12 Beta Configuration Register 25h	34
6.13 External Diode Ideality Factor Register 27h	35
6.14 Filter Control Register 40h	37
6.15 Product ID Register	37
6.16 SMSC ID Register	37
6.17 Revision Register	38
<hr/>	
Chapter 7 Typical Operating Curves	39
<hr/>	
Chapter 8 Package Information	40
8.1 Package Markings	45
<hr/>	
Chapter 9 Datasheet Revision History	48

List of Figures

Figure 1.1	EMC1182 Block Diagram	7
Figure 2.1	EMC1182 Pin Diagram, TDFN-8 2mm x 3mm / DFN-8 3mm x 3mm	8
Figure 4.1	SMBus Timing Diagram	13
Figure 4.4	Isolating the THERM pin	14
Figure 5.1	System Diagram for EMC1182	18
Figure 5.2	Isolating THERM Pin	20
Figure 5.3	Isolating ALERT and SYS_SHDN Pin	21
Figure 5.4	Temperature Filter Step Response	23
Figure 5.5	Temperature Filter Impulse Response	23
Figure 8.1	2mm x 3mm TDFN Package Drawing	40
Figure 8.3	2mm x 3mm TDFN Package PCB Land Pattern	41
Figure 8.2	2mm x 3mm TDFN Package Dimensions	41
Figure 8.4	3mm x 3mm DFN Package Drawing	42
Figure 8.5	3mm x 3mm DFN Package Dimensions	43
Figure 8.6	8 Pin DFN PCB Footprint	44
Figure 8.7	EMC1182-1 8-Pin TDFN Package Markings	45
Figure 8.8	EMC1182-2 8-Pin TDFN Package Markings	45
Figure 8.9	EMC1182-A 8-Pin TDFN Package Markings	46
Figure 8.10	EMC1182-1 8-Pin DFN Package Markings	46
Figure 8.11	EMC1182-2 8-Pin DFN Package Markings	47

List of Tables

Table 2.1	EMC1182 Pin Description	8
Table 2.2	Pin Types	9
Table 3.1	Absolute Maximum Ratings	10
Table 3.2	Electrical Specifications	10
Table 3.3	SMBus Electrical Specifications	12
Table 4.1	SMBus Address Decode	13
Table 4.1	Protocol Format	15
Table 4.2	Write Byte Protocol	16
Table 4.3	Read Byte Protocol	16
Table 4.4	Send Byte Protocol	16
Table 4.5	Receive Byte Protocol	16
Table 4.6	Alert Response Address Protocol	17
Table 5.1	Supply Current vs. Conversion Rate for EMC1182	19
Table 5.2	Temperature Data Format	24
Table 6.1	Register Set in Hexadecimal Order	25
Table 6.2	Temperature Data Registers	27
Table 6.3	Status Register	28
Table 6.4	Configuration Register	28
Table 6.5	Conversion Rate Register	29
Table 6.6	Conversion Rate	30
Table 6.7	Temperature Limit Registers	30
Table 6.8	Scratchpad Register	31
Table 6.9	Therm Limit Registers	32
Table 6.10	Channel Mask Register	32
Table 6.11	Consecutive ALERT Register	33
Table 6.12	Consecutive Alert / Therm Settings	34
Table 6.13	Beta Configuration Register	34
Table 6.14	Ideality Configuration Registers	35
Table 6.15	Ideality Factor Look-Up Table (Diode Model)	35
Table 6.16	Substrate Diode Ideality Factor Look-Up Table (BJT Model)	36
Table 6.17	Filter Configuration Register	37
Table 6.18	FILTER Decode	37
Table 6.19	Product ID Register	37
Table 6.20	Manufacturer ID Register	37
Table 6.21	Revision Register	38
Table 9.1	Customer Revision History	48

Chapter 1 Block Diagram

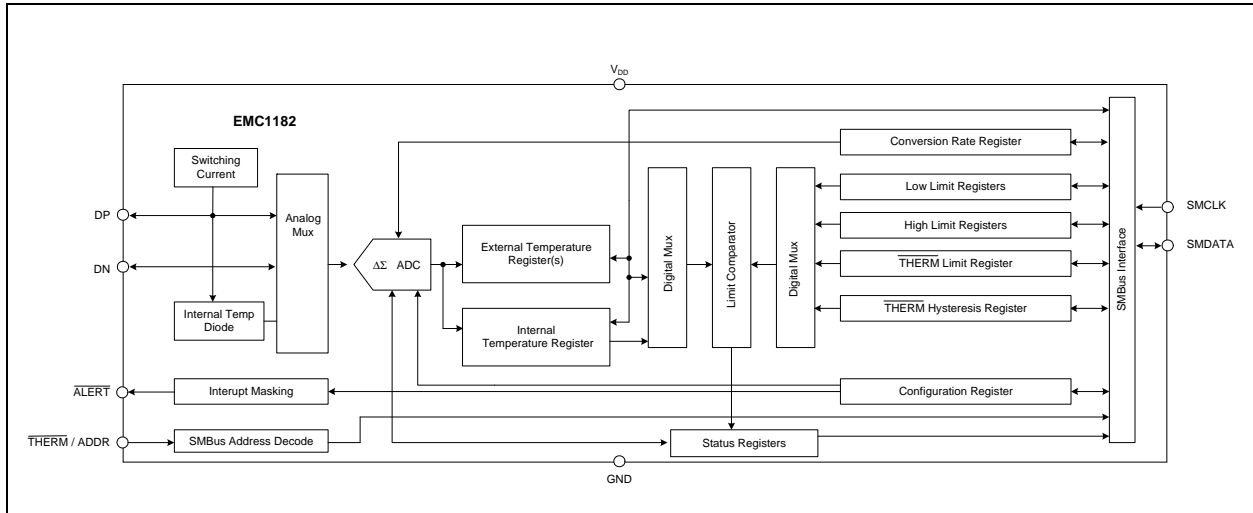

Figure 1.1 EMC1182 Block Diagram

Chapter 2 Pin Description

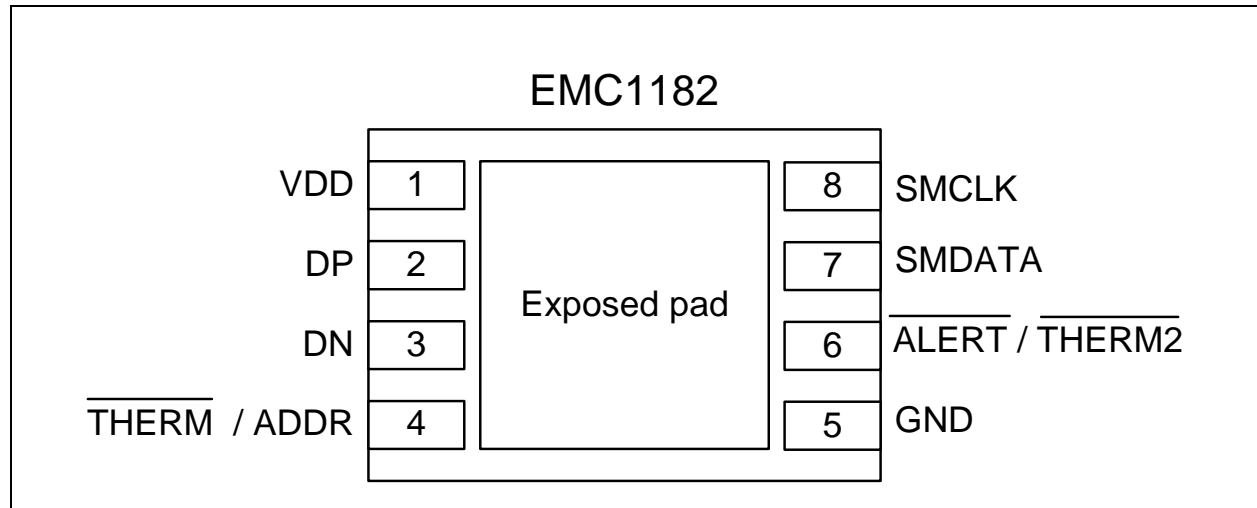

Figure 2.1 EMC1182 Pin Diagram, TDFN-8 2mm x 3mm / DFN-8 3mm x 3mm

Table 2.1 EMC1182 Pin Description

PIN NUMBER	NAME	FUNCTION	TYPE
1	VDD	Power supply	Power
2	DP	External diode positive (anode) connection	AIO
3	DN	External diode negative (cathode) connection	AIO
4	$\overline{\text{THERM}} / \text{ADDR}$	$\overline{\text{THERM}}$ - Active low Critical $\overline{\text{THERM}}$ output signal - requires pull-up resistor	OD (5V)
		ADDR - Selects SMBus address based on pull-up resistor	OD (5V)
5	GND	Ground	Power
6	$\overline{\text{ALERT}} / \overline{\text{THERM2}}$	Active low digital $\overline{\text{ALERT}} / \overline{\text{THERM2}}$ output signal - requires pull-up resistor	OD (5V)
7	SMDATA	SMBus Data input/output - requires pull-up resistor	DIOD (5V)
8	SMCLK	SMBus Clock input - requires pull-up resistor	DI (5V)
Bottom Pad	Exposed Pad	Not internally connected, but recommend grounding.	-

The pin types are described [Table 2.2](#).

Table 2.2 Pin Types

PIN TYPE	DESCRIPTION
Power	This pin is used to supply power or ground to the device.
AIO	Analog Input / Output -This pin is used as an I/O for analog signals.
DI	Digital Input - This pin is used as a digital input. This pin is 5V tolerant.
DIOD	Digital Input / Open Drain Output - This pin is used as a digital I/O. When it is used as an output, it is open drain and requires a pull-up resistor. This pin is 5V tolerant.
OD	Open Drain Digital Output - This pin is used as a digital output. It is open drain and requires a pull-up resistor. This pin is 5V tolerant.

Chapter 3 Electrical Specifications

3.1 Absolute Maximum Ratings

Table 3.1 Absolute Maximum Ratings

DESCRIPTION	RATING	UNIT
Supply Voltage (V_{DD})	-0.3 to 4.0	V
Voltage on 5V tolerant pins (V_{5VT_pin})	-0.3 to 5.5	V
Voltage on 5V tolerant pins ($(V_{5VT_pin} - V_{DD})$) (see Note 3.1)	0 to 3.6	V
Voltage on any other pin to Ground	-0.3 to $V_{DD} + 0.3$	V
Operating Temperature Range	-40 to +125	°C
Storage Temperature Range	-55 to +150	°C
Lead Temperature Range	Refer to JEDEC Spec. J-STD-020	
Package Thermal Characteristics for TDFN-8		
Thermal Resistance (θ_{j-a})	89	°C/W
ESD Rating, All pins HBM	2000	V

Note: Stresses at or above those listed could cause permanent damage to the device. This is a stress rating only and functional operation of the device at any other condition above those indicated in the operation sections of this specification is not implied.

Note 3.1 For the 5V tolerant pins that have a pull-up resistor (\overline{SMCLK} , \overline{SMDATA} , $\overline{THERM1}$, and $\overline{ALERT} / \overline{THERM2}$), the pull-up voltage must not exceed 3.6V when the device is unpowered.

3.2 Electrical Specifications

Table 3.2 Electrical Specifications

$V_{DD} = 3.0V$ to $3.6V$, $T_A = -40^\circ C$ to $125^\circ C$, all typical values at $T_A = 27^\circ C$ unless otherwise noted.						
CHARACTERISTIC	SYMBOL	MIN	TYP	MAX	UNITS	CONDITIONS
DC Power						
Supply Voltage	V_{DD}	3.0	3.3	3.6	V	
Supply Current	I_{DD}		200	410	μA	0.0625 conversion / sec, dynamic averaging disabled
			215	425	μA	1 conversion / sec, dynamic averaging disabled

Table 3.2 Electrical Specifications (continued)

V _{DD} = 3.0V to 3.6V, T _A = -40°C to 125°C, all typical values at T _A = 27°C unless otherwise noted.						
CHARACTERISTIC	SYMBOL	MIN	TYP	MAX	UNITS	CONDITIONS
			325	465	μA	4 conversions / sec, dynamic averaging disabled
			890	1050	μA	4 conversions / sec, dynamic averaging enabled
			1120		μA	≥ 16 conversions / sec, dynamic averaging enabled
Standby Supply Current	I _{DD}		170	230	μA	Device in Standby mode, no SMBus communications, ALERT and THERM pins not asserted.
Internal Temperature Monitor						
Temperature Accuracy			±0.25	±1	°C	-5°C < T _A < 100°C
				±2	°C	-40°C < T _A < 125°C
Temperature Resolution			0.125		°C	
External Temperature Monitor						
Temperature Accuracy			±0.25	±1	°C	+20°C < T _{DIODE} < +110°C 0°C < T _A < 100°C
				±0.5	±2	°C
Temperature Resolution			0.125		°C	
Conversion Time all Channels	t _{CONV}		190		ms	default settings
Capacitive Filter	C _{FILTER}		2.2	2.7	nF	Connected across external diode
$\overline{\text{ALERT}}$ / $\overline{\text{THERM2}}$ and $\overline{\text{THERM}}$ pins						
Output Low Voltage	V _{OL}	0.4			V	I _{SINK} = 8mA
Leakage Current	I _{LEAK}			±5	μA	$\overline{\text{ALERT}}$ / $\overline{\text{THERM2}}$ and $\overline{\text{SYS_SHDN}}$ pins Device powered or unpowered T _A < 85°C pull-up voltage ≤ 3.6V

3.3 SMBus Electrical Characteristics

Table 3.3 SMBus Electrical Specifications

V _{DD} = 3.0 to 3.6V, T _A = -40°C to 125°C, all typical values are at T _A = 27°C unless otherwise noted.						
CHARACTERISTIC	SYMBOL	MIN	TYP	MAX	UNITS	CONDITIONS
SMBus Interface						
Input High Voltage	V _{IH}	1.4		V _{DD}	V	5V Tolerant. Voltage threshold based on 1.8V operation
Input Low Voltage	V _{IL}	-0.3		0.8	V	5V Tolerant. Voltage threshold based on 1.8V operation
Leakage Current	I _{LEAK}			±5	µA	Powered or unpowered T _A < 85°C
Hysteresis		50			mV	
Input Capacitance	C _{IN}		5		pF	
Output Low Sink Current	I _{OL}	8.2		15	mA	SMDATA = 0.4V
SMBus Timing						
Clock Frequency	f _{SMB}	10		400	kHz	
Spike Suppression	t _{SP}			50	ns	
Bus Free Time Stop to Start	t _{BUF}	1.3			µs	
Hold Time: Start	t _{HD:STA}	0.6			µs	
Setup Time: Start	t _{SU:STA}	0.6			µs	
Setup Time: Stop	t _{SU:STO}	0.6			µs	
Data Hold Time	t _{HD:DAT}	0			µs	When transmitting to the master
Data Hold Time	t _{HD:DAT}	0.3			µs	When receiving from the master
Data Setup Time	t _{SU:DAT}	100			ns	
Clock Low Period	t _{LOW}	1.3			µs	
Clock High Period	t _{HIGH}	0.6			µs	
Clock/Data Fall time	t _{FALL}			300	ns	Min = 20+0.1C _{LOAD} ns
Clock/Data Rise time	t _{RISE}			300	ns	Min = 20+0.1C _{LOAD} ns
Capacitive Load	C _{LOAD}			400	pF	per bus line
Timeout	t _{TIMEOUT}	25		35	ms	Disabled by default

Chapter 4 System Management Bus Interface Protocol

4.1 Communications Protocol

The EMC1182 communicates with a host controller, such as an SMSC SIO, through the SMBus. The SMBus is a two-wire serial communication protocol between a computer host and its peripheral devices. A detailed timing diagram is shown in [Figure 4.1](#).

For the first 15ms after power-up the device may not respond to SMBus communications.

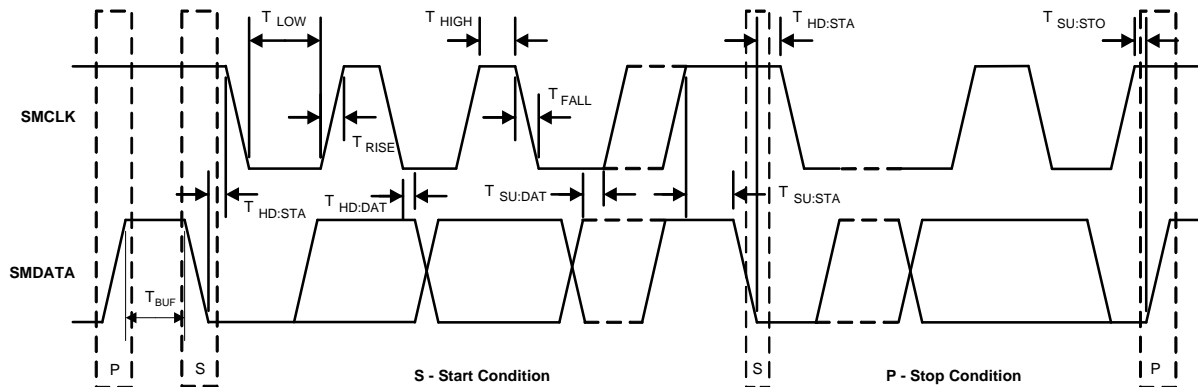

Figure 4.1 SMBus Timing Diagram

4.1.1 SMBus Start Bit

The SMBus Start bit is defined as a transition of the SMBus Data line from a logic '1' state to a logic '0' state while the SMBus Clock line is in a logic '1' state.

4.1.2 SMBus Address and $\overline{RD/WR}$ Bit

The SMBus Address Byte consists of the 7-bit client address followed by the $\overline{RD/WR}$ indicator bit. If this $\overline{RD/WR}$ bit is a logic '0', the SMBus Host is writing data to the client device. If this $\overline{RD/WR}$ bit is a logic '1', the SMBus Host is reading data from the client device.

The EMC1182-A SMBus slave address is determined by the pull-up resistor on the \overline{THERM} pin as shown in [Table 4.1](#), "SMBus Address Decode".

The Address decode is performed by pulling known currents from VDD through the external resistor causing the pin voltage to drop based on the respective current / resistor relationship. This pin voltage is compared against a threshold that determines the value of the pull-up resistor.

Table 4.1 SMBus Address Decode

PULL UP RESISTOR ON THERM PIN ($\pm 5\%$)	SMBUS ADDRESS
4.7k	1111_100(r/w)b
6.8k	1011_100(r/w)b

Table 4.1 SMBus Address Decode (continued)

PULL UP RESISTOR ON THERM PIN ($\pm 5\%$)	SMBUS ADDRESS
10k	1001_100(r/w)b
15k	1101_100(r/w)b
22k	0011_100(r/w)b
33k	0111_100(r/w)b

The EMC1182-1 SMBus address is hard coded to 1001_100(r/w).

The EMC1182-2 SMBus address is hard coded to 1001_101(r/w).

4.1.3 THERM Pin Considerations

Because of the decode method used to determine the SMBus Address, it is important that the pull-up resistance on the THERM pin be within the tolerances shown in Table 4.1. Additionally, the pull-up resistor on the THERM pin must be connected to the same 3.3V supply that drives the VDD pin.

For 15ms after power up, the THERM pin must not be pulled low or the SMBus address will not be decoded properly. If the system requirements do not permit these conditions, the THERM pin must be isolated from its hard-wired OR'd bus during this time.

One method of isolating this pin is shown in Figure 4.4, "Isolating the THERM pin".

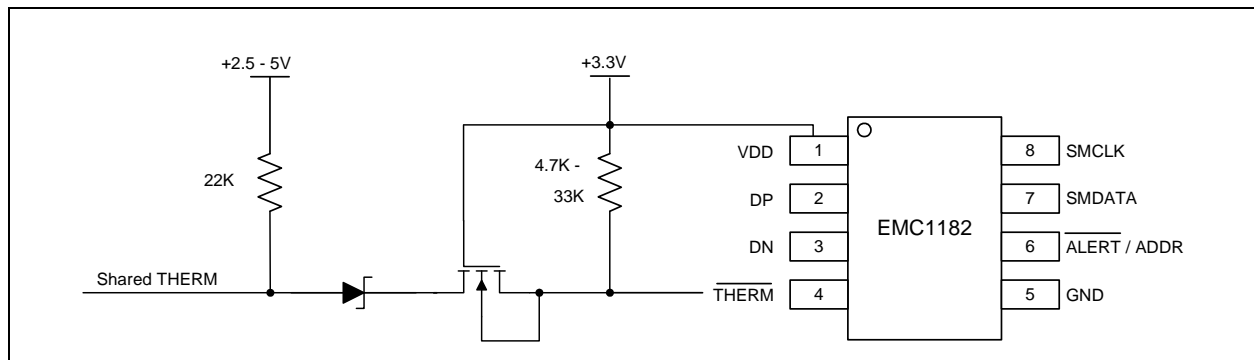
**Figure 4.4 Isolating the THERM pin**

4.1.5 SMBus Data Bytes

All SMBus Data bytes are sent most significant bit first and composed of 8-bits of information.

4.1.6 SMBus ACK and NACK Bits

The SMBus client will acknowledge all data bytes that it receives. This is done by the client device pulling the SMBus data line low after the 8th bit of each byte that is transmitted. This applies to the Write Byte protocol.

The Host will NACK (not acknowledge) the last data byte to be received from the client by holding the SMBus data line high after the 8th data bit has been sent.

4.1.7 SMBus Stop Bit

The SMBus Stop bit is defined as a transition of the SMBus Data line from a logic '0' state to a logic '1' state while the SMBus clock line is in a logic '1' state. When the device detects an SMBus Stop bit and it has been communicating with the SMBus protocol, it will reset its client interface and prepare to receive further communications.

4.1.8 SMBus Timeout

The EMC1182 supports SMBus Timeout. If the clock line is held low for longer than t_{TIMEOUT} , the device will reset its SMBus protocol. This function can be enabled by setting the TIMEOUT bit (see [Section 6.11, "Consecutive ALERT Register 22h"](#)).

4.1.9 SMBus and I²C Compatibility

The EMC1182 is compatible with SMBus and I²C. The major differences between SMBus and I²C devices are highlighted here. For more information, refer to the SMBus 2.0 and I²C specifications. For information on using the EMC1182 in an I²C system, refer to SMSC AN 14.0 SMSC Dedicated Slave Devices in I²C Systems.

1. EMC1182 supports I²C fast mode at 400kHz. This covers the SMBus max time of 100kHz.
2. Minimum frequency for SMBus communications is 10kHz.
3. The SMBus client protocol will reset if the clock is held at a logic '0' for longer than 30ms. This timeout functionality is disabled by default in the EMC1182 and can be enabled by writing to the TIMEOUT bit. I²C does not have a timeout.
4. I²C devices do not support the Alert Response Address functionality (which is optional for SMBus).

Attempting to communicate with the EMC1182 SMBus interface with an invalid slave address or invalid protocol will result in no response from the device and will not affect its register contents. Stretching of the SMCLK signal is supported, provided other devices on the SMBus control the timing.

4.2 SMBus Protocols

The device supports Send Byte, Read Byte, Write Byte, Receive Byte, and the Alert Response Address as valid protocols as shown below.

All of the below protocols use the convention in [Table 4.1](#).

Table 4.1 Protocol Format

DATA SENT TO DEVICE	DATA SENT TO THE HOST
# of bits sent	# of bits sent

4.2.1 Write Byte

The Write Byte is used to write one byte of data to the registers, as shown in [Table 4.2](#).

Table 4.2 Write Byte Protocol

START	SLAVE ADDRESS	WR	ACK	REGISTER ADDRESS	ACK	REGISTER DATA	ACK	STOP
1 -> 0	YYYY_YYY	0	0	XXh	0	XXh	0	0 -> 1

4.2.2 Read Byte

The Read Byte protocol is used to read one byte of data from the registers as shown in [Table 4.3](#).

Table 4.3 Read Byte Protocol

START	SLAVE ADDRESS	WR	ACK	REGISTER ADDRESS	ACK	START	SLAVE ADDRESS	RD	ACK	REGISTER DATA	NACK	STOP
1 -> 0	YYYY_YYY	0	0	XXh	0	1 -> 0	YYYY_YYY	1	0	XX	1	0 -> 1

4.2.3 Send Byte

The Send Byte protocol is used to set the internal address register pointer to the correct address location. No data is transferred during the Send Byte protocol as shown in [Table 4.4](#).

Table 4.4 Send Byte Protocol

START	SLAVE ADDRESS	WR	ACK	REGISTER ADDRESS	ACK	STOP
1 -> 0	YYYY_YYY	0	0	XXh	0	0 -> 1

4.2.4 Receive Byte

The Receive Byte protocol is used to read data from a register when the internal register address pointer is known to be at the right location (e.g. set via Send Byte). This is used for consecutive reads of the same register as shown in [Table 4.5](#).

Table 4.5 Receive Byte Protocol

START	SLAVE ADDRESS	RD	ACK	REGISTER DATA	NACK	STOP
1 -> 0	YYYY_YYY	1	0	XXh	1	0 -> 1

4.3 Alert Response Address

The $\overline{\text{ALERT}}$ output can be used as a processor interrupt or as an SMBus Alert.

When it detects that the $\overline{\text{ALERT}}$ pin is asserted, the host will send the Alert Response Address (ARA) to the general address of 0001_100xb. All devices with active interrupts will respond with their client address as shown in [Table 4.6](#).

Table 4.6 Alert Response Address Protocol

START	ALERT RESPONSE ADDRESS	RD	ACK	DEVICE ADDRESS	NACK	STOP
1 -> 0	0001_100	1	0	YYYY_YYY	1	0 -> 1

The EMC1182 will respond to the ARA in the following way:

1. Send Slave Address and verify that full slave address was sent (i.e. the SMBus communication from the device was not prematurely stopped due to a bus contention event).
2. Set the MASK_ALL bit to clear the $\overline{\text{ALERT}}$ pin.

APPLICATION NOTE: The ARA does not clear the Status Register and if the MASK_ALL bit is cleared prior to the Status Register being cleared, the $\overline{\text{ALERT}}$ pin will be reasserted.

Chapter 5 Product Description

The is an SMBus temperature sensor. The EMC1182 monitors one internal diode and one externally connected temperature diode.

Thermal management is performed in cooperation with a host device. This consists of the host reading the temperature data of both the external and internal temperature diodes of the EMC1182 and using that data to control the speed of one or more fans.

The EMC1182 has two levels of monitoring. The first provides a maskable $\overline{\text{ALERT}} / \overline{\text{THERM2}}$ signal to the host when the measured temperatures exceeds user programmable limits. This allows the EMC1182 to be used as an independent thermal watchdog to warn the host of temperature hot spots without direct control by the host. The second level of monitoring provides a non-maskable interrupt on the $\overline{\text{THERM}}$ pin if the measured temperatures meet or exceed a second programmable limit.

Figure 5.1 shows a system level block diagram of the EMC1182.

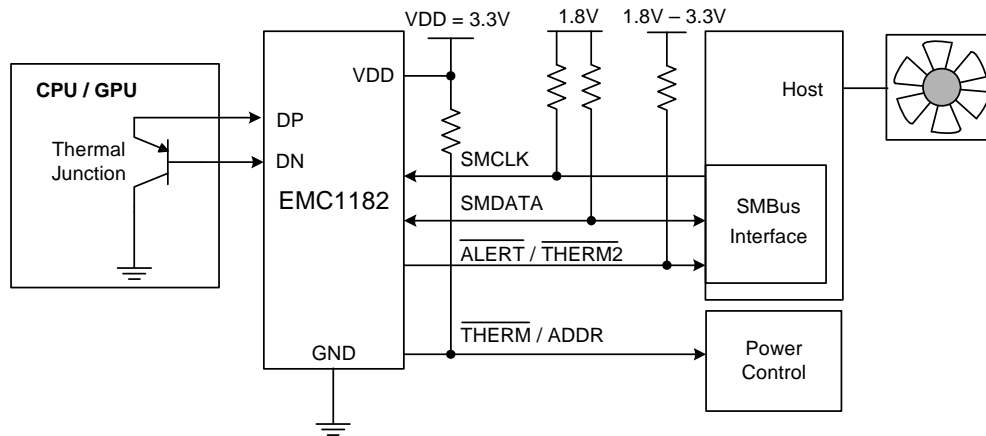

Figure 5.1 System Diagram for EMC1182

5.1 Modes of Operation

The EMC1182 has two modes of operation.

- Active (Run) - In this mode of operation, the ADC is converting on all temperature channels at the programmed conversion rate. The temperature data is updated at the end of every conversion and the limits are checked. In Active mode, writing to the one-shot register will do nothing.
- Standby (Stop) - In this mode of operation, the majority of circuitry is powered down to reduce supply current. The temperature data is not updated and the limits are not checked. In this mode of operation, the SMBus is fully active and the part will return requested data. Writing to the one-shot register will enable the device to update all temperature channels. Once all the channels are updated, the device will return to the Standby mode.

5.2 Conversion Rates

The EMC1182 may be configured for different conversion rates based on the system requirements. The conversion rate is configured as described in [Section 6.5](#). The default conversion rate is 4 conversions per second. Other available conversion rates are shown in [Table 6.6, "Conversion Rate"](#).

5.3 Dynamic Averaging

Dynamic averaging causes the EMC1182 to measure the external diode channels for an extended time based on the selected conversion rate. This functionality can be disabled for increased power savings at the lower conversion rates (see [Section 6.4, "Configuration Register 03h / 09h"](#)). When dynamic averaging is enabled, the device will automatically adjust the sampling and measurement time for the external diode channels. This allows the device to average 2x or 16x longer than the normal 11 bit operation (nominally 21ms per channel) while still maintaining the selected conversion rate. The benefits of dynamic averaging are improved noise rejection due to the longer integration time as well as less random variation of the temperature measurement.

When enabled, the dynamic averaging applies when a one-shot command is issued. The device will perform the desired averaging during the one-shot operation according to the selected conversion rate.

When enabled, the dynamic averaging will affect the average supply current based on the chosen conversion rate as shown in [Table 5.1](#).

Table 5.1 Supply Current vs. Conversion Rate for EMC1182

CONVERSION RATE	AVERAGE SUPPLY CURRENT (TYPICAL)		AVERAGING FACTOR (BASED ON 11-BIT OPERATION)	
	ENABLED (DEFAULT)	DISABLED	ENABLED (DEFAULT)	DISABLED
1 / 16 sec	210uA	200uA	16x	1x
1 / 8 sec	265uA	200uA	16x	1x
1 / 4 sec	330uA	200uA	16x	1x
1 / 2 sec	395uA	200uA	16x	1x
1 / sec	460uA	215uA	16x	1x
4 / sec (default)	890uA	325uA	8x	1x
8 / sec	1010uA	630uA	4x	1x
16 / sec	1120uA	775uA	2x	1x
32 / sec	1200uA	1050uA	1x	1x
64 / sec	1400uA	1100uA	0.5x	0.5x

5.4 THERM Output

The $\overline{\text{THERM}}$ output is asserted independently of the $\overline{\text{ALERT}}$ output and cannot be masked. Whenever any of the measured temperatures exceed the user programmed Therm Limit values for the programmed number of consecutive measurements, the THERM output is asserted. Once it has been asserted, it will remain asserted until all measured temperatures drop below the Therm Limit minus the Therm Hysteresis (also programmable).

When the $\overline{\text{THERM}}$ pin is asserted, the THERM status bits will likewise be set. Reading these bits will not clear them until the $\overline{\text{THERM}}$ pin is deasserted. Once the $\overline{\text{THERM}}$ pin is deasserted, the THERM status bits will be automatically cleared.

5.4.1 $\overline{\text{THERM}}$ Pin Considerations

Because of the decode method used to determine the SMBus Address, it is important that the pull-up resistance on $\overline{\text{THERM}}$ pin be within $\pm 10\%$ tolerance. Additionally, the pull-up resistor on the $\overline{\text{THERM}}$ pin must be connected to the same 3.3V supply that drives the VDD pin.

For 15ms after power up, the $\overline{\text{THERM}}$ pin must not be pulled low or the SMBus Address will not be decoded properly. If the system requirements do not permit these conditions, the $\overline{\text{THERM}}$ pin must be isolated from the bus during this time. One method of isolating this pin is shown in [Figure 5.2](#).

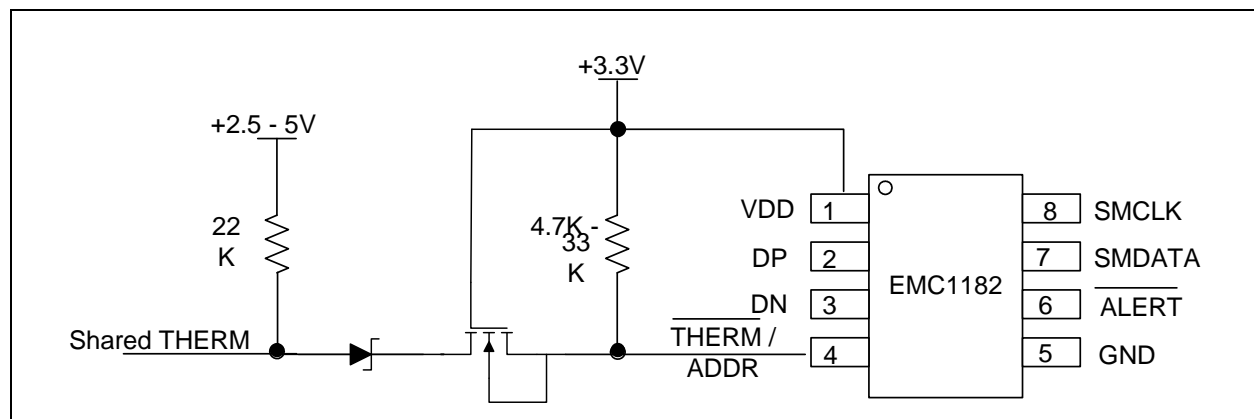

Figure 5.2 Isolating $\overline{\text{THERM}}$ Pin

5.5 $\overline{\text{ALERT}}$ / $\overline{\text{THERM2}}$ Output

The $\overline{\text{ALERT}}$ / $\overline{\text{THERM2}}$ pin is an open drain output and requires a pull-up resistor to V_{DD} and has two modes of operation: interrupt mode and comparator mode. The mode of the $\overline{\text{ALERT}}$ / $\overline{\text{THERM2}}$ output is selected via the ALERT / COMPALERT/THERM bit in the Configuration Register (see [Section 6.4](#)).

5.5.1 $\overline{\text{ALERT}}$ / $\overline{\text{THERM2}}$ Pin Interrupt $\overline{\text{ALERT}}$ Mode

When configured to operate in interrupt mode, the $\overline{\text{ALERT}}$ / $\overline{\text{THERM2}}$ pin asserts low when an out of limit measurement (\geq high limit or $<$ low limit) is detected on any diode or when a diode fault is detected, functioning as any standard ALERT in on the SMBus. The $\overline{\text{ALERT}}$ / $\overline{\text{THERM2}}$ pin will remain asserted as long as an out-of-limit condition remains. Once the out-of-limit condition has been removed, the $\overline{\text{ALERT}}$ / $\overline{\text{THERM2}}$ pin will remain asserted until the appropriate status bits are cleared.

The $\overline{\text{ALERT}}$ / $\overline{\text{THERM2}}$ pin can be masked by setting the MASK_ALL bit. Once the $\overline{\text{ALERT}}$ / $\overline{\text{THERM2}}$ pin has been masked, it will be de-asserted and remain de-asserted until the MASK_ALL bit is cleared by the user. Any interrupt conditions that occur while the $\overline{\text{ALERT}}$ / $\overline{\text{THERM2}}$ pin is masked will update the Status Register normally. There are also individual channel masks (see [Section 6.10](#)).

The $\overline{\text{ALERT}}$ / $\overline{\text{THERM2}}$ pin is used as an interrupt signal or as an SMBus Alert signal that allows an SMBus slave to communicate an error condition to the master. One or more $\overline{\text{ALERT}}$ / $\overline{\text{THERM2}}$ outputs can be hard-wired together.

5.5.2 $\overline{\text{ALERT}}$ / $\overline{\text{THERM2}}$ Pin Comparator THERM Mode

When the $\overline{\text{ALERT}}$ / $\overline{\text{THERM2}}$ pin is configured to operate in comparator mode, it will be asserted if any of the measured temperatures exceeds the respective high limit, acting as a second THERM function

in. The $\overline{\text{ALERT}} / \overline{\text{THERM2}}$ pin will remain asserted until all temperatures drop below the corresponding high limit minus the Therm Hysteresis value.

When the $\overline{\text{ALERT}} / \overline{\text{THERM2}}$ pin is asserted in comparator mode, the corresponding high limit status bits will be set. Reading these bits will not clear them until the $\overline{\text{ALERT}} / \overline{\text{THERM2}}$ pin is deasserted. Once the $\overline{\text{ALERT}}$ pin is deasserted, the status bits will be automatically cleared.

The MASK_ALL bit will not block the $\overline{\text{ALERT}} / \overline{\text{THERM2}}$ pin in this mode; however, the individual channel masks (see [Section 6.10](#)) will prevent the respective channel from asserting the $\overline{\text{ALERT}} / \overline{\text{THERM2}}$ pin.

5.6 Temperature Measurement

The EMC1182 can monitor the temperature of one externally connected diode.

The device contains programmable High, Low, and Therm limits for all measured temperature channels. If the measured temperature goes below the Low limit or above the High limit, the $\overline{\text{ALERT}}$ pin can be asserted (based on user settings). If the measured temperature meets or exceeds the Therm Limit, the THERM pin is asserted unconditionally, providing two tiers of temperature detection.

5.6.1 Beta Compensation

The EMC1182 is configured to monitor the temperature of basic diodes (e.g., 2N3904) or CPU thermal diodes. For External Diode 1, it automatically detects the type of external diode (CPU diode or diode connected transistor) and determines the optimal setting to reduce temperature errors introduced by beta variation. Compensating for this error is also known as implementing the transistor or BJT model for temperature measurement.

For discrete transistors configured with the collector and base shorted together, the beta is generally sufficiently high such that the percent change in beta variation is very small. For example, a 10% variation in beta for two forced emitter currents with a transistor whose ideal beta is 50 would contribute approximately 0.25°C error at 100°C. However for substrate transistors where the base-emitter junction is used for temperature measurement and the collector is tied to the substrate, the proportional beta variation will cause large error. For example, a 10% variation in beta for two forced emitter currents with a transistor whose ideal beta is 0.5 would contribute approximately 8.25°C error at 100°C.

5.6.2 Resistance Error Correction (REC)

Parasitic resistance in series with the external diodes will limit the accuracy obtainable from temperature measurement devices. The voltage developed across this resistance by the switching diode currents cause the temperature measurement to read higher than the true temperature. Contributors to series resistance are PCB trace resistance, on die (i.e. on the processor) metal resistance, bulk resistance in the base and emitter of the temperature transistor. Typically, the error caused by series resistance is +0.7°C per ohm. The EMC1182 automatically corrects up to 100 ohms of series resistance.

5.6.3 Programmable External Diode Ideality Factor

The EMC1182 is designed for external diodes with an ideality factor of 1.008. Not all external diodes, processor or discrete, will have this exact value. This variation of the ideality factor introduces error in the temperature measurement which must be corrected for. This correction is typically done using programmable offset registers. Since an ideality factor mismatch introduces an error that is a function of temperature, this correction is only accurate within a small range of temperatures. To provide maximum flexibility to the user, the EMC1182 provides a 6-bit register for each external diode where the ideality factor of the diode used is programmed to eliminate errors across all temperatures.

APPLICATION NOTE: When monitoring a substrate transistor or CPU diode and beta compensation is enabled, the Ideality Factor should not be adjusted. Beta Compensation automatically corrects for most ideality errors.

5.7 Diode Faults

The EMC1182 detects an open on the DP and DN pins, and a short across the DP and DN pins. For each temperature measurement made, the device checks for a diode fault on the external diode channel(s). When a diode fault is detected, the ALERT / THERM2 pin asserts (unless masked, see [Section 5.8](#)) and the temperature data reads 00h in the MSB and LSB registers (note: the low limit will not be checked). A diode fault is defined as one of the following: an open between DP and DN, a short from V_{DD} to DP, or a short from V_{DD} to DN.

If a short occurs across DP and DN or a short occurs from DP to GND, the low limit status bit is set and the ALERT / THERM2 pin asserts (unless masked). This condition is indistinguishable from a temperature measurement of 0.000°C (-64°C in extended range) resulting in temperature data of 00h in the MSB and LSB registers.

If a short from DN to GND occurs (with a diode connected), temperature measurements will continue as normal with no alerts.

5.8 Consecutive Alerts

The EMC1182 contains multiple consecutive alert counters. One set of counters applies to the ALERT / THERM2 pin and the second set of counters applies to the THERM pin. Each temperature measurement channel has a separate consecutive alert counter for each of the ALERT / THERM2 and THERM pins. All counters are user programmable and determine the number of consecutive measurements that a temperature channel(s) must be out-of-limit or reporting a diode fault before the corresponding pin is asserted.

See [Section 6.11, "Consecutive ALERT Register 22h"](#) for more details on the consecutive alert function.

5.9 Digital Filter

To reduce the effect of noise and temperature spikes on the reported temperature, the External Diode channel uses a programmable digital filter. This filter can be configured as Level 1, Level 2, or Disabled (default) (see [Section 6.14](#)). The typical filter performance is shown in [Figure 5.4](#) and [Figure 5.5](#).



Figure 5.4 Temperature Filter Step Response

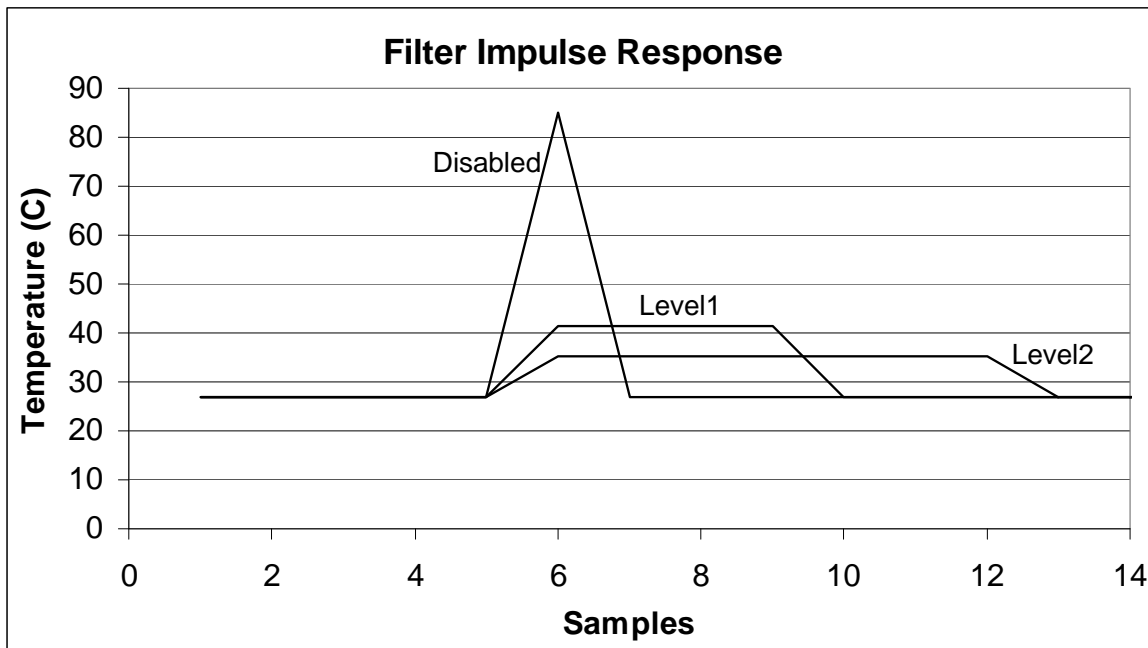

Figure 5.5 Temperature Filter Impulse Response

5.10 Temperature Measurement Results and Data

The temperature measurement results are stored in the internal and external temperature registers. These are then compared with the values stored in the high and low limit registers. Both external and internal temperature measurements are stored in 11-bit format with the eight (8) most significant bits stored in a high byte register and the three (3) least significant bits stored in the three (3) MSB positions of the low byte register. All other bits of the low byte register are set to zero.

The EMC1182 has two selectable temperature ranges. The default range is from 0°C to +127°C and the temperature is represented as binary number able to report a temperature from 0°C to +127.875°C in 0.125°C steps.

The extended range is an extended temperature range from -64°C to +191°C. The data format is a binary number offset by 64°C. The extended range is used to measure temperature diodes with a large known offset (such as AMD processor diodes) where the diode temperature plus the offset would be equivalent to a temperature higher than +127°C.

Table 5.2 shows the default and extended range formats.

Table 5.2 Temperature Data Format

TEMPERATURE (°C)	DEFAULT RANGE 0°C TO 127°C	EXTENDED RANGE -64°C TO 191°C
Diode Fault	000 0000 0000	000 0000 0000
-64	000 0000 0000	000 0000 0000
-1	000 0000 0000	001 1111 1000
0	000 0000 0000	010 0000 0000
0.125	000 0000 0001	010 0000 0001
1	000 0000 1000	010 0000 1000
64	010 0000 0000	100 0000 0000
65	010 0000 1000	100 0000 1000
127	011 1111 1000	101 1111 1000
127.875	011 1111 1111	101 1111 1111
128	011 1111 1111	110 0000 0000
190	011 1111 1111	111 1111 0000
191	011 1111 1111	111 1111 1000
>= 191.875	011 1111 1111	111 1111 1111

Chapter 6 Register Description

The registers shown in [Table 6.1](#) are accessible through the SMBus. An entry of '-' indicates that the bit is not used and will always read '0'.

Table 6.1 Register Set in Hexadecimal Order

REGISTER ADDRESS	R/W	REGISTER NAME	FUNCTION	DEFAULT VALUE	PAGE
00h	R	Internal Diode Data High Byte	Stores the integer data for the Internal Diode	00h	Page 27
01h	R	External Diode Data High Byte	Stores the integer data for the External Diode	00h	
02h	R-C	Status	Stores status bits for the Internal Diode and External Diode	00h	Page 28
03h	R/W	Configuration	Controls the general operation of the device (mirrored at address 09h)	00h	Page 28
04h	R/W	Conversion Rate	Controls the conversion rate for updating temperature data (mirrored at address 0Ah)	06h (4/sec)	Page 29
05h	R/W	Internal Diode High Limit	Stores the 8-bit high limit for the Internal Diode (mirrored at address 0Bh)	55h (85°C)	Page 30
06h	R/W	Internal Diode Low Limit	Stores the 8-bit low limit for the Internal Diode (mirrored at address 0Ch)	00h (0°C)	
07h	R/W	External Diode High Limit High Byte	Stores the integer portion of the high limit for the External Diode (mirrored at register 0Dh)	55h (85°C)	
08h	R/W	External Diode Low Limit High Byte	Stores the integer portion of the low limit for the External Diode (mirrored at register 0Eh)	00h (0°C)	
09h	R/W	Configuration	Controls the general operation of the device (mirrored at address 03h)	00h	Page 28
0Ah	R/W	Conversion Rate	Controls the conversion rate for updating temperature data (mirrored at address 04h)	06h (4/sec)	Page 29

Table 6.1 Register Set in Hexadecimal Order (continued)

REGISTER ADDRESS	R/W	REGISTER NAME	FUNCTION	DEFAULT VALUE	PAGE
0Bh	R/W	Internal Diode High Limit	Stores the 8-bit high limit for the Internal Diode (mirrored at address 05h)	55h (85°C)	Page 30
0Ch	R/W	Internal Diode Low Limit	Stores the 8-bit low limit for the Internal Diode (mirrored at address 06h)	00h (0°C)	
0Dh	R/W	External Diode High Limit High Byte	Stores the integer portion of the high limit for the External Diode (mirrored at register 07h)	55h (85°C)	
0Eh	R/W	External Diode Low Limit High Byte	Stores the integer portion of the low limit for the External Diode (mirrored at register 08h)	00h (0°C)	
0Fh	W	One Shot	A write to this register initiates a one shot update.	00h	Page 31
10h	R	External Diode Data Low Byte	Stores the fractional data for the External Diode	00h	Page 27
11h	R/W	Scratchpad	Scratchpad register for software compatibility	00h	Page 31
12h	R/W	Scratchpad	Scratchpad register for software compatibility	00h	Page 31
13h	R/W	External Diode High Limit Low Byte	Stores the fractional portion of the high limit for the External Diode	00h	Page 30
14h	R/W	External Diode Low Limit Low Byte	Stores the fractional portion of the low limit for the External Diode	00h	
19h	R/W	External Diode Therm Limit	Stores the 8-bit critical temperature limit for the External Diode	55h (85°C)	Page 32
1Fh	R/W	Channel Mask Register	Controls the masking of individual channels	00h	Page 32
20h	R/W	Internal Diode Therm Limit	Stores the 8-bit critical temperature limit for the Internal Diode	55h (85°C)	Page 32
21h	R/W	Therm Hysteresis	Stores the 8-bit hysteresis value that applies to all Therm limits	0Ah (10°C)	
22h	R/W	Consecutive ALERT	Controls the number of out-of-limit conditions that must occur before an interrupt is asserted	70h	Page 33
25h	R/W	External Diode1 Beta Configuration	Stores the Beta Compensation circuitry settings for External Diode1	08h	Page 35
27h	R/W	External Diode Ideality Factor	Stores the ideality factor for the External Diode	12h (1.008)	Page 35

Table 6.1 Register Set in Hexadecimal Order (continued)

REGISTER ADDRESS	R/W	REGISTER NAME	FUNCTION	DEFAULT VALUE	PAGE
29h	R	Internal Diode Data Low Byte	Stores the fractional data for the Internal Diode	00h	Page 27
40h	R/W	Filter Control	Controls the digital filter setting for the External Diode channel	00h	Page 37
FDh	R	Product ID	Stores a fixed value that identifies the device	20h	Page 37
FEh	R	Manufacturer ID	Stores a fixed value that represents SMSC	5Dh	Page 37
FFh	R	Revision	Stores a fixed value that represents the revision number	07h	Page 38

6.1 Data Read Interlock

When any temperature channel high byte register is read, the corresponding low byte is copied into an internal 'shadow' register. The user is free to read the low byte at any time and be guaranteed that it will correspond to the previously read high byte. Regardless if the low byte is read or not, reading from the same high byte register again will automatically refresh this stored low byte data.

6.2 Temperature Data Registers

Table 6.2 Temperature Data Registers

ADDR	R/W	REGISTER	B7	B6	B5	B4	B3	B2	B1	B0	DEFAULT
00h	R	Internal Diode High Byte	128	64	32	16	8	4	2	1	00h
29h	R	Internal Diode Low Byte	0.5	0.25	0.125	-	-	-	-	-	00h
01h	R	External Diode High Byte	128	64	32	16	8	4	2	1	00h
10h	R	External Diode Low Byte	0.5	0.25	0.125	-	-	-	-	-	00h

As shown in [Table 6.2](#), all temperatures are stored as an 11-bit value with the high byte representing the integer value and the low byte representing the fractional value left justified to occupy the MSBits.

6.3 Status Register 02h

Table 6.3 Status Register

ADDR	R/W	REGISTER	B7	B6	B5	B4	B3	B2	B1	B0	DEFAULT
02h	R-C	Status	BUSY	IHIGH	ILOW	EHIGH	ELOW	FAULT	ETHERM	ITHERM	00h

The Status Register reports the operating status of the Internal Diode and External Diode channels. When any of the bits are set (excluding the BUSY bit) either the $\overline{\text{ALERT}}$ / $\overline{\text{THERM2}}$ or $\overline{\text{THERM}}$ pin is being asserted.

The $\overline{\text{ALERT}}$ / $\overline{\text{THERM2}}$ and $\overline{\text{THERM}}$ pins are controlled by the respective consecutive alert counters (see Section 6.11) and will not be asserted until the programmed consecutive alert count has been reached. The status bits (except ETHERM and ITHERM) will remain set until read unless the $\overline{\text{ALERT}}$ pin is configured as a second $\overline{\text{THERM}}$ output (see Section 5.4).

Bit 7 - BUSY - This bit indicates that the ADC is currently converting. This bit does not cause either the $\overline{\text{ALERT}}$ / $\overline{\text{THERM2}}$ or $\overline{\text{THERM}}$ pin to be asserted.

Bit 6 - IHIGH - This bit is set when the Internal Diode channel exceeds its programmed high limit. When set, this bit will assert the $\overline{\text{ALERT}}$ / $\overline{\text{THERM2}}$ pin.

Bit 5 - ILOW - This bit is set when the Internal Diode channel drops below its programmed low limit. When set, this bit will assert the $\overline{\text{ALERT}}$ / $\overline{\text{THERM2}}$ pin.

Bit 4 - EHIGH - This bit is set when the External Diode channel exceeds its programmed high limit. When set, this bit will assert the $\overline{\text{ALERT}}$ / $\overline{\text{THERM2}}$ pin.

Bit 3 - ELOW - This bit is set when the External Diode channel drops below its programmed low limit. When set, this bit will assert the $\overline{\text{ALERT}}$ / $\overline{\text{THERM2}}$ pin.

Bit 2 - FAULT - This bit is asserted when a diode fault is detected. When set, this bit will assert the $\overline{\text{ALERT}}$ / $\overline{\text{THERM2}}$ pin.

Bit 1 - ETHERM - This bit is set when the External Diode channel exceeds the programmed Therm Limit. When set, this bit will assert the $\overline{\text{THERM}}$ pin. This bit will remain set until the $\overline{\text{THERM}}$ pin is released at which point it will be automatically cleared.

Bit 0 - ITHERM - This bit is set when the Internal Diode channel exceeds the programmed Therm Limit. When set, this bit will assert the $\overline{\text{THERM}}$ pin. This bit will remain set until the $\overline{\text{THERM}}$ pin is released at which point it will be automatically cleared.

6.4 Configuration Register 03h / 09h

Table 6.4 Configuration Register

ADDR	R/W	REGISTER	B7	B6	B5	B4	B3	B2	B1	B0	DEFAULT
03h	R/W	Configuration	MASK_ ALL	RUN/ STOP	$\overline{\text{ALERT}}/ \overline{\text{THERM2}}$	RECD	-	RANGE	DAVG_ DIS	-	00h
09h											

The Configuration Register controls the basic operation of the device. This register is fully accessible at either address.

Bit 7 - MASK_ALL - Masks the $\overline{\text{ALERT}}$ / $\overline{\text{THERM2}}$ pin from asserting.

- '0' - (default) - The $\overline{\text{ALERT}}$ / $\overline{\text{THERM2}}$ pin is not masked. If any of the appropriate status bits are set the $\overline{\text{ALERT}}$ / $\overline{\text{THERM2}}$ pin will be asserted.
- '1' - The $\overline{\text{ALERT}}$ / $\overline{\text{THERM2}}$ pin is masked. It will not be asserted for any interrupt condition unless it is configured in comparator mode. The Status Registers will be updated normally.

Bit 6 - RUN / STOP - Controls Active/Standby modes.

- '0' (default) - The device is in Active mode and converting on all channels.
- '1' - The device is in Standby mode and not converting.

Bit 5 - $\overline{\text{ALERT}}$ / $\overline{\text{THERM2}}$ - Controls the operation of the $\overline{\text{ALERT}}$ / $\overline{\text{THERM2}}$ pin.

- '0' (default) - The $\overline{\text{ALERT}}$ / $\overline{\text{THERM2}}$ acts as an Alert pin and has interrupt behavior as described in [Section 5.5.1](#).
- '1' - The $\overline{\text{ALERT}}$ / $\overline{\text{THERM2}}$ acts as a THERM pin and has comparator behavior as described in [Section 5.5.2](#). In this mode the MASK_ALL bit is ignored.

Bit 4 - RECD - Disables the Resistance Error Correction (REC) for the External Diode.

- '0' (default) - REC is enabled for the External Diode.
- '1' - REC is disabled for the External Diode.

Bit 2 - RANGE - Configures the measurement range and data format of the temperature channels.

- '0' (default) - The temperature measurement range is 0°C to +127.875°C and the data format is binary.
- '1' - The temperature measurement range is -64°C to +191.875°C and the data format is offset binary (see [Table 5.2](#)).

Bit 1 - DAVG_DIS - Disables the dynamic averaging feature on all temperature channels.

- '0' (default) - The dynamic averaging feature is enabled. All temperature channels will be converted with an averaging factor that is based on the conversion rate as shown in [Table 6.6](#).
- '1' - The dynamic averaging feature is disabled. All temperature channels will be converted with a maximum averaging factor of 1x (equivalent to 11-bit conversion). For higher conversion rates, this averaging factor will be reduced as shown in [Table 6.6](#).

6.5 Conversion Rate Register 04h / 0Ah

Table 6.5 Conversion Rate Register

ADDR	R/W	REGISTER	B7	B6	B5	B4	B3	B2	B1	B0	DEFAULT
04h	R/W	Conversion Rate	-	-	-	-	CONV[3:0]			06h (4/sec)	
0Ah											

The Conversion Rate Register controls how often the temperature measurement channels are updated and compared against the limits. This register is fully accessible at either address.

Bits 3-0 - CONV[3:0] - Determines the conversion rate as shown in [Table 6.6](#).

Table 6.6 Conversion Rate

CONV[3:0]					CONVERSIONS / SECOND
HEX	3	2	1	0	
0h	0	0	0	0	/ 16
1h	0	0	0	1	1 / 8
2h	0	0	1	0	1 / 4
3h	0	0	1	1	1 / 21
4h	0	1	0	0	1
5h	0	1	0	1	2
6h	0	1	1	0	4 (default)
7h	0	1	1	1	8
8h	1	0	0	0	16
9h	1	0	0	1	32
Ah	1	0	1	0	64
Bh - Fh	All others				1

6.6 Limit Registers

Table 6.7 Temperature Limit Registers

ADDR.	R/W	REGISTER	B7	B6	B5	B4	B3	B2	B1	B0	DEFAULT
05h	R/W	Internal Diode High Limit	128	64	32	16	8	4	2	1	55h (85°C)
0Bh											
06h	R/W	Internal Diode Low Limit	128	64	32	16	8	4	2	1	00h (0°C)
0Ch											
07h	R/W	External Diode High Limit High Byte	128	64	32	16	8	4	2	1	55h (85°C)
0Dh											
13h	R/W	External Diode High Limit Low Byte	0.5	0.25	0.125	-	-	-	-	-	00h

Table 6.7 Temperature Limit Registers (continued)

ADDR.	R/W	REGISTER	B7	B6	B5	B4	B3	B2	B1	B0	DEFAULT
08h	R/W	External Diode Low Limit High Byte	128	64	32	16	8	4	2	1	00h (0°C)
0Eh											
14h	R/W	External Diode Low Limit Low Byte	0.5	0.25	0.125	-	-	-	-	-	00h

The device contains both high and low limits for all temperature channels. If the measured temperature exceeds the high limit, then the corresponding status bit is set and the $\overline{\text{ALERT}} / \overline{\text{THERM2}}$ pin is asserted. Likewise, if the measured temperature is less than or equal to the low limit, the corresponding status bit is set and the $\overline{\text{ALERT}} / \overline{\text{THERM2}}$ pin is asserted.

The data format for the limits must match the selected data format for the temperature so that if the extended temperature range is used, the limits must be programmed in the extended data format.

The limit registers with multiple addresses are fully accessible at either address.

When the device is in Standby mode, updating the limit registers will have no effect until the next conversion cycle occurs. This can be initiated via a write to the One Shot Register (see [Section 6.8, "One Shot Register 0Fh"](#)) or by clearing the RUN / STOP bit (see [Section 6.4, "Configuration Register 03h / 09h"](#)).

6.7 Scratchpad Registers 11h and 12h

Table 6.8 Scratchpad Register

ADDR	R/W	REGISTER	B7	B6	B5	B4	B3	B2	B1	B0	DEFAULT
11h	R/W	Scratchpad	7	6	5	4	3	2	1	0	00h
12h	R/W	Scratchpad	7	6	5	4	3	2	1	0	00h

The Scratchpad Registers are Read / Write registers that are used for place holders to be software compatible with legacy programs. Reading from the registers will return what is written to them.

6.8 One Shot Register 0Fh

The One Shot Register is used to initiate a one shot command. Writing to the one shot register when the device is in Standby mode and BUSY bit (in Status Register) is '0', will immediately cause the ADC to update all temperature measurements. Writing to the One Shot Register while the device is in Active mode will have no effect.

6.9 Therm Limit Registers

Table 6.9 Therm Limit Registers

ADDR.	R/W	REGISTER	B7	B6	B5	B4	B3	B2	B1	B0	DEFAULT
19h	R/W	External Diode Therm Limit	128	64	32	16	8	4	2	1	55h (85°C)
20h	R/W	Internal Diode Therm Limit	128	64	32	16	8	4	2	1	55h (85°C)
21h	R/W	Therm Hysteresis	128	64	32	16	8	4	2	1	0Ah (10°C)

The Therm Limit Registers are used to determine whether a critical thermal event has occurred. If the measured temperature exceeds the Therm Limit, the $\overline{\text{THERM}}$ pin is asserted. The limit setting must match the chosen data format of the temperature reading registers.

Unlike the $\overline{\text{ALERT}}$ / $\overline{\text{THERM2}}$ pin, the $\overline{\text{THERM}}$ pin cannot be masked. Additionally, the $\overline{\text{THERM}}$ pin will be released once the temperature drops below the corresponding threshold minus the Therm Hysteresis.

6.10 Channel Mask Register 1Fh

Table 6.10 Channel Mask Register

ADDR.	R/W	REGISTER	B7	B6	B5	B4	B3	B2	B1	B0	DEFAULT
1Fh	R/W	Channel Mask	-	-	-	-	-	-	EXT MASK	INT MASK	00h

The Channel Mask Register controls individual channel masking. When a channel is masked, the $\overline{\text{ALERT}}$ / $\overline{\text{THERM2}}$ pin will not be asserted when the masked channel reads a diode fault or out of limit error. The channel mask does not mask the $\overline{\text{THERM}}$ pin.

Bit 1 - EXTMASK - Masks the $\overline{\text{ALERT}}$ / $\overline{\text{THERM2}}$ pin from asserting when the External Diode channel is out of limit or reports a diode fault.

- '0' (default) - The External Diode channel will cause the $\overline{\text{ALERT}}$ / $\overline{\text{THERM2}}$ pin to be asserted if it is out of limit or reports a diode fault.
- '1' - The External Diode channel will not cause the $\overline{\text{ALERT}}$ / $\overline{\text{THERM2}}$ pin to be asserted if it is out of limit or reports a diode fault.

Bit 0 - INTMASK - Masks the $\overline{\text{ALERT}}$ / $\overline{\text{THERM2}}$ pin from asserting when the Internal Diode temperature is out of limit.

- '0' (default) - The Internal Diode channel will cause the $\overline{\text{ALERT}}$ / $\overline{\text{THERM2}}$ pin to be asserted if it is out of limit.
- '1' - The Internal Diode channel will not cause the $\overline{\text{ALERT}}$ / $\overline{\text{THERM2}}$ pin to be asserted if it is out of limit.

6.11 Consecutive ALERT Register 22h

Table 6.11 Consecutive ALERT Register

ADDR.	R/W	REGISTER	B7	B6	B5	B4	B3	B2	B1	B0	DEFAULT
22h	R/W	Consecutive ALERT	TIME OUT	CTHRM[2:0]			CALRT[2:0]			-	70h

The Consecutive ALERT Register determines how many times an out-of-limit error or diode fault must be detected in consecutive measurements before the $\overline{\text{ALERT}}$ / $\overline{\text{THERM2}}$ or $\overline{\text{THERM}}$ pin is asserted. Additionally, the Consecutive ALERT Register controls the SMBus Timeout functionality.

An out-of-limit condition (i.e. HIGH, LOW, or FAULT) occurring on the same temperature channel in consecutive measurements will increment the consecutive alert counter. The counters will also be reset if no out-of-limit condition or diode fault condition occurs in a consecutive reading.

When the $\overline{\text{ALERT}}$ / $\overline{\text{THERM2}}$ pin is configured as an interrupt, when the consecutive alert counter reaches its programmed value, the following will occur: the $\overline{\text{STATUS}}$ bit(s) for that channel and the last error condition(s) (i.e. EHIGH) will be set to '1', the $\overline{\text{ALERT}}$ / $\overline{\text{THERM2}}$ pin will be asserted, the consecutive alert counter will be cleared, and measurements will continue.

When the $\overline{\text{ALERT}}$ / $\overline{\text{THERM2}}$ pin is configured as a comparator, the consecutive alert counter will ignore diode fault and low limit errors and only increment if the measured temperature exceeds the High Limit. Additionally, once the consecutive alert counter reaches the programmed limit, the $\overline{\text{ALERT}}$ / $\overline{\text{THERM2}}$ pin will be asserted, but the counter will not be reset. It will remain set until the temperature drops below the High Limit minus the Therm Hysteresis value.

For example, if the CALRT[2:0] bits are set for 4 consecutive alerts on an EMC1182 device, the high limits are set at 70°C, and none of the channels are masked, the $\overline{\text{ALERT}}$ / $\overline{\text{THERM2}}$ pin will be asserted after the following four measurements:

1. Internal Diode reads 71°C and the external diode reads 69°C. Consecutive alert counter for INT is incremented to 1.
2. Both the Internal Diode and the External Diode read 71°C. Consecutive alert counter for INT is incremented to 2 and for EXT is set to 1.
3. The External Diode reads 71°C and the Internal Diode reads 69°C. Consecutive alert counter for INT is cleared and EXT is incremented to 2.
4. The Internal Diode reads 71°C and the external diode reads 71°C. Consecutive alert counter for INT is set to 1 and EXT is incremented to 3.
5. The Internal Diode reads 71°C and the external diode reads 71°C. Consecutive alert counter for INT is incremented to 2 and EXT is incremented to 4. The appropriate status bits are set for EXT and the $\overline{\text{ALERT}}$ / $\overline{\text{THERM2}}$ pin is asserted. EXT counter is reset to 0 and all other counters hold the last value until the next temperature measurement.

Bit 7 - TIMEOUT - Determines whether the SMBus Timeout function is enabled.

- '0' (default) - The SMBus Timeout feature is disabled. The SMCLK line can be held low indefinitely without the device resetting its SMBus protocol.
- '1' - The SMBus Timeout feature is enabled. If the SMCLK line is held low for more than t_{TIMEOUT} , the device will reset the SMBus protocol.

Bits 6-4 CTHR[2:0] - Determines the number of consecutive measurements that must exceed the corresponding Therm Limit and Hardware Thermal Shutdown Limit before the $\overline{\text{SYS_SHDN}}$ pin is asserted. All temperature channels use this value to set the respective counters. The consecutive THERM counter is incremented whenever any of the measurements exceed the corresponding Therm Limit or if the External Diode measurement exceeds the Hardware Thermal Shutdown Limit.

If the temperature drops below the Therm Limit or Hardware Thermal Shutdown Limit, the counter is reset. If the programmed number of consecutive measurements exceed the Therm Limit or Hardware Thermal Shutdown Limit, and the appropriate channel is linked to the SYS_SHDN pin, the SYS_SHDN pin will be asserted low.

Once the $\overline{\text{SYS_SHDN}}$ pin is asserted, the consecutive Therm counter will not reset until the corresponding temperature drops below the appropriate limit minus the corresponding hysteresis.

Bits 6-4 - CTHRM[2:0] - Determines the number of consecutive measurements that must exceed the corresponding Therm Limit before the $\overline{\text{THERM}}$ pin is asserted. All temperature channels use this value to set the respective counters. The consecutive Therm counter is incremented whenever any measurement exceed the corresponding Therm Limit.

If the temperature drops below the Therm Limit, the counter is reset. If a number of consecutive measurements above the Therm Limit occurs, the $\overline{\text{THERM}}$ pin is asserted low.

Once the $\overline{\text{THERM}}$ pin has been asserted, the consecutive therm counter will not reset until the corresponding temperature drops below the Therm Limit minus the Therm Hysteresis value.

The bits are decoded as shown in Table 6.12. The default setting is 4 consecutive out of limit conversions.

Bits 3-1 - CALRT[2:0] - Determine the number of consecutive measurements that must have an out of limit condition or diode fault before the $\overline{\text{ALERT}}$ / $\overline{\text{THERM2}}$ pin is asserted. Both temperature channels use this value to set the respective counters. The bits are decoded as shown in Table 6.12. The default setting is 1 consecutive out of limit conversion.

Table 6.12 Consecutive Alert / Therm Settings

2	1	0	NUMBER OF CONSECUTIVE OUT OF LIMIT MEASUREMENTS
0	0	0	1 (default for CALRT[2:0])
0	0	1	2
0	1	1	3
1	1	1	4 (default for CTHRM[2:0])

6.12 Beta Configuration Register 25h

Table 6.13 Beta Configuration Register

ADDR.	R/W	REGISTER	B7	B6	B5	B4	B3	B2	B1	B0	DEFAULT
25h	R/W	External Diode Beta Configuration	-	-	-	-	ENABLE	BETA[2:0]			08h

This register is used to set the Beta Compensation factor that is used for the external diode channel.

■ '0' - The Beta Compensation Factor auto-detection circuitry is disabled.

'1' (default) - The Beta Compensation factor auto-detection circuitry is enabled. At the beginning of every conversion, the optimal Beta Compensation factor setting will be determined and applied.

6.13 External Diode Ideality Factor Register 27h

Table 6.14 Ideality Configuration Registers

ADDR.	R/W	REGISTER	B7	B6	B5	B4	B3	B2	B1	B0	DEFAULT
27h	R/W	External Diode Ideality Factor	-	-	IDEALITY[5:0]						12h

This register stores the ideality factors that are applied to the external diode. [Table 6.15](#) defines each setting and the corresponding ideality factor. Beta Compensation and Resistance Error Correction automatically correct for most diode ideality errors; therefore, it is not recommended that these settings be updated without consulting SMSC.

Table 6.15 Ideality Factor Look-Up Table (Diode Model)

SETTING	FACTOR	SETTING	FACTOR	SETTING	FACTOR
08h	0.9949	18h	1.0159	28h	1.0371
09h	0.9962	19h	1.0172	29h	1.0384
0Ah	0.9975	1Ah	1.0185	2Ah	1.0397
0Bh	0.9988	1Bh	1.0200	2Bh	1.0410
0Ch	1.0001	1Ch	1.0212	2Ch	1.0423
0Dh	1.0014	1Dh	1.0226	2Dh	1.0436
0Eh	1.0027	1Eh	1.0239	2Eh	1.0449
0Fh	1.0040	1Fh	1.0253	2Fh	1.0462
10h	1.0053	20h	1.0267	30h	1.0475
11h	1.0066	21h	1.0280	31h	1.0488
12h	1.0080	22h	1.0293	32h	1.0501
13h	1.0093	23h	1.0306	33h	1.0514
14h	1.0106	24h	1.0319	34h	1.0527
15h	1.0119	25h	1.0332	35h	1.0540
16h	1.0133	26h	1.0345	36h	1.0553
17h	1.0146	27h	1.0358	37h	1.0566

For CPU substrate transistors that require the BJT transistor model, the ideality factor behaves slightly differently than for discrete diode-connected transistors. Refer to [Table 6.16](#) when using a CPU substrate transistor.

Table 6.16 Substrate Diode Ideality Factor Look-Up Table (BJT Model)

SETTING	FACTOR	SETTING	FACTOR	SETTING	FACTOR
08h	0.9869	18h	1.0079	28h	1.0291
09h	0.9882	19h	1.0092	29h	1.0304
0Ah	0.9895	1Ah	1.0105	2Ah	1.0317
0Bh	0.9908	1Bh	1.0120	2Bh	1.0330
0Ch	0.9921	1Ch	1.0132	2Ch	1.0343
0Dh	0.9934	1Dh	1.0146	2Dh	1.0356
0Eh	0.9947	1Eh	1.0159	2Eh	1.0369
0Fh	0.9960	1Fh	1.0173	2Fh	1.0382
10h	0.9973	20h	1.0187	30h	1.0395
11h	0.9986	21h	1.0200	31h	1.0408
12h	1.0000	22h	1.0213	32h	1.0421
13h	1.0013	23h	1.0226	33h	1.0434
14h	1.0026	24h	1.0239	34h	1.0447
15h	1.0039	25h	1.0252	35h	1.0460
16h	1.0053	26h	1.0265	36h	1.0473
17h	1.0066	27h	1.0278	37h	1.0486

APPLICATION NOTE: When measuring a 65nm Intel CPU, the Ideality Setting should be the default 12h. When measuring a 45nm Intel CPU, the Ideality Setting should be 15h.

Bit 1 - E1HIGH - This bit is set when the External Diode 1 channel exceeds its programmed high limit.

Bit 0 - IHIGH - This bit is set when the Internal Diode channel exceeds its programmed high limit.

Bit 1 - ELOW - This bit is set when the External Diode channel drops below its programmed low limit.

Bit 0 - ILOW - This bit is set when the Internal Diode channel drops below its programmed low limit.

Bit 1 - ETHERM - This bit is set when the External Diode channel exceeds its programmed Therm Limit. When set, this bit will assert the $\overline{\text{THERM}}$ pin.

Bit 0 - ITHERM - This bit is set when the Internal Diode channel exceeds its programmed Therm Limit. When set, this bit will assert the $\overline{\text{THERM}}$ pin.

6.14 Filter Control Register 40h

Table 6.17 Filter Configuration Register

ADDR.	R/W	REGISTER	B7	B6	B5	B4	B3	B2	B1	B0	DEFAULT
40h	R/W	Filter Control	-	-	-	-	-	-	FILTER[1:0]		00h

The Filter Configuration Register controls the digital filter on the External Diode channel.

Bits 1-0 - FILTER[1:0] - Control the level of digital filtering that is applied to the External Diode temperature measurement as shown in Table 6.18. See Figure 5.4 and Figure 5.5 for examples on the filter behavior.

Table 6.18 FILTER Decode

FILTER[1:0]		AVERAGING
1	0	
0	0	Disabled (default)
0	1	Level 1
1	0	Level 1
1	1	Level 2

6.15 Product ID Register

Table 6.19 Product ID Register

ADDR	R/W	REGISTER	B7	B6	B5	B4	B3	B2	B1	B0	DEFAULT
FDh	R	Product ID	0	0	1	0	0	0	0	0	20h

The Product ID Register holds a unique value that identifies the device.

6.16 SMSC ID Register

Table 6.20 Manufacturer ID Register

ADDR.	R/W	REGISTER	B7	B6	B5	B4	B3	B2	B1	B0	DEFAULT
FEh	R	SMSC ID	0	1	0	1	1	1	0	1	5Dh

The Manufacturer ID register contains an 8-bit word that identifies the SMSC as the manufacturer of the EMC1182.

6.17 Revision Register

Table 6.21 Revision Register

ADDR.	R/W	REGISTER	B7	B6	B5	B4	B3	B2	B1	B0	DEFAULT
FFh	R	Revision	0	0	0	0	0	1	1	1	07h

The Revision register contains an 8-bit word that identifies the die revision.

Chapter 7 Typical Operating Curves

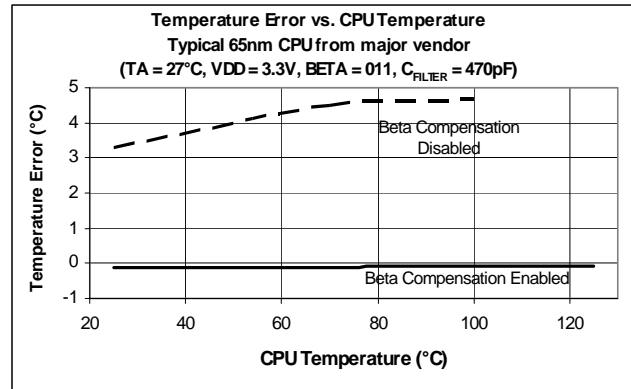
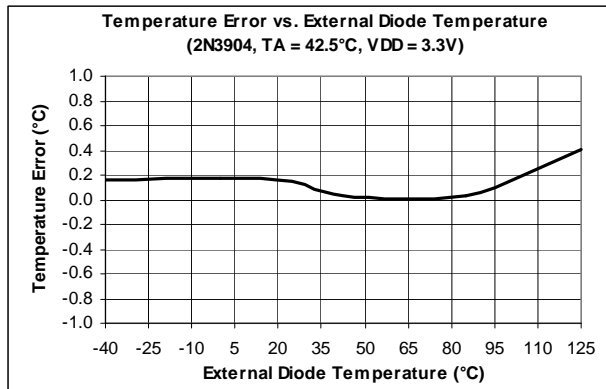
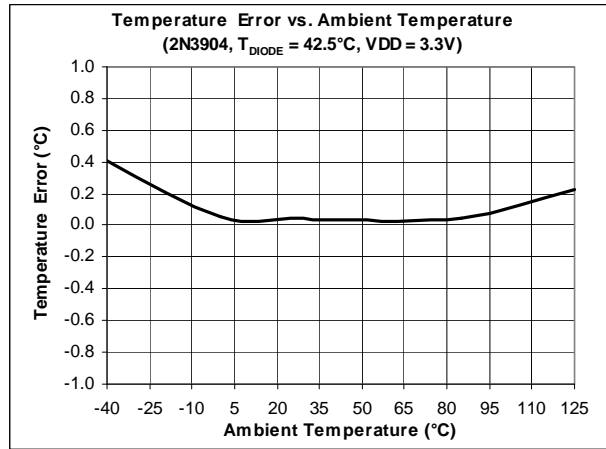
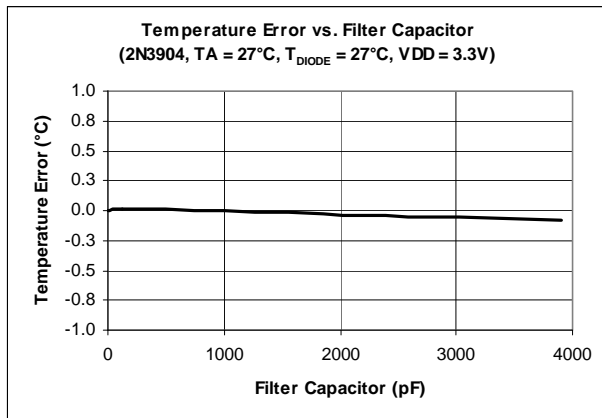

Chapter 8 Package Information

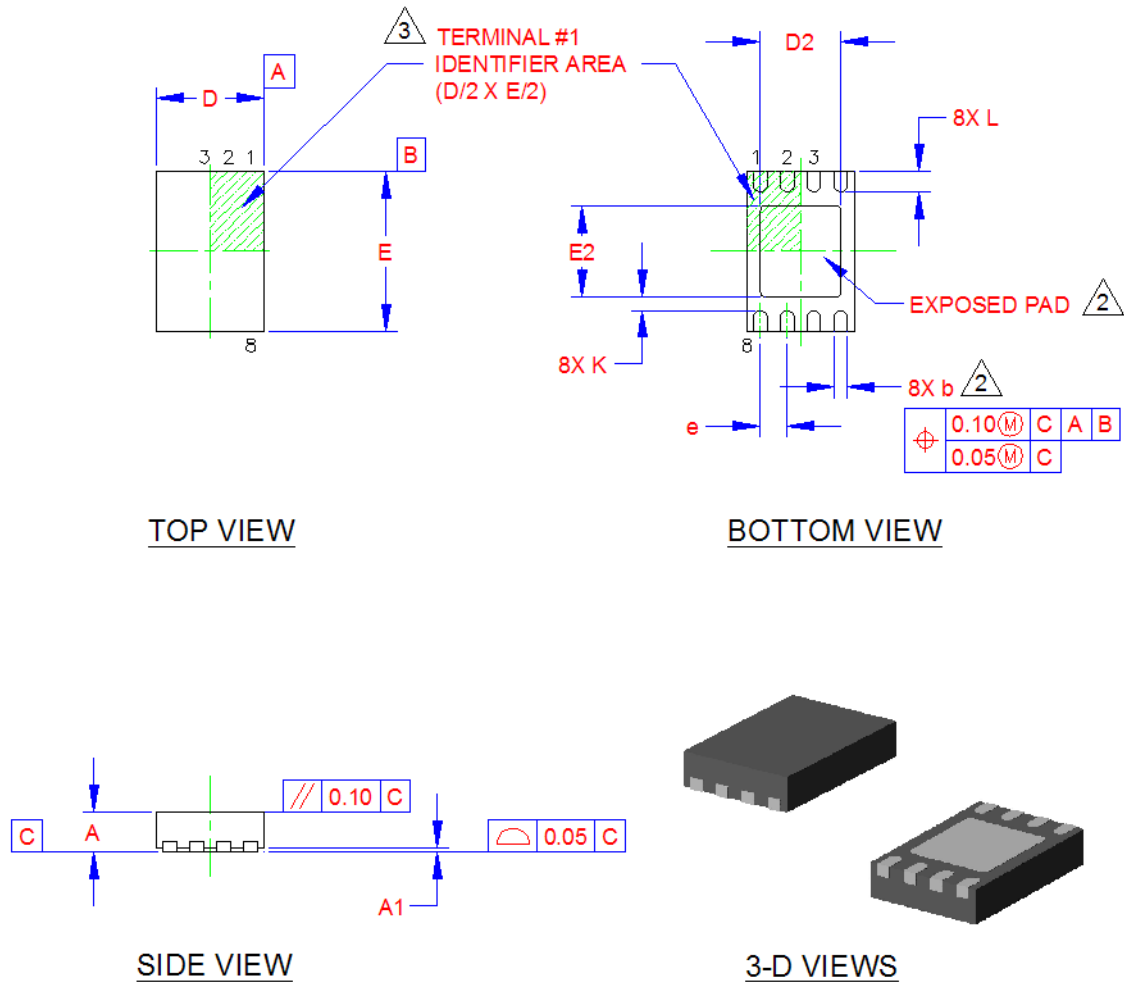

Figure 8.1 2mm x 3mm TDFN Package Drawing

COMMON DIMENSIONS					
SYMBOL	MIN	NOM	MAX	NOTE	REMARK
A	0.70	0.75	0.80	-	OVERALL PACKAGE HEIGHT
A1	0	0.02	0.05	-	STANDOFF
D	1.90	2.00	2.10	-	X BODY SIZE
E	2.90	3.00	3.10	-	Y BODY SIZE
D2	1.40	1.50	1.60	2	X EXPOSED PAD SIZE
E2	1.60	1.70	1.80	2	Y EXPOSED PAD SIZE
L	0.35	0.40	0.45	-	TERMINAL LENGTH
b	0.18	0.25	0.30	2	TERMINAL WIDTH
K	0.20	0.25	-	-	CENTER PAD TO PIN CLEARANCE
e	0.50 BSC			-	TERMINAL PITCH

NOTES:

1. ALL DIMENSIONS ARE IN MILLIMETERS.
2. UNILATERAL COPLANARITY ZONE APPLIES TO THE EXPOSED PAD, AS WELL AS THE TERMINALS. DIMENSIONS "b" APPLIES TO PLATED TERMINALS AND IT IS MEASURED BETWEEN 0.15 AND 0.30 mm FROM THE TERMINAL TIP.
3. DETAILS OF TERMINAL #1 IDENTIFIER ARE OPTIONAL BUT MUST BE LOCATED WITHIN THE AREA INDICATED.

Figure 8.2 2mm x 3mm TDFN Package Dimensions

RECOMMENDED PCB LAND PATTERN

Figure 8.3 2mm x 3mm TDFN Package PCB Land Pattern

8-Lead Plastic Dual Flat, No Lead Package (MF) - 3x3x0.9mm Body [DFN]

Note: For the most current package drawings, please see the Microchip Packaging Specification located at <http://www.microchip.com/packaging>

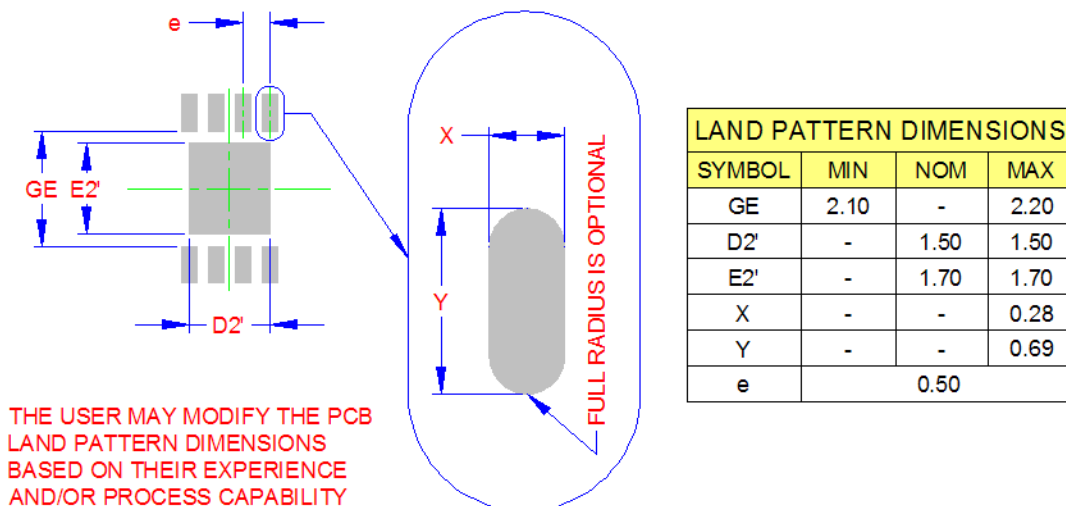
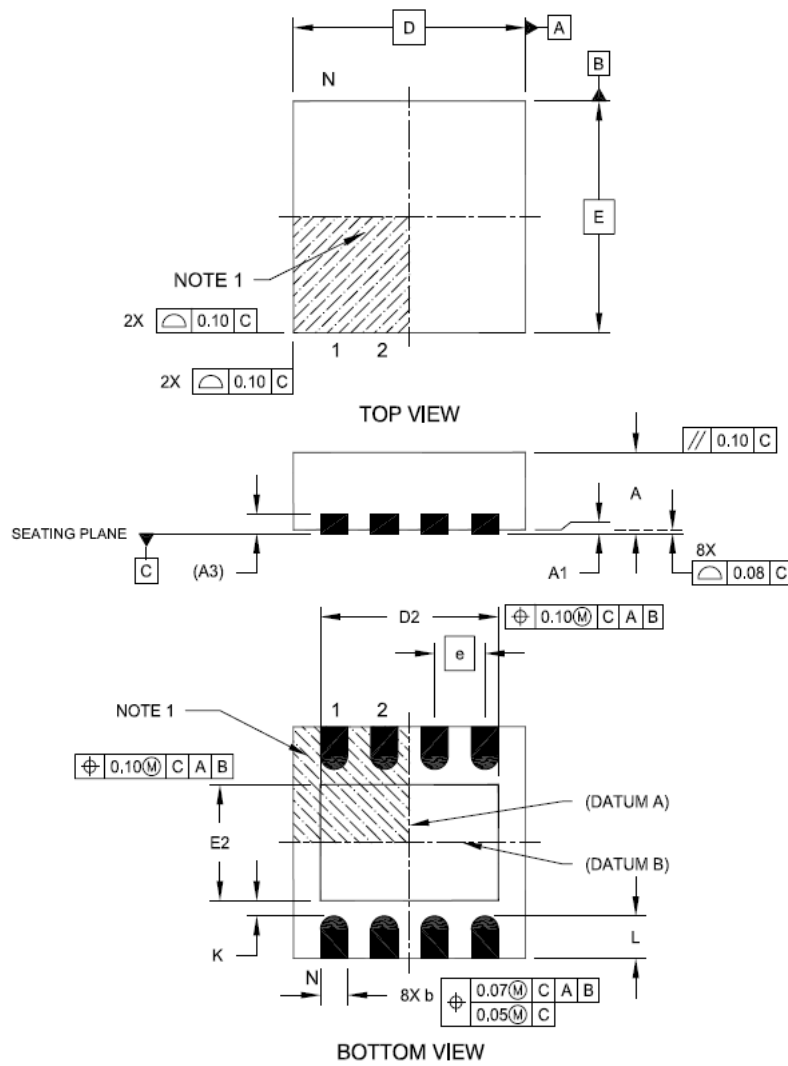
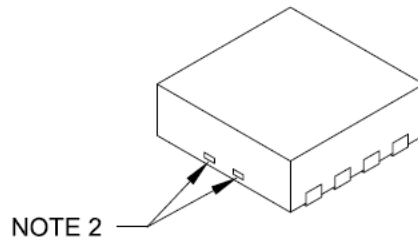

Figure 8.4 3mm x 3mm DFN Package Drawing

8-Lead Plastic Dual Flat, No Lead Package (MF) - 3x3x0.9mm Body [DFN]

Note: For the most current package drawings, please see the Microchip Packaging Specification located at <http://www.microchip.com/packaging>



Dimension Limits	Units	MILLIMETERS		
		MIN	NOM	MAX
Number of Pins	N	8		
Pitch	e	0.65 BSC		
Overall Height	A	0.80	0.90	1.00
Standoff	A1	0.00	0.02	0.05
Contact Thickness	A3	0.20 REF		
Overall Length	D	3.00 BSC		
Exposed Pad Width	E2	1.34	-	1.60
Overall Width	E	3.00 BSC		
Exposed Pad Length	D2	1.60	-	2.40
Contact Width	b	0.25	0.30	0.35
Contact Length	L	0.20	0.30	0.55
Contact-to-Exposed Pad	K	0.20	-	-

Notes:

- Pin 1 visual Index feature may vary, but must be located within the hatched area.
- Package may have one or more exposed tie bars at ends.
- Package is saw singulated
- Dimensioning and tolerancing per ASME Y14.5M

BSC: Basic Dimension. Theoretically exact value shown without tolerances.

REF: Reference Dimension, usually without tolerance, for information purposes only.

Figure 8.5 3mm x 3mm DFN Package Dimensions

8-Lead Plastic Dual Flat, No Lead Package (MF) - 3x3x0.9mm Body [DFN]

Note: For the most current package drawings, please see the Microchip Packaging Specification located at <http://www.microchip.com/packaging>

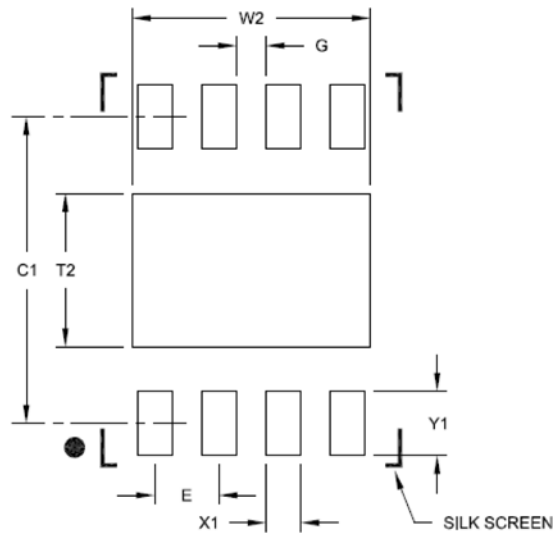

RECOMMENDED LAND PATTERN

Dimension Limits	Units	MILLIMETERS		
		MIN	NOM	MAX
Contact Pitch	E	0.65 BSC		
Optional Center Pad Width	W2			2.40
Optional Center Pad Length	T2			1.55
Contact Pad Spacing	C1		3.10	
Contact Pad Width (X8)	X1			0.35
Contact Pad Length (X8)	Y1			0.65
Distance Between Pads	G	0.30		

Notes:

1. Dimensioning and tolerancing per ASME Y14.5M
BSC: Basic Dimension, Theoretically exact value shown without tolerances.

Figure 8.6 8 Pin DFN PCB Footprint

8.1 Package Markings

The EMC1182 devices will be marked as shown in [Figure 8.7](#), [Figure 8.8.](#), [Figure 8.9](#), [Figure 8.10](#) and [Figure 8.11](#).

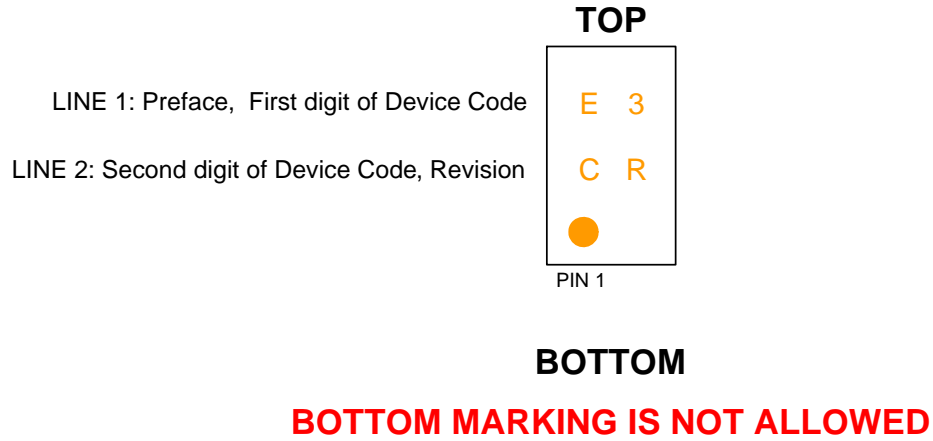

Figure 8.7 EMC1182-1 8-Pin TDFN Package Markings

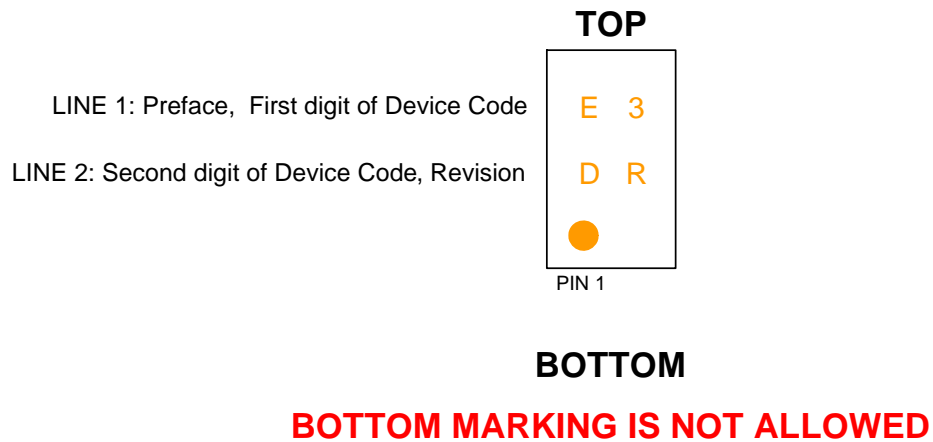

Figure 8.8 EMC1182-2 8-Pin TDFN Package Markings

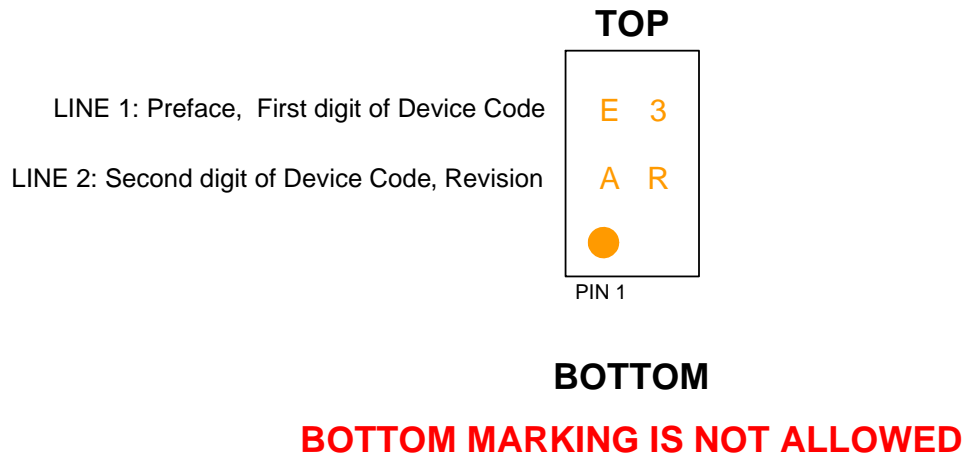

Figure 8.9 EMC1182-A 8-Pin TDFN Package Markings

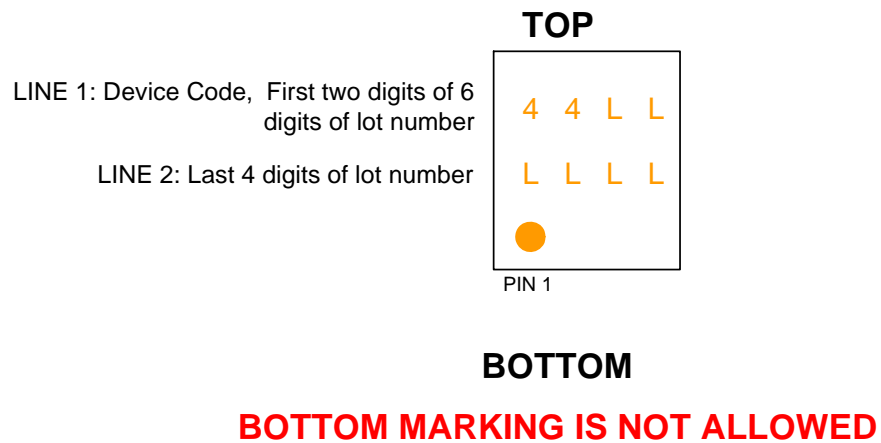

Figure 8.10 EMC1182-1 8-Pin DFN Package Markings

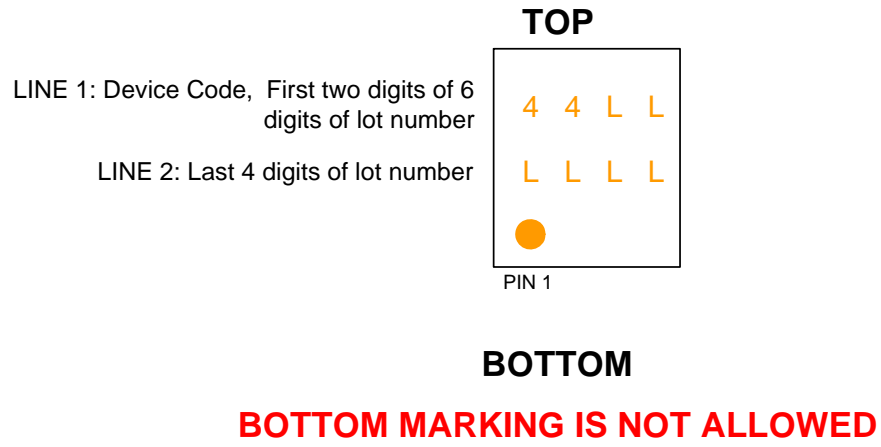

Figure 8.11 EMC1182-2 8-Pin DFN Package Markings

Chapter 9 Datasheet Revision History

Table 9.1 Customer Revision History

REVISION LEVEL & DATE	SECTION/FIGURE/ENTRY	CORRECTION
Rev. 1.0 (07-11-13)	Formal document release	

Mouser Electronics

Authorized Distributor

Click to View Pricing, Inventory, Delivery & Lifecycle Information:

Microchip:

[EMC1182-2-AC3-TR](#) [EMC1182-1-AC3](#) [EMC1182-1-AIA](#) [EMC1182-2-AC3](#) [EMC1182-1-AC3-TR](#) [EMC1182-A-AC3-TR](#) [EMC1182-2-AIA-TR](#) [EMC1182-2-AIA](#) [EMC1182-1-AIA-TR](#) [EMC1182-A-AC3](#)