

APT40SM120B

PRELIMINARY

1200V, 41A, 80mΩ

Silicon Carbide N-Channel Power MOSFET

DESCRIPTION

Silicon carbide (SiC) power MOSFET product line from Microsemi increase your performance over silicon MOSFET and silicon IGBT solutions while lowering your total cost of ownership for high-voltage applications.

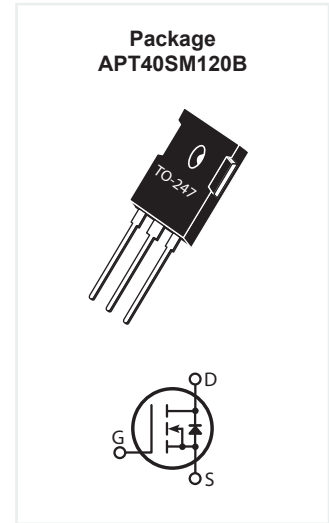

FEATURES / TYPICAL APPLICATIONS

SiC MOSFET Features:

- Low capacitances and low gate charge
- Fast switching speed due to low internal gate resistance (ESR)
- Stable operation at high junction temperature, $T_j(\text{max}) = +175\text{C}$
- Fast and reliable body diode
- Superior avalanche ruggedness

SiC MOSFET Benefits:

- High efficiency to enable lighter/compact system
- Simple to drive and easy to parallel
- Improved thermal capabilities and lower switching losses
- Eliminates the need of external Free Wheeling Diode
- Lower system cost of ownership

Applications:

- PV inverter, converter and industrial motor drives
- Smart grid transmission & distribution
- Induction heating, and welding
- H/EV powertrain and EV charger
- Power supply and distribution

MAXIMUM RATINGS

Symbol	Parameter	Ratings	Unit
V_{DSS}	Drain Source Voltage	1200	V
I_D	Continuous Drain Current @ $T_c = 25^\circ\text{C}$	41	A
	Continuous Drain Current @ $T_c = 100^\circ\text{C}$	29	
I_{DM}	Pulsed Drain Current ^①	100	
V_{GS}	Gate-Source Voltage	-10 to +25	V
P_D	Total Power Dissipation @ $T_c = 25^\circ\text{C}$	273	W
	Linear Derating Factor	1.82	W/°C

THERMAL AND MECHANICAL CHARACTERISTICS

Symbol	Characteristic	Min	Typ	Max	Unit
$R_{\theta JC}$	Junction to Case Thermal Resistance		0.36	0.55	°C/W
T_j	Operating Junction Temperature	-55		175	°C
T_{stg}	Storage Junction Temperature Range	-55		150	
T_L	Soldering Temperature for 10 Seconds (1.6mm from case)			260	
Torque	Mounting Torque (TO-247 Package), 6-32 or M3 screw			10	in·lbf
				1.1	N·m

APT40SM120B

STATIC CHARACTERISTICS

Symbol	Parameter	Test Conditions	Min	Typ	Max	Unit
$V_{(BR)DSS}$	Drain-Source Breakdown Voltage	$V_{GS} = 0V, I_D = 1mA$	1200			V
$R_{DS(on)}$	Drain-Source On Resistance ^②	$V_{GS} = 20V, I_D = 20A$		80	100	m Ω
$V_{GS(th)}$	Gate-Source Threshold Voltage	$V_{GS} = V_{DS}, I_D = 1mA$	1.7	3.0		V
$\Delta V_{GS(th)}/\Delta T_J$	Threshold Voltage Temperature Coefficient			-4.8		mV/ $^{\circ}C$
I_{DSS}	Zero Gate Voltage Drain Current	$V_{DS} = 1200V$ $V_{GS} = 0V$			100	μA
		$T_J = 25^{\circ}C$				
		$T_J = 125^{\circ}C$			500	μA
I_{GSS}	Gate-Source Leakage Current	$V_{GS} = +20V / -10V$			± 100	nA

$T_J = 25^{\circ}C$ unless otherwise specified

DYNAMIC CHARACTERISTICS

Symbol	Parameter	Test Conditions	Min	Typ	Max	Unit
C_{iss}	Input Capacitance	$V_{GS} = 0V, V_{DD} = 1000V$ $f = 1MHz$		2085		pF
C_{rss}	Reverse Transfer Capacitance			25		
C_{oss}	Output Capacitance			115		
Q_g	Total Gate Charge	$V_{GS} = 0/20V$		130		nC
Q_{gs}	Gate-Source Charge	$V_{DD} = 800V$		19		
Q_{gd}	Gate-Drain Charge	$I_D = 20A$		35		
$t_{d(on)}$	Turn-On Delay Time	$V_{DD} = 800V$ $V_{GS} = 0/20V$ $I_D = 20A$ $R_G = 0.7 \Omega$ ^③ $L = 115 \mu H$ $T_C = 25^{\circ}C$ Freewheeling Diode = APT10SCE120B		10		ns
t_r	Current Rise Time			6		
$t_{d(off)}$	Turn-Off Delay Time			32		
t_f	Current Fall Time			16		
E_{on2}	Turn-On Switching Energy ^④				225	
E_{off}	Turn-Off Switching Energy			50		
$t_{d(on)}$	Turn-On Delay Time	$V_{DD} = 800V$ $V_{GS} = 0/20V$ $I_D = 20A$ $R_G = 0.7 \Omega$ ^③ $L = 115 \mu H$ $T_C = 150^{\circ}C$ Freewheeling Diode = APT10SCE120B		8		ns
t_r	Current Rise Time			6		
$t_{d(off)}$	Turn-Off Delay Time			36		
t_f	Current Fall Time			17		
E_{on2}	Turn-On Switching Energy ^④				225	
E_{off}	Turn-Off Switching Energy			60		
ESR	Equivalent Series Resistance	$f = 1MHz, 25mV, \text{Drain Short}$		1.2		Ω
SCWT	Short Circuit Withstand Time	$V_{DS} = 960V, V_{GS} = 20V, T_C = 25^{\circ}C$		5		μs
E_{AS}	Avalanche Energy, Single Pulse	$V_{DS} = 145V, V_{GS} = 20V, I_D = 20A, T_C = 25^{\circ}C$		2500		mJ

Source-Drain Diode Characteristics

Symbol	Parameter	Test Conditions	Min	Typ	Max	Unit
V_{SD}	Diode Forward Voltage	$I_{SD} = 20A, V_{GS} = 0V$		3.8		V
t_{rr}	Reverse Recovery Time	$I_{SD} = 20A, V_{DD} = 800V$ $di/dt = -1000A/\mu s$		90		ns
Q_{rr}	Reverse Recovery Charge				265	nC
I_{rrm}	Reverse Recovery Current				7.8	A

$T_J = 25^{\circ}C$ unless otherwise specified

- ① Repetitive Rating: Pulse width and case temperature limited by maximum junction temperature
 ② Pulse test: Pulse Width < 380 μs , duty cycle < 2%.
 ③ R_G is total external gate resistance including internal gate driver impedance.
 ④ E_{on2} includes energy of APT10SCE120B free wheeling diode.

APT40SM120B

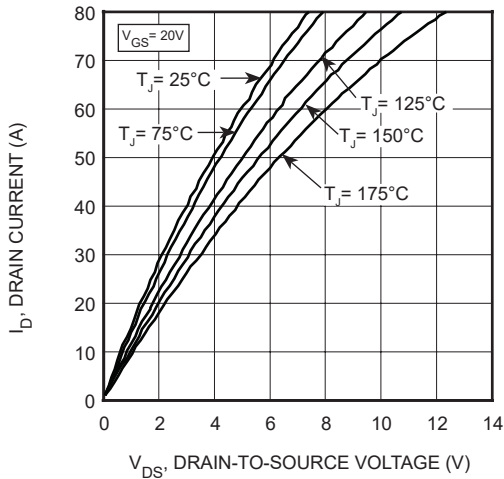

Figure 1, Output Characteristics

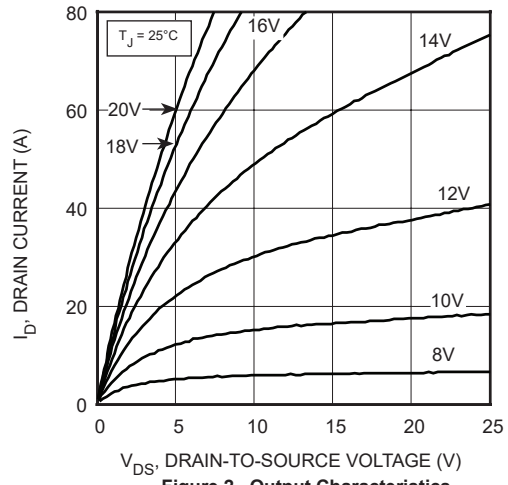

Figure 2, Output Characteristics

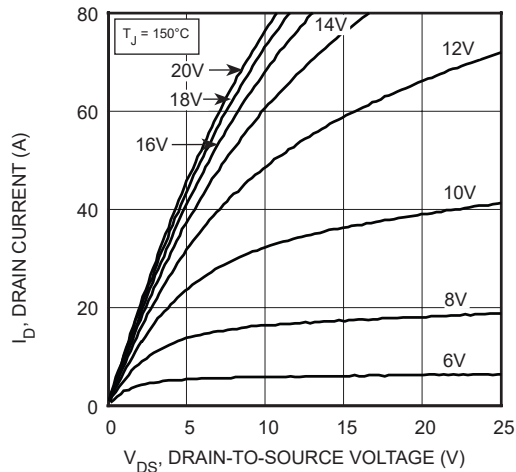

Figure 3, Output Characteristics

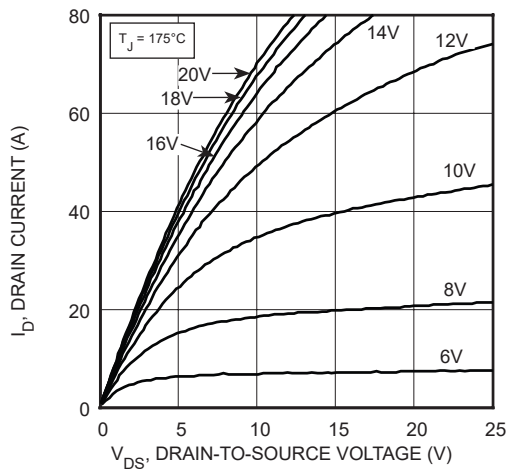

Figure 4, Output Characteristics

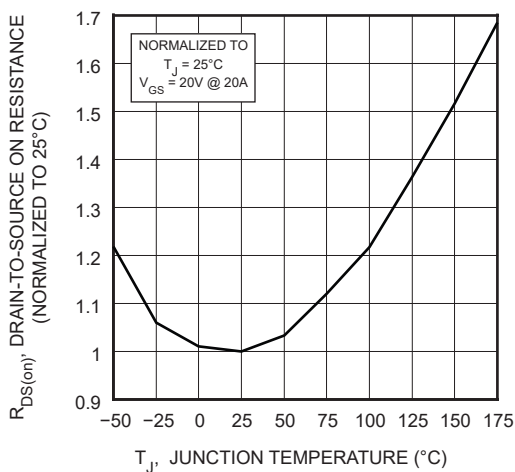

Figure 5, $R_{DS(on)}$ vs Junction Temperature

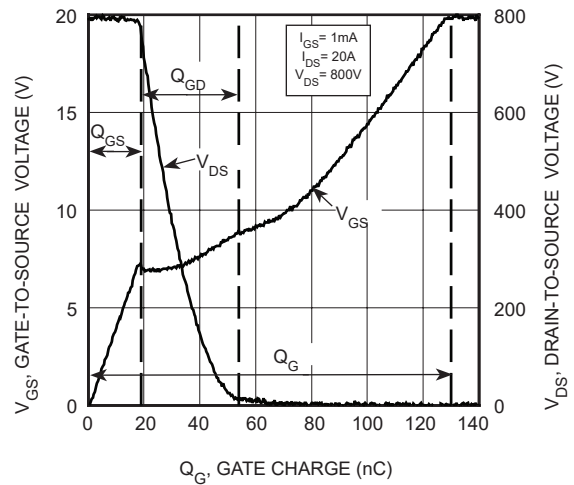

Figure 6, Gate Charge Characteristics

APT40SM120B

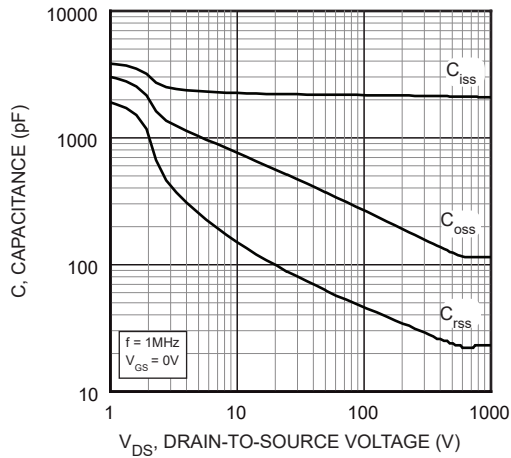

Figure 7, Capacitance vs Drain-to-Source Voltage

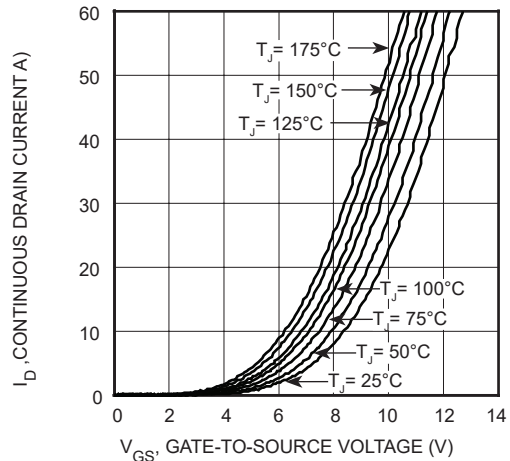

Figure 8, Output Characteristics I_D vs V_{GS} Temperature

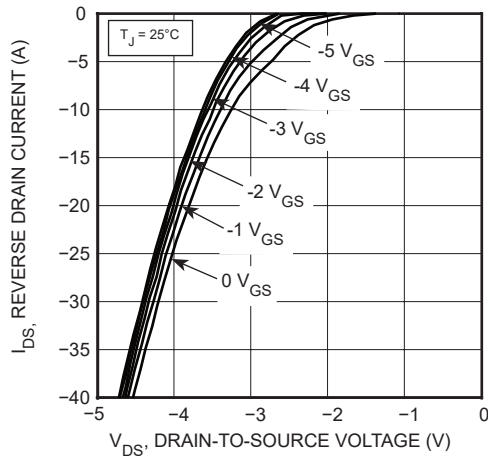

Figure 9, Reverse Drain Current vs Drain-to-Source Voltage Third Quadrant Conduction

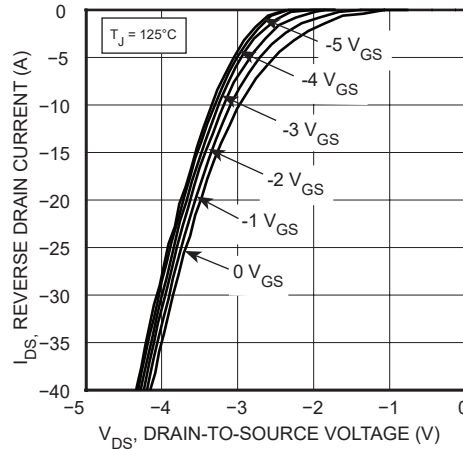

Figure 10, Reverse Drain Current vs Drain-to-Source Voltage Third Quadrant Conduction

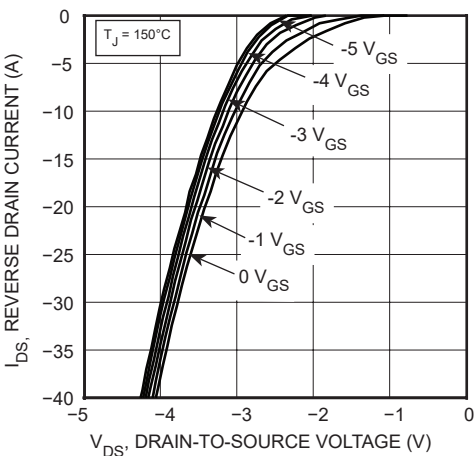

Figure 11, Reverse Drain Current vs Drain-to-Source Voltage Third Quadrant Conduction

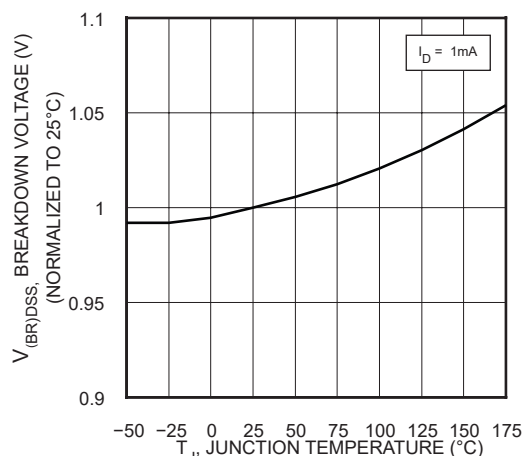

Figure 12, Breakdown Voltage vs Temperature

APT40SM120B

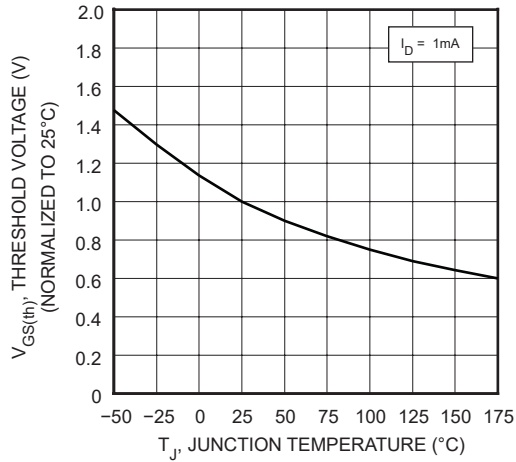

Figure 13, Threshold Voltage vs Temperature

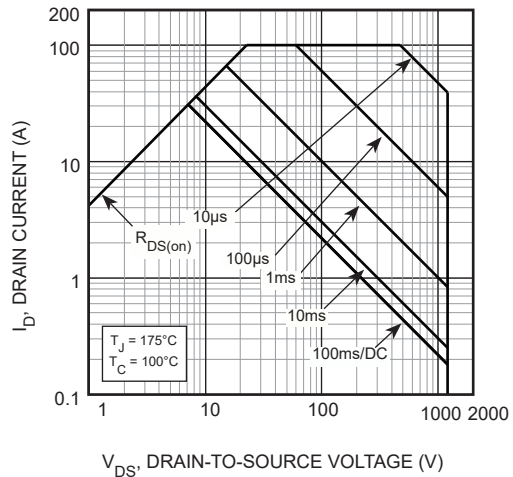

Figure 14, Forward Safe Operating Area

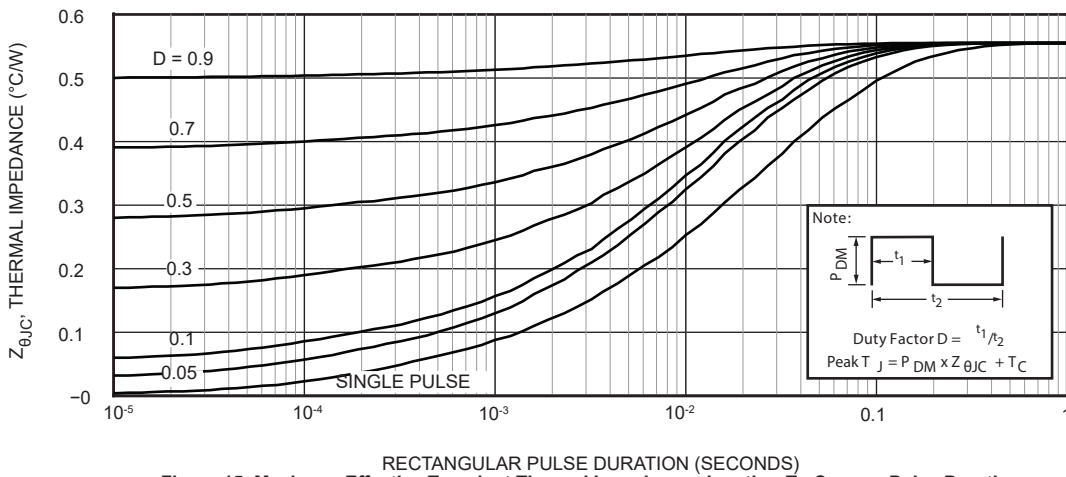
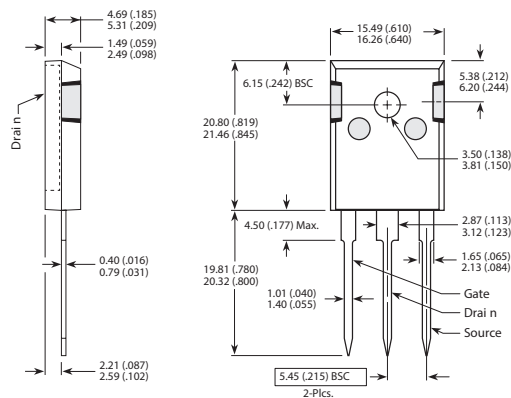

Figure 15, Maximum Effective Transient Thermal Impedance, Junction-To-Case vs Pulse Duration

TO-247 (B) Package Outline



Dimensions in Millimeters (Inches)

Microsemi makes no warranty, representation, or guarantee regarding the information contained herein or the suitability of its products and services for any particular purpose, nor does Microsemi assume any liability whatsoever arising out of the application or use of any product or circuit. The products sold hereunder and any other products sold by Microsemi have been subject to limited testing and should not be used in conjunction with mission-critical equipment or applications. Any performance specifications are believed to be reliable but are not verified, and Buyer must conduct and complete all performance and other testing of the products, alone and together with, or installed in, any end-products. Buyer shall not rely on any data and performance specifications or parameters provided by Microsemi. It is the Buyer's responsibility to independently determine suitability of any products and to test and verify the same. The information provided by Microsemi hereunder is provided "as is, where is" and with all faults, and the entire risk associated with such information is entirely with the Buyer. Microsemi does not grant, explicitly or implicitly, to any party any patent rights, licenses, or any other IP rights, whether with regard to such information itself or anything described by such information. Information provided in this document is proprietary to Microsemi, and Microsemi reserves the right to make any changes to the information in this document or to any products and services at any time without notice.



Microsemi Corporate Headquarters
One Enterprise, Aliso Viejo, CA 92656 USA
Within the USA: +1 (800) 713-4113
Outside the USA: +1 (949) 380-6100
Sales: +1 (949) 380-6136
Fax: +1 (949) 215-4996
email: sales.support@microsemi.com
www.microsemi.com

Microsemi Corporation (Nasdaq: MSCC) offers a comprehensive portfolio of semiconductor and system solutions for communications, defense & security, aerospace and industrial markets. Products include high-performance and radiation-hardened analog mixed-signal integrated circuits, FPGAs, SoCs and ASICs; power management products; timing and synchronization devices and precise time solutions, setting the world's standard for time; voice processing devices; RF solutions; discrete components; security technologies and scalable anti-tamper products; Ethernet Solutions; Power-over-Ethernet ICs and midspans; as well as custom design capabilities and services. Microsemi is headquartered in Aliso Viejo, Calif., and has approximately 4,800 employees globally. Learn more at www.microsemi.com.

©2016 Microsemi Corporation. All rights reserved. Microsemi and the Microsemi logo are registered trademarks of Microsemi Corporation. All other trademarks and service marks are the property of their respective owners.

Mouser Electronics

Authorized Distributor

Click to View Pricing, Inventory, Delivery & Lifecycle Information:

[Microchip:](#)

[APT40SM120B](#)