

LS03 Series Level Sensors

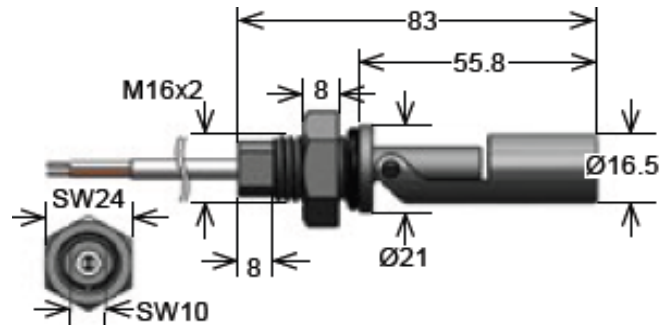

- Features: Single Level Horizontal Mount, High Power Switch Option, Other Cables & Connectors
- Applications: Level Control, Detection and Monitoring
- Markets: Automotive, Appliance, HVAC/R, Test & Measurement

Part-Description: **LS-03 0X00-XX-000X**

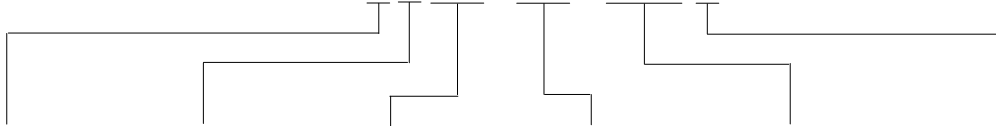

Contact QTY	Contact Form	Switch Model	Material	Cable Length (mm)	Cable Termination
01	A (SPST-NO) B (SPST-NC)	66, 85	PA, PP	500	W = Stripped and Tinned

Customer Options	Switch Model		Unit
	66	85	
Contact Data			
Rated Power (max.) <small>Any DC combination of V&A not to exceed their individual max.'s</small>	10	100	W
Switching Voltage (max.) <small>DC or peak AC</small>	200	400	V
Switching Current (max.) <small>DC or peak AC</small>	0.5	1.0	A
Carry Current (max.) <small>DC or peak AC</small>	1.25	2.5	A
Contact Resistance (max.) <small>@ 0.5V & 10mA</small>	150	150	mOhm

Glossary Contact Form		
Form A	NO = Normally Open Contacts SPST = Single Pole Single Throw	
Form B	NC = Normally Closed Contacts SPST = Single Pole Single Throw	
Form C	Changeover SPDT = Single Pole Double Throw	

Glossary Material	
PP: Polypropylene	For water applications and dilute acids
PA: Polyamide	For oil
NBR: Nitrile Butadiene Rubber	For oil, gasoline & in high temperatures
SS: Stainless Steel	For high temp. (< 160° C)

General Sensor Data		
Materials		
Stem, Nut	PA	PP
Float	PA	PP
Seal	Nitrile Rubber	Nitrile Rubber
Cable spec	Low voltage (Switch Model 66)	High voltage (Switch Model 66)
Cross Section (mm ²)	0.14	0.25
Cable material	PVC	
Packing	Bulk	

Environmental Data		Unit
Shock Resistance (max.) 1/2 sine wave duration 11ms	50	G
Vibration Resistance (max.)	20	G
Operating Temperature Cable not moved	-20 to 80	°C
Operating Temperature Cable moved	-5 to 80	°C
Storage Temperature	-30 to 70	°C

Handling & Assembly Instructions	
Standard	GZ-Type
<ul style="list-style-type: none"> ➤ Mounting from inside, thread M16 x 2.0 ➤ Insertion hole: Ø 16.5mm ➤ Sealing from inside, with O-ring 	<ul style="list-style-type: none"> ➤ Mounting from outside, tapered thread ½" (no sealing necessary) ➤ Insertion hole: 1/2" thread
DK-Type	DL-Type
<ul style="list-style-type: none"> ➤ Mounting from outside, thread M16 x 2.0 ➤ Insertion hole: Ø 22mm ➤ 5mm narrow sealing, suitable for high filling Pressure ➤ Wall thickness min. 4mm 	<ul style="list-style-type: none"> ➤ Mounting from outside, thread M16 x 2.0 ➤ Insertion hole: Ø 22–24 mm ➤ 12mm wide sealing, suitable for low filling Pressure ➤ Wall thickness max. 5mm

LS03 Versions

Standard-Version

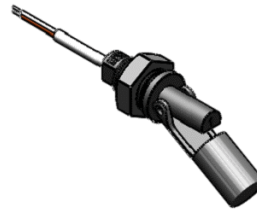

GZ-Version

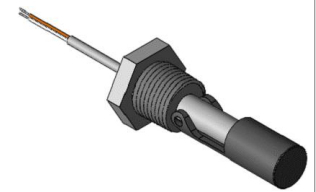

DK-Version

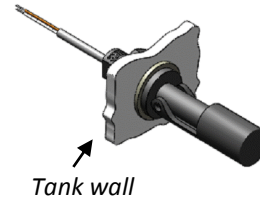

DL-Version

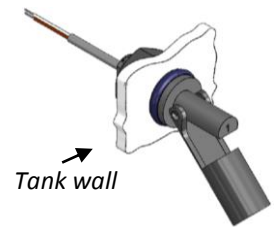

LS03 Level Sensor



Life Test Data

*Load increase reduces life expectancy of Reed Switches

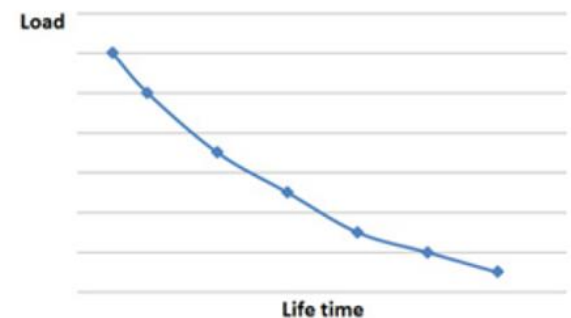

Mouser Electronics

Authorized Distributor

Click to View Pricing, Inventory, Delivery & Lifecycle Information:

[Standex Electronics:](#)

[LS03/DL-1A52-PP-500W](#) [LS03/DL-1A66-PA-500W](#) [LS03/DL-1A85-PA-500W](#)