



■ Features :

- True sine wave output (THD<3%)
- High surge power up to 6000W
- U.P.S. mode and energy saving mode (selectable)
- High efficiency up to 92%
- Power ON-OFF switch
- Standby saving mode can be selectable
- Front panel indicator for operation status
- Thermostatically controlled cooling fan
- Protections: Bat. low alarm / Bat. low shutdown / Over voltage / Over temp. / Output short / Input polarity reverse / Overload / AC circuit breaker
- Application : Home appliance, power tools, office and portable equipment, vehicle and yacht ...etc.
- Built-in solar / AC charger
- Optional monitoring software and connection cable (MW order No.: DS-TN-1500)
- 3 years warranty



SPECIFICATION

MODEL	TN-3000-112	TN-3000-124	TN-3000-148	TN-3000-212	TN-3000-224	TN-3000-248	
OUTPUT	RATED POWER (Typ.)	3000W					
	MAXIMUM OUTPUT POWER (Typ.)	3450W for 180 sec. / 4500W for 10 sec. / surge power 6000W for 30 cycles					
	AC VOLTAGE	Factory setting set at 110VAC 100 / 110 / 115 / 120VAC selectable by setting button S.W			Factory setting set at 230VAC 200 / 220 / 230 / 240VAC selectable by setting button S.W		
	FREQUENCY	60±0.1Hz 50/60Hz selectable by setting button S.W			50±0.1Hz 50/60Hz selectable by setting button S.W		
	WAVEFORM	True sine wave (THD<3%) at rated input voltage					
	AC REGULATION (Typ.)	±3%					
	TRANSFER TIME (Typ.)	10ms inverter → by pass					
	SAVING MODE (Typ.)	Default disabled. Load ≤ 5W will be changed to standby mode					
FRONT PANEL INDICATOR	Battery voltage level, output load level, saving mode, fault and operation status						
INPUT	BAT. VOLTAGE	12V	24V	48V	12V	24V	48V
	VOLTAGE RANGE (Typ.) Note.3,6	10.5 ~ 15VDC	21 ~ 30VDC	42 ~ 60VDC	10.5 ~ 15VDC	21 ~ 30VDC	42 ~ 60VDC
	DC CURRENT (Typ.) Note.4	300A	150A	75A	300A	150A	75A
	NO LOAD DISSIPATION (Typ.)	≤ 10W @ standby saving mode					
	OFF MODE CURRENT DRAW (Typ.)	≤ 1mA					
	EFFICIENCY (Typ.) Note.1	88%	90%	91%	89%	91%	92%
	BATTERY TYPES	Open & sealed lead acid battery					
BATTERY INPUT PROTECTION	FUSE	40A*12	40A*6	20A*6	40A*12	40A*6	20A*6
	BAT. LOW ALARM Note.6	11.3V	22.5V	45V	11.3V	22.5V	45V
	BAT. LOW SHUTDOWN Note.6	10.5V	21V	42V	10.5V	21V	42V
	REVERSE POLARITY	By internal fuse open					
OUTPUT PROTECTION	OVER TEMPERATURE	90°C ± 5°C	85°C ± 5°C	85°C ± 5°C	80°C ± 5°C	75°C ± 5°C	75°C ± 5°C
	OUTPUT SHORT	Protection type : Shut down o/p voltage, re-power on to recover					
	OVER LOAD (Typ.)	105 ~ 115% load for 180 sec., 115% ~ 150% load for 10 sec. Protection type : Shut down o/p voltage, re-power on to recover					
	CIRCUIT BREAKER	AC output: 40A, AC receptacle: 15A			AC output: 20A, AC receptacle: 15A		
	GFCI PROTECTION	Optional (Only type F)			None		
ENVIRONMENT	WORKING TEMP. Note.2	0 ~ +40°C @ 100% load ; 60°C @ 50% load					
	WORKING HUMIDITY	20% ~ 90% RH non-condensing					
	STORAGE TEMP., HUMIDITY	-30 ~ +70°C / -22 ~ +158°F, 10 ~ 95% RH					
	VIBRATION	10 ~ 500Hz, 3G 10min./1cycle, 60min. each along X, Y, Z axes					
SAFETY & EMC	SAFETY STANDARDS	UL458 (only for Type G)		None			
	LVD	None			EN60950-1		
	WITHSTAND VOLTAGE	Bat I/P - AC I/P: 3.0KVAC Bat I/P - AC O/P: 3.0KVAC AC O/P - FG: 1.5KVAC					
	ISOLATION RESISTANCE	Bat I/P - AC O/P, Bat I/P - FG, AC O/P - FG: 100M ohms / 500VDC / 25°C / 70% RH					
	EMC EMISSION	Compliance to FCC class A			Compliance to EN55022 class A, 72/ 245/ CEE, 95/ 54/ CE, E-Mark		
	EMC IMMUNITY	None			Compliance to EN61000-4-2,3,4,5,6,8,11		
AC CHARGER	CHARGE CURRENT (Typ.)	25A	12A	6A	25A	12A	6A
	CHARGE VOLTAGE Note.6	14.3V	28.5V	57V	14.3V	28.5V	57V
SOLAR PANEL	MAX OPEN CIRCUIT VOLTAGE	25V	45V	75V	25V	45V	75V
	SHORT CIRCUIT CURRENT (max.)	30A					
OTHERS	CONTROL WIRING	RJ11 -RS232 (Option)					
	DIMENSION	466.8*283.5*100mm (L*W*H)					
	PACKING	12.9Kg; 1pcs/14Kg/1.98CUFT					
NOTE	<p>1. Efficiency is tested by 2100W, linear load at 13V, 26V, 52V input voltage. 2. Output derating capacity referenced by curve 1. 3. Input derating capacity referenced by curve 2. 4. DC current is tested by 3000W, linear load at 12V, 24V, 48V input voltage. 5. All parameters not specified above are measured at rated load, 25°C of ambient temperature. 6. The tolerance of each voltage value by models is: 112/212 → ±0.5V; 124/224 → ±1V; 148/248 → ±2V</p>						

Instructions for TN-3000 monitoring software

1. Installation of TN-3000 unit and PC

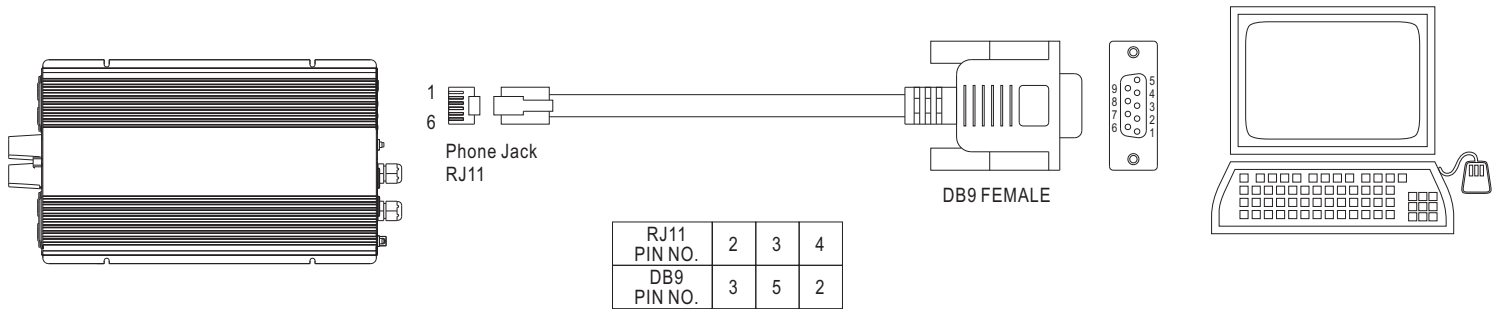

Figure 1

2. Explanation of Monitoring Manu

2.1 Main Page

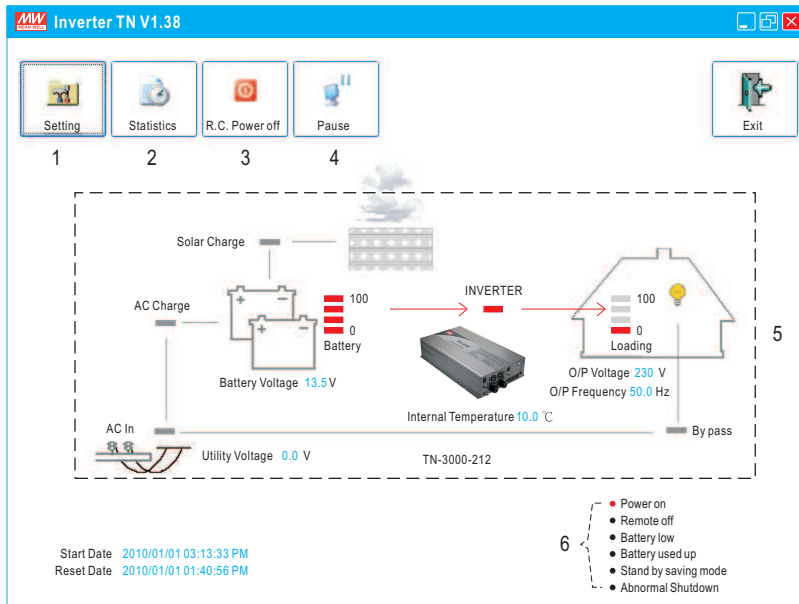

Figure 2

1. Setting: Adjustment for output voltage, charging related voltage, frequency, and operation mode. Please refer to Figure 3 for details.
2. Statistics: Calculate for the percentage of operating period for each operation mode. Please refer to Figure 4 for details.
3. R.C. Power off: Power can be turned ON or OFF at the remote location.
4. Pause: Stop refreshing the page of monitoring software.
5. Status of unit: Indicating current operating status of TN-3000.
6. Signals that display current condition of the unit.

2.2 Setting Page

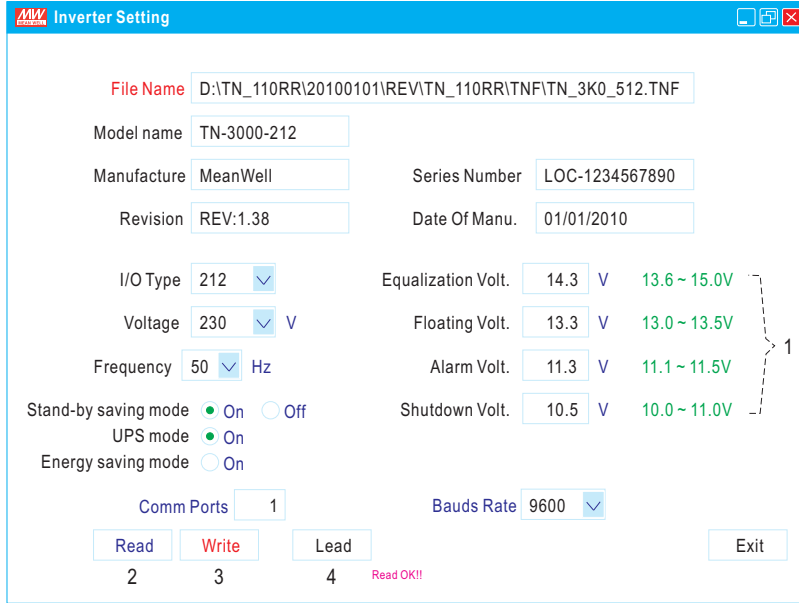

Figure 3

1. User can adjust the settings based on the characteristics of batteries been used: Equalization Voltage, Floating Voltage, Alarm Voltage, and Shut-down Voltage. UPS Mode / Energy Saving Mode selection and AC output voltage and frequency can also be set in this page.
2. Read: Read current settings of the unit.
3. Write: Write the revised setting into the unit.
4. Load: Load in factory default settings.

2.3 Statistic Page

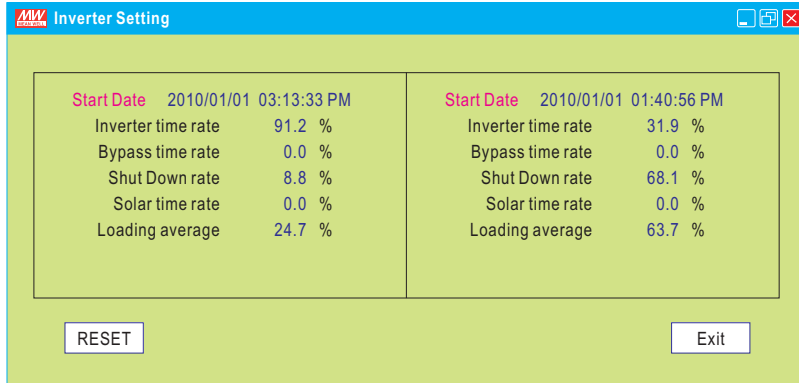

Figure 4

1. Start Date: Date that installing the monitoring software.
2. Reset Date: Date that resetting the statistics. The Start Date will not be influenced by resetting the statistics or turning off the unit.
3. Inverter time rate: Operating period of "Inverter Mode" represents how many percent of the whole operating period.
4. Bypass time rate: Operating period of "Bypass Mode" (energy provides directly by the utility) represents how many percent of the whole operating period.
5. Shut down rate: Percentage of time period that the unit is under the condition of shut down.
 * **Inverter time rate + Bypass time rate + Shut down rate = 100%**
6. Solar time rate: Percentage of time period that the solar charger is functioning after turning on the TN-3000 unit.
7. Loading average: Average loading after turning on the TN-3000 unit.

True sine wave inverter
+AC charger and solar charger

O/P Wattage: 3000W

TN - 3000 - 112 A

Bat. Voltage: 12:12VDC
24:24VDC
48:48VDC

Output: 1:110VAC
2:230VAC

A : TYPE A OUTLET
B : TYPE B OUTLET
C : TYPE C OUTLET
D : TYPE D OUTLET
E : TYPE E OUTLET
F : TYPE F OUTLET
G : TYPE G TERMINAL

AC Output Receptacle (optional)

Receptacle type	TYPE-A	TYPE-B	TYPE-C	TYPE-D	TYPE-E	TYPE-F	TYPE-G
Country	USA	EUROPE	AUSTRALIA	U.K	JAPAN	GFCI	----
Certificate	FC	E13 CE	E13 CE	E13 CE	FC	FC	UL US (Expect for 48V input) FC

Mechanical Specification

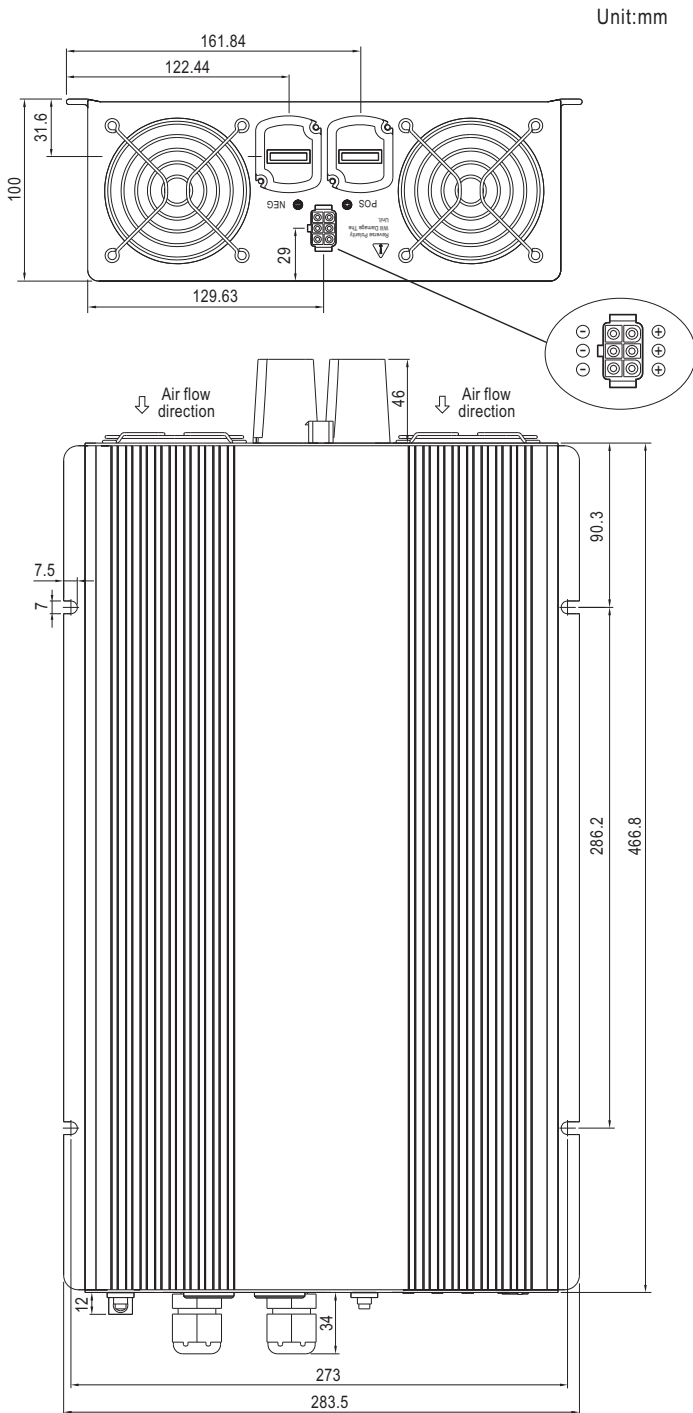

Derating Curve

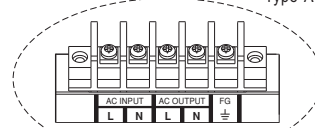
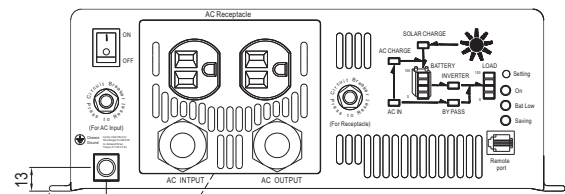
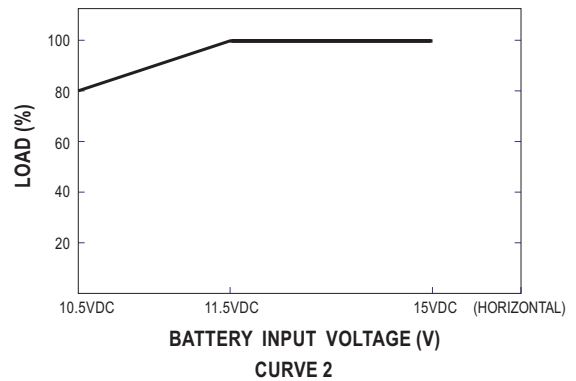
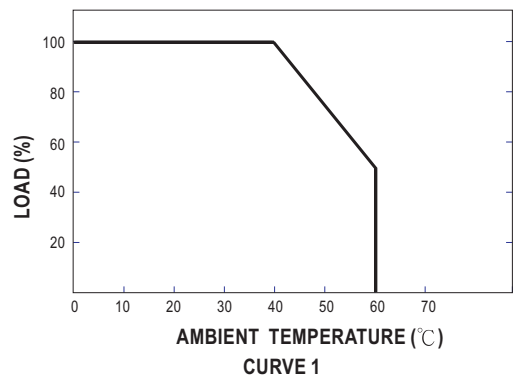

Note: When the load current is >15A, must use output terminal connection which can be found inside the AC output panel of the inverter.

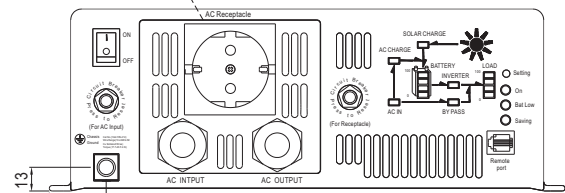

Mouser Electronics

Authorized Distributor

Click to View Pricing, Inventory, Delivery & Lifecycle Information:

[Mean Well:](#)

[TN-3000-224B](#)