

DPS9 SERIES PUSHWHEEL SWITCHES

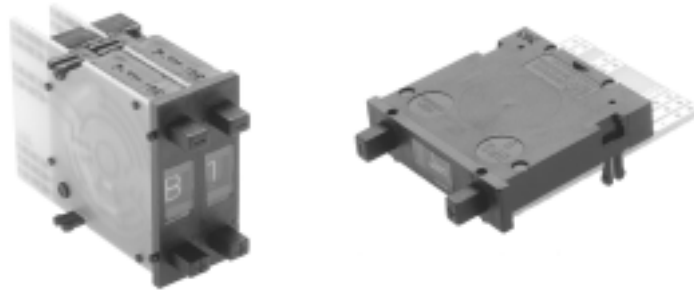

FEATURES

- **.315" (8mm) wide pushwheel switches with extra large visible readout characters .**
- **Bi-directional snap action detent pushbutton mechanism.**
- **Black housing and drum with white printing.**
- **Gangable front mounting models with spacers and side covers.**
- **Gold wiping action contacts.**
- **P.C. board options include solderable lands.**

DPS9 SPECIFICATIONS

Panel mounting hole:	
Height	1.300"(33mm)
Width	.315"(8mm)
Installed depth with p.c. board:	
Short	1.535"(39mm)
Long	1.968"(50mm)
Insertion from front	yes
Insertion from rear	no

CODES

Code	positions	marking	
111 Decimal	10	0-9	see truth tables
131 BCD	10	0-9	see truth tables
137 BCD comp	10	0-9	see truth tables
141 BCD + comp	10	0-9	see truth tables
301 Hexadecimal	16	0-9, A-F(0-15)	see truth tables
307 Hexadec comp	16	0-9, A-F(0-15)	see truth tables
400 change-over	10	+,-,+,-,etc..	see truth tables

ELECTRICAL DATA

Operating voltage:	40 V max.
Contact load, static:	1 A max.
Contact load, dynamic:	100 mA max.
Contact resistance (type AK):	less than 100 mOhm

TECHNICAL DATA

Operating temperature range:	-20°C to 80°C
Electric life, min. switching cycles	greater than 1,000,000
Actuation force, approx (oz.):	16
Weight, approx. (grams):	6.5
Character ht: 10 digit - .268" (6.8mm)	16 digit - .169" (4.3mm)
Audible click	yes
Vibration DIN IEC 68, parts 2-6	yes
Shock DIN 40046, part 7	yes

MATERIALS

Body:	PPO
PC board:	FR 4 DIN 40802 IEC 249-2, Contact surface gold over nickel on copper
Sliding contact:	Gold over nickel on copper alloy

STANDARD COLORS

Housing, Drum, Printing	
2 = black 3 = white	2,2,3

Other special features are available upon request including:

- Factory or customer set stops (10 digit models)
- L.E.D. illumination (transparent drum)
- Red digits
- Decimal point
- Special codes or printing
- Gray housing
- See sockets at end of Pushwheel section.

SPECIFICATIONS SUBJECT TO CHANGE WITHOUT NOTICE

T

DPS9 SERIES PUSHWHEEL SWITCHES

TRUTH TABLES

CODE 131 BCD					
	C	1	2	4	8
0	●				
1	●	●			
2	●		●		
3	●	●	●		
4	●			●	
5	●	●		●	
6	●	●	●	●	
7	●	●	●	●	
8	●				●
9	●	●			●

CODE 137 BCD COMP.					
	C	$\bar{1}$	$\bar{2}$	$\bar{4}$	$\bar{8}$
0	●	●	●	●	●
1	●		●	●	●
2	●	●		●	●
3	●		●	●	●
4	●	●	●		●
5	●		●		●
6	●	●			●
7	●				●
8	●	●	●	●	
9	●	●	●	●	

CODE 400 CHANGE-OVER			
	C	A+	A-
+	●	●	
-	●		●
+	●	●	
-	●		●
+	●	●	
-	●		●
+	●	●	
-	●		●
+	●	●	
-	●		●

CODE 301 HEXADECIMAL					
	1	2	4	8	C
0					●
1	●				●
2		●			●
3	●	●			●
4			●		●
5	●	●	●		●
6		●	●		●
7	●	●	●		●
8				●	●
9	●			●	●
A		●	●	●	●
B	●	●	●	●	●
C			●	●	●
D	●		●	●	●
E		●	●	●	●
F	●	●	●	●	●

CODE 307 HEXADEC. COMP.					
	C	$\bar{1}$	$\bar{2}$	$\bar{4}$	$\bar{8}$
0	●	●	●	●	●
1	●		●	●	●
2	●	●		●	●
3	●		●	●	●
4	●	●	●		●
5	●		●		●
6	●	●			●
7	●				●
8	●	●	●	●	
9	●	●	●	●	
A	●	●		●	
B	●		●		
C	●	●	●		
D	●		●		
E	●	●			
F	●				

CODE 111 DECIMAL											
	C	0	1	2	3	4	5	6	7	8	9
0	●	●									
1	●		●								
2	●			●							
3	●				●						
4	●					●					
5	●						●				
6	●							●			
7	●								●		
8	●									●	
9	●										●

CODE 141 BCD + COMP.									
	C	1	2	4	8	$\bar{1}$	$\bar{2}$	$\bar{4}$	$\bar{8}$
0	●					●	●	●	●
1	●	●					●	●	●
2	●		●			●		●	●
3	●	●	●				●	●	●
4	●			●		●	●		●
5	●	●	●				●		●
6	●		●	●		●			●
7	●	●	●	●			●		●
8	●				●	●	●	●	
9	●	●			●	●	●	●	

MECHANICAL OUTLINE WITH PANEL CUT-OUT & MOUNTING

n = number of decades

Dimensions in brackets apply when **DPS910PB2** side covers are used.

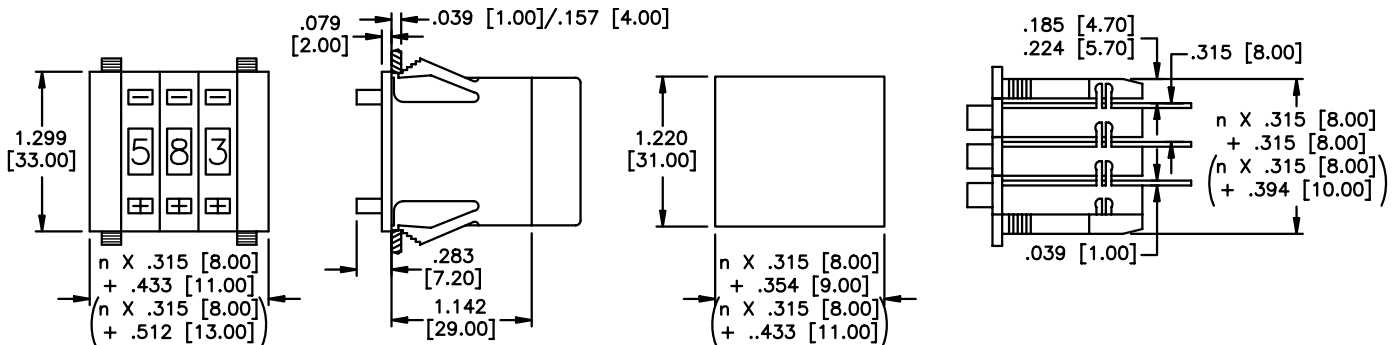

PIN CONNECTIONS



● The switching mode is shorting - i.e. - even during actuation, at least one output is connected to input C.

AK ●

●	131	+	1	2			C	8	4	-
	137	+	$\bar{1}$	$\bar{2}$			C	$\bar{8}$	$\bar{4}$	-
	141	+		2	$\bar{4}$	$\bar{2}$	C	$\bar{8}$	1	8
●	301	+	1	2			C	8	4	-
●	307	+	$\bar{1}$	$\bar{2}$			C	$\bar{8}$	$\bar{4}$	-
	400	+	C				A-	A+		-
	111		0	1	2	3	C	4	5	6
			7	8	9					

111bl + C 0 1 2 3 4 5 6 7 8 9 - Pitch .079" (2mm)

SPECIFICATIONS SUBJECT TO CHANGE WITHOUT NOTICE

DPS9 SERIES PUSHWHEEL SWITCHES

PRINTED CIRCUIT OPTIONS

P.C. boards have .039" (1mm) holes and are suitable for soldering or socket connection (with the exception of LED illumination option).

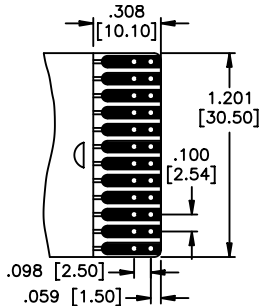

AK short p.c. board

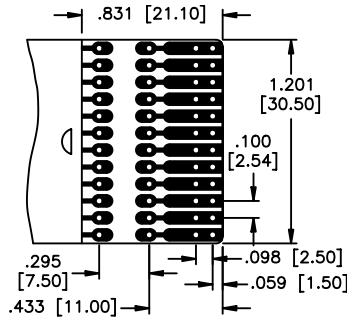

AL long p.c. board
Allows customer to add resistors, diodes, ect.

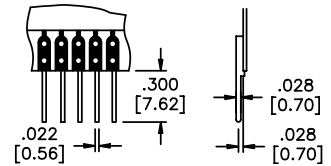

LS p.c. board w/solder pins

Ordering information: Below is an order format that enables you to 'build your own switch' and specify the correct switch model number by simply selecting from available options shown and filling in the boxes. Consult factory for fully assembled switches.

'BUILD YOUR OWN SWITCH' ORDER FORMAT

Series model	Code	P.C. board	Terminations	Standard colors
D P S 9	<input type="text"/>	<input type="text"/>	<input type="text"/>	<input type="text"/>
	1 1 1 Decimal 1 3 1 BCD 1 3 7 BCD comp. 1 4 1 BCD + comp. 3 0 1 Hexadecimal. 3 0 7 Hexadecimal comp. 4 0 0 Change-over	A K Short A L Long	(NONE) L S with p.c. solder pins	2 Black housing & drum, white lettering.

Example of complete model no.: **DPS9141AKLS2**
Order SP15 as a separate line item for limit stop pin (for 10 position models only).

ACCESSORIES

Order separately

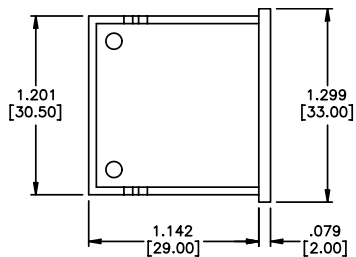

DPS9L2 Dummy housing

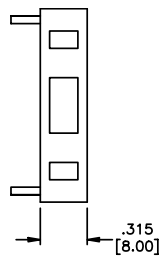

DPS910P2 Pair of side covers

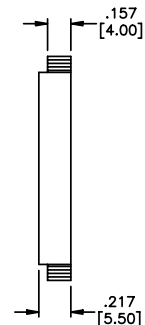
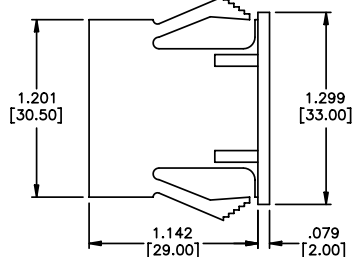

DPS9L2 Dummy switches

These are empty plastic housings with the same dimensions as DPS9 model (see outline). Use to fill hole where switch is not needed.

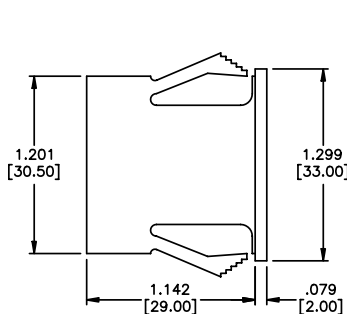

DPS910PB2 Pair of side covers

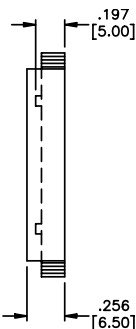

DPS910A2 Spacer

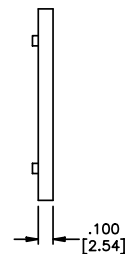
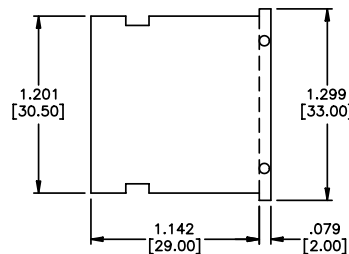

Mouser Electronics

Authorized Distributor

Click to View Pricing, Inventory, Delivery & Lifecycle Information:

[Apem:](#)

[DPS9111AKLS2](#) [DPS9111ALLS2](#) [DPS9131AKLS2](#) [DPS9131ALLS2](#) [DPS9137AKLS2](#) [DPS9137ALLS2](#)
[DPS9141AKLS2](#) [DPS9141AL2](#) [DPS9141ALLS2](#) [DPS9301AKLS2](#) [DPS9301ALLS2](#) [DPS9307AKLS2](#) [DPS9400AK2](#)
[DPS9400AKLS2](#) [DPS9400ALLS2](#)