

# 10C

Round caps • ergonomic feel



## DISTINCTIVE FEATURES

Slightly concave round cap

Ø19.2 mm

h=13.7 mm

Consists of two pieces

Designed for excellent illumination

SWITCH SPECIFICATIONS : see Multimec® 5 series.

### 5G+10C - SMD

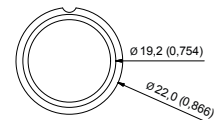
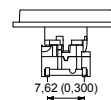
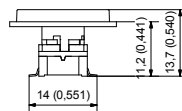

### 5G+10C - TH W/LED

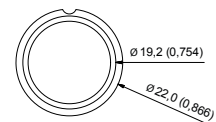
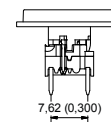
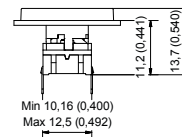

# 10C

Round caps • ergonomic feel



## MOUNTING

- Panel cut-out :  
10C :  $\varnothing 19.8$  mm
- Switch spacing AxB :  
10C : illuminated 30.2 x 30.2 mm  
non-illuminated 24 x 24 mm



## ASSEMBLY

1.

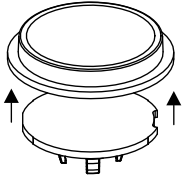

2.

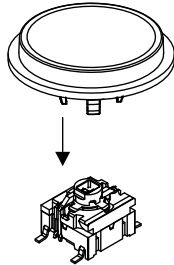

## MATERIALS

- Top part of the cap : :  
- solid color : ABS UL94HB  
- illuminated : polycarbonate UL94HB
- Bottom part of the cap : polycarbonate UL94HB



## LED PLACEMENT

SMD

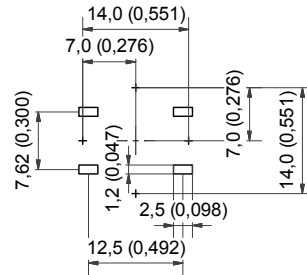

TH

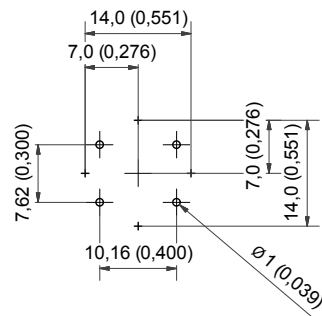

Round caps • ergonomic feel



## BUILD YOUR PART NUMBER

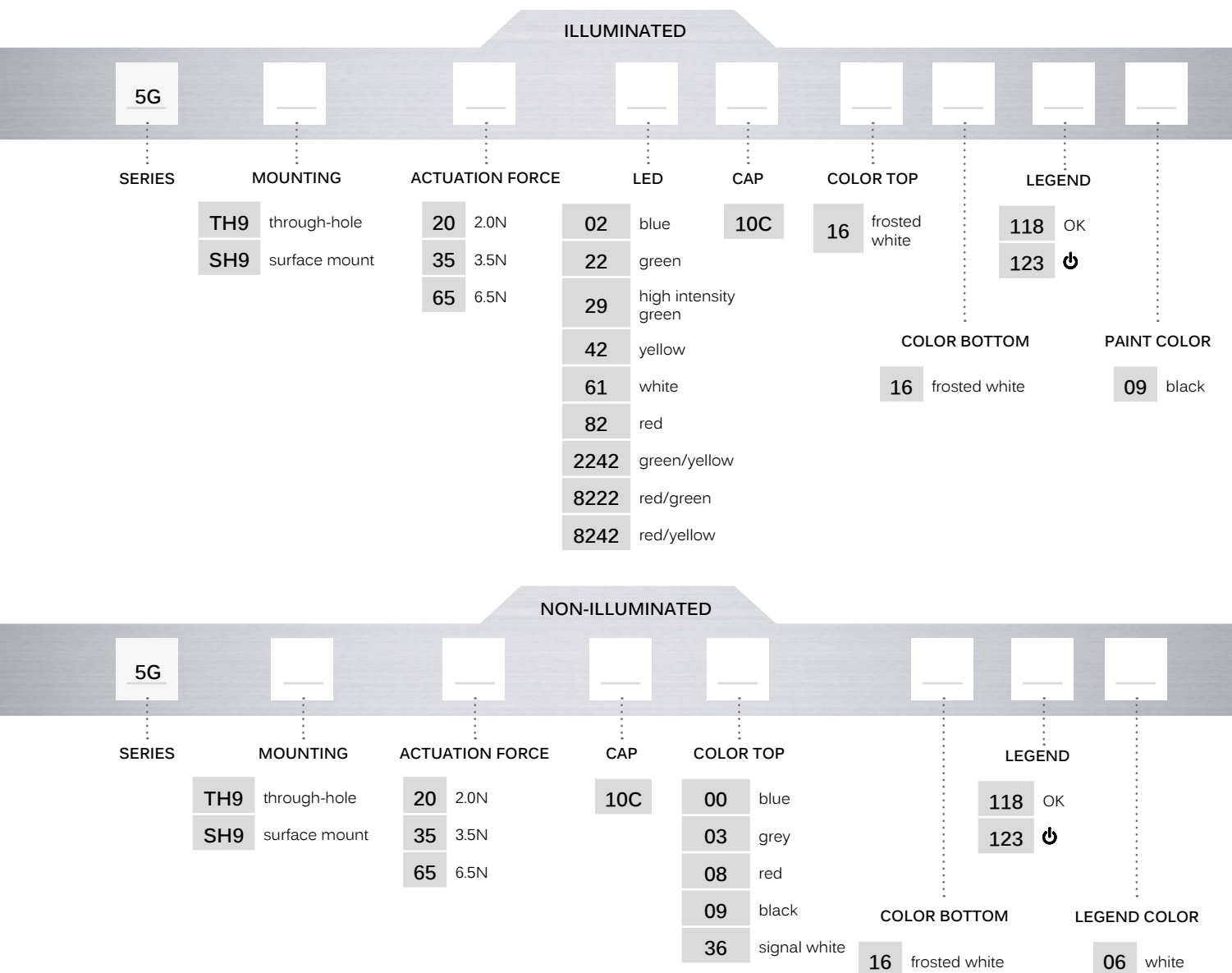

## ABOUT THIS SERIES

⚠ **Notice** : please note that not all combinations of above numbers are available. Contact factory for more information.

For more information on legends see the next two pages.

# Legends

Available for Multimec caps



## STANDARD LEGENDS

STANDARD LEGENDS									
LEGEND	1DS09_	1FS096R_	1ZB09D_ 1ZB16DLMH_	1ZCS_	1Z_ 1ZW_	10R_ & 10RF_ 10RM16_	10Q_ 10QM16_	10A_	10C_
0	000	000							
1	001	001							
2	002	002							
3	003	003							
4	004	004							
5	005	005							
6	006	006							
7	007	007							
8	008	008							
9	009	009							
#	107	107							
*	019	019							
←	033								
→	133								
↑	034								
↓	134								
↙	135	135							
+						054	054	054	
-						059	059	059	
▲			136		136			136	
⏻	123	123		123*	123	123	123		123
ON/OFF						017	017		
STOP						018	018		
START						031	031		
RESET				038		038	038		
CANCEL						048	048		
ENTER						105	105		
ESC				051					
ON								116	
OFF								117	
OK				118*	118	118	118		118
SET				119					
MENU				120					
FUNC				121					
HOME				122					

### STANDARD OPTIONS

- 1DS: pad printed
- 1FS: reverse printed
- 1ZB: pad printed / laser marked
- 1ZCS: pad printed \*reverse printed \*laser marked
- 1Z & 1ZW: pad printed / laser marked
- 10RM & 10QM: metal symbol
- 10R(F) & 10Q: pad printed / reverse printed
- 10A: pad printed / laser marked
- 10C: pad printed / laser marked



## HOW TO ORDER

### POSITIONING OF LEGENDS ON ROCKER-ACTION CAPS

When ordering legends for caps with hinge-type cap retention system, it is important to note the position of the cap. An extra letter (U, D, R or L) needs to be added to the part number to refer to the position of the hinges in relation to the legend. See samples:

Rocker-action caps without a lens: 1A, 1B, 1M, 1ZA and 1ZB

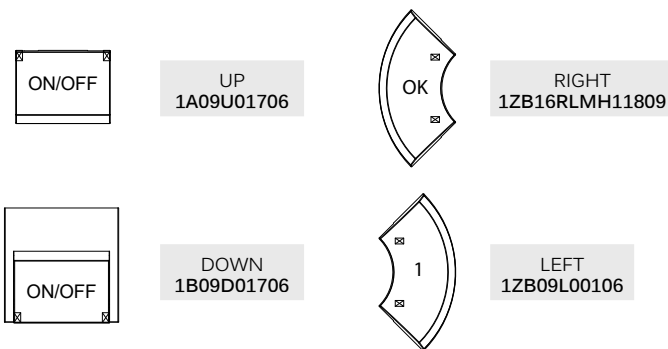

### LEGEND ILLUMINATION

- **Option 1 - laser marked:** In case of laser marked legends an "LM" is added after the cap colour, before the legend code. We recommend using hard paint (additional "H" ) for increased lifetime of the paint. E.g. 1ZB16DLMH13609
- **Option 2 - reverse printed:** In case of reverse printed caps an "R" is added after the cap colour, before the legend code. Especially relevant when standard legends have both negative and positive print options. E.g. 1FS096R00009
- **Option 3 - metal symbol:** Only available for 10RM and 10QM (therefore the "M"). E.g. 10RM16059

### ORIENTATION OF THE SWITCH

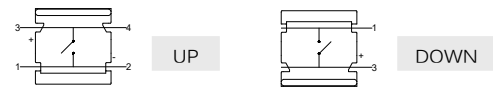

### STANDARD AND CUSTOM LEGENDS

- Standard are only certain legends on certain caps. See the table on the previous page.
- All standard pad-printed legends are white on black caps.
- All standard reverse-printed and laser marked legends are black on frosted white cap.

### STANDARD LEGENDS

CAP	CAP COLOR	DIRECTION*	TYPE*	LEGEND	LEGEND COLOR*
1B	00 Blue	D Down	LM Laser marked on soft paint	001 1	00 Blue
1DS	02 Green	U Up	LMH Laser marked on hard paint	002 2	02 Green
...	03 Grey	R Right	R Reverse printed	003 3	03 Grey
	04 Yellow	L Left		... etc	04 Yellow
	06 White	*Only for hinge-type caps			06 White
	08 Red	*In case of illumination			08 Red
	09 Black				09 Black
	16 Frosted white				... Etc
	...				

\*In case of reverse printed and laser marked legends the colour of the paint

























**Notice:** The size of the legends listed may not correspond to the actual size.

If you decide to use one of the standard legends without any adjustments (without a new cliché or programming) on another cap than designated in the table, then there is no cliché or programming cost, for this to apply the cap has to be black and the print white.

For further information on legends please contact your local distributor or MEC.

# Solid colors

Available for Multimec caps

CAP	CODE	Colour / RAL Code																		
		Blue / 5012	green / 6018	Grey / 7004	Yellow / 1023	White / 9010	Red / 3000	Black / 9004	Ultra blue / 5002	Mint green / 6029	Tele grey / 7046	Melon / 1028	Signal white / 9003	Noble red / 3002	Dusty blue / 5014	Aqua blue / 5021	Metal dark blue / No ral code	Metal light grey / No ral code	Metal dark grey / No ral code	Metal bordeaux / No ral code
1A		•	•	•	•	•	•	•												
1B		•	•	•	•	•	•	•												
1DS		•	•	•	•	•	•	•	•	•	•			•	•	•	•	•	•	•
1ES/1FS				•				•	•											
1GAS/1GCS		•	•	•	•	•	•	•												
1H				•				•												
1JS		•	•	•	•	•	•	•												
1KS		•	•	•	•	•	•	•												
1LS				•				•												
1M			•	•				•	•											
1NS				•				•												
1PS		•	•	•	•	•	•	•												
1QS		•		•				•												
1RS				•																
1SS		•	•	•	•	•	•	•												
1TS/1US/1VS		•		•				•	•											
1WAS/1WDS/1WPS				•				•												
1XS				•		•		•												
1ZA				•		•		•	•						•	•	•	•	•	•
1ZB				•		•		•	•						•	•	•	•	•	•
1ZCS				•		•	•	•	•						•	•	•	•	•	•
1Z/1ZW				•		•		•												
10A				•				•	•											
10C		•		•				•	•											
10R/10RF + 10Q		•	•	•	•	•	•	•												

The RAL Codes mentioned are the codes nearest to the solid colors in the multimec® range.

# Multimec® 5G

High performance tactile switches •  
MIL-PRF-28855H • excellent illumination



## DISTINCTIVE FEATURES

- Large range of accessories
- Momentary switches with NO or NC/NO function
- Sealed to IP67
- Single or bi-color illumination option
- Illumination with integrated chip-LEDs



## ENVIRONMENTAL SPECIFICATIONS

- Sealing : IP67 according to IEC 60529
- Working and storage temperature :
  - non-illuminated : -40 °C/+160 °C
  - illuminated : -30 °C/+85 °C
- Soldering :
  - through-hole : IEC 60068-2-20 8
  - surface mount : JEDEC J-STD-020E



## ELECTRICAL SPECIFICATIONS

- Recommended load :
  - Gold contacts : 0.5µ-50 mA 24 VDC
  - Silver contacts : 0.5-50 mA 24 VDC
- Contact resistance : <30 mΩ - typically 10 mΩ
- Insulation resistance : >10 MΩ
- Contact bounce : <2 mS - typically 0.5 mS



## MECHANICAL SPECIFICATIONS

- Standard actuation force :
  - momentary NO : 2.0 N, 3.5 N, 6.5 N
  - quiet version : 2.0 N
  - NC/NO function : 3.5 N
- Max. actuation force :
  - momentary : 115 N for 60 sec (according to MIL-PRF-22885H)
  - NC/NO : 100 N for 10 sec
- Travel : 1 mm
- Lifetime : >10,000,000 cycles

The company reserves the right to change specifications without notice.



## MATERIALS

- Housing : PPS UL94V0
- Actuator : PPS UL94V0
- Sealing : Silicone rubber
- Contacts spring : Stainless steel
  - Silver : +3 µAg
  - Gold : +1 µAu
- Fixed contacts :
  - Silver : SnCu + 2 µNI + 3 µAg
  - Gold : SnCu + 2 µNI + 1 µAu
- Terminals : SnCu + 2 µNI + 3 µSn100

All tolerance if not otherwise specified ±0.2 mm.

# Multimec<sup>®</sup> 5G

High performance tactile switches • MIL-PRF-28855H • excellent illumination

## 5G NON-ILLUMINATED

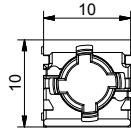

- SMD, TH or right angle TH
- NO or NC/NO

## 5G ILLUMINATED

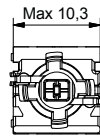

- SMD or TH
- NO
- single or bi-color LEDs

All tolerances unless otherwise noted : ±0.2 mm

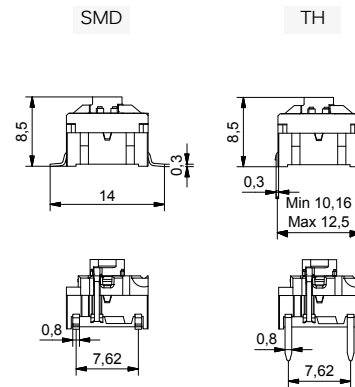
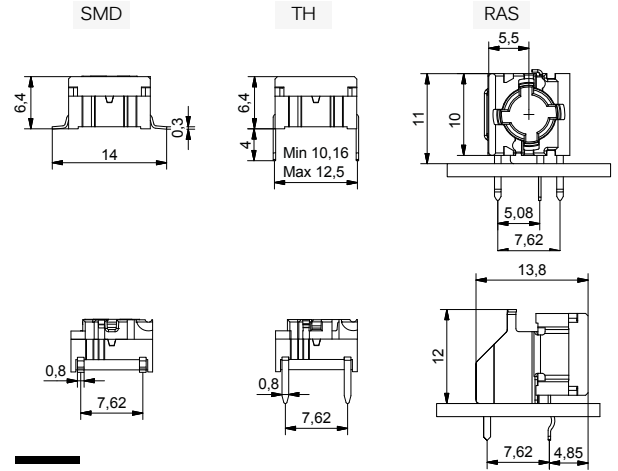

## PCB LAYOUT & CIRCUIT DIAGRAM

Non-illuminated

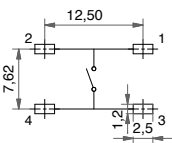
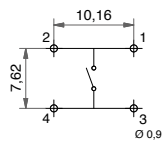

Single LED

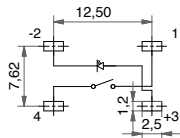
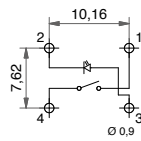

Bicolor - 2 LEDs

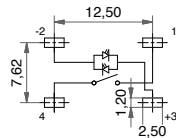
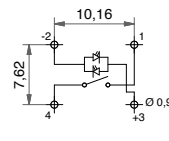

RAS

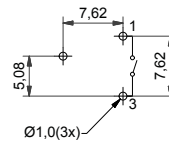

NC/NO function

\*not for sale in Japan

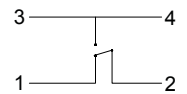



# Multimec® 5G

High performance tactile switches • MIL-PRF-28855H • excellent illumination



## BUILD YOUR PART NUMBER

**ILLUMINATED**

5G	—	—	—	—																																		
SERIES	MOUNTING	ACTUATION FORCE	LED	OPTIONAL																																		
	<table border="0"> <tr><td><b>TH9</b></td><td>Through-hole</td></tr> <tr><td><b>SH9</b></td><td>Surface mount</td></tr> </table>	<b>TH9</b>	Through-hole	<b>SH9</b>	Surface mount	<table border="0"> <tr><td><b>20</b></td><td>2.0 N</td></tr> <tr><td><b>35</b></td><td>3.5 N</td></tr> <tr><td><b>65</b></td><td>6.5 N</td></tr> </table>	<b>20</b>	2.0 N	<b>35</b>	3.5 N	<b>65</b>	6.5 N	<table border="0"> <tr><td><b>02</b></td><td>Blue</td></tr> <tr><td><b>22</b></td><td>Green</td></tr> <tr><td><b>29</b></td><td>High intensity Green</td></tr> <tr><td><b>42</b></td><td>Yellow</td></tr> <tr><td><b>61</b></td><td>White</td></tr> <tr><td><b>82</b></td><td>Red</td></tr> <tr><td><b>2242</b></td><td>Green/yellow</td></tr> <tr><td><b>8222</b></td><td>Red/green</td></tr> <tr><td><b>8242</b></td><td>Red/yellow</td></tr> </table>	<b>02</b>	Blue	<b>22</b>	Green	<b>29</b>	High intensity Green	<b>42</b>	Yellow	<b>61</b>	White	<b>82</b>	Red	<b>2242</b>	Green/yellow	<b>8222</b>	Red/green	<b>8242</b>	Red/yellow	<table border="0"> <tr><td><b>Q</b></td><td>Quiet contact (with 2.0 N only)</td></tr> <tr><td><b>R</b></td><td>Tape &amp; reel</td></tr> <tr><td><b>G</b></td><td>Gold contacts</td></tr> </table>	<b>Q</b>	Quiet contact (with 2.0 N only)	<b>R</b>	Tape & reel	<b>G</b>	Gold contacts
<b>TH9</b>	Through-hole																																					
<b>SH9</b>	Surface mount																																					
<b>20</b>	2.0 N																																					
<b>35</b>	3.5 N																																					
<b>65</b>	6.5 N																																					
<b>02</b>	Blue																																					
<b>22</b>	Green																																					
<b>29</b>	High intensity Green																																					
<b>42</b>	Yellow																																					
<b>61</b>	White																																					
<b>82</b>	Red																																					
<b>2242</b>	Green/yellow																																					
<b>8222</b>	Red/green																																					
<b>8242</b>	Red/yellow																																					
<b>Q</b>	Quiet contact (with 2.0 N only)																																					
<b>R</b>	Tape & reel																																					
<b>G</b>	Gold contacts																																					

**NON-ILLUMINATED**

5G	—	—	—																				
SERIES	MOUNTING	ACTUATION FORCE	OPTIONAL																				
	<table border="0"> <tr><td><b>TH9</b></td><td>Through-hole</td></tr> <tr><td><b>SH9</b></td><td>Surface mount</td></tr> </table>	<b>TH9</b>	Through-hole	<b>SH9</b>	Surface mount	<table border="0"> <tr><td><b>20</b></td><td>2.0 N</td></tr> <tr><td><b>35</b></td><td>3.5 N</td></tr> <tr><td><b>65</b></td><td>6.5 N</td></tr> </table>	<b>20</b>	2.0 N	<b>35</b>	3.5 N	<b>65</b>	6.5 N	<table border="0"> <tr><td><b>Q</b></td><td>Quiet contact (with 2.0 N only)</td></tr> <tr><td><b>RAS</b></td><td>Right angle (with TH only)</td></tr> <tr><td><b>NCNO</b></td><td>Normally closed/ normally open function (with 3.5 N only)</td></tr> <tr><td><b>R</b></td><td>Tape &amp; reel</td></tr> <tr><td><b>G</b></td><td>Gold contacts</td></tr> </table>	<b>Q</b>	Quiet contact (with 2.0 N only)	<b>RAS</b>	Right angle (with TH only)	<b>NCNO</b>	Normally closed/ normally open function (with 3.5 N only)	<b>R</b>	Tape & reel	<b>G</b>	Gold contacts
<b>TH9</b>	Through-hole																						
<b>SH9</b>	Surface mount																						
<b>20</b>	2.0 N																						
<b>35</b>	3.5 N																						
<b>65</b>	6.5 N																						
<b>Q</b>	Quiet contact (with 2.0 N only)																						
<b>RAS</b>	Right angle (with TH only)																						
<b>NCNO</b>	Normally closed/ normally open function (with 3.5 N only)																						
<b>R</b>	Tape & reel																						
<b>G</b>	Gold contacts																						



## ABOUT THIS SERIES



**Caps and accessories** : for the full range of accessories for Multimec 5G please see the website.

# Multimec<sup>®</sup> 5G

High performance tactile switches •  
MIL-PRF-28855H • excellent illumination



## TAPE & REEL

Tape and reel is available for the parts listed and has the following specifications

- Reel diameter: Ø330 mm
- Tape width: 24 mm
- Pitch: see list
- Tape and reel material: antistatic or better
- Quantity per reel: see list

PART NO.	ORDERING CODE	PITCH	QUANTITY PER REEL
5GSH9XX	5GSH9XXR	16	500
5GSH9XX1SSXX-08.0	5GSH9XXR1SSXX-08.0	20	250
5GSH9XX1SSXX-09.5	5GSH9XXR1SSXX-09.5	20	250
5GSH9XX1SSXX-10.4	5GSH9XXR1SSXX-10.4	20	250
5GSH9XX1SSXX-11.0	5GSH9XXR1SSXX-11.0	20	250
5GSH9XX1SSXX-12.0	5GSH9XXR1SSXX-12.0	20	250
5GSH9XX01	5GSH9XX01R	20	250
5GSH9XX22	5GSH9XX22R	20	250
5GSH9XX42	5GSH9XX42R	20	250
5GSH9XX61	5GSH9XX61R	20	250
5GSH9XX82	5GSH9XX82R	20	250
5GSH9XX2242	5GSH9XX2242R	20	250
5GSH9XX8222	5GSH9XX8222R	20	250
5GSH9XX8242	5GSH9XX8242R	20	250



## OPERATING FORCE

2.0 N

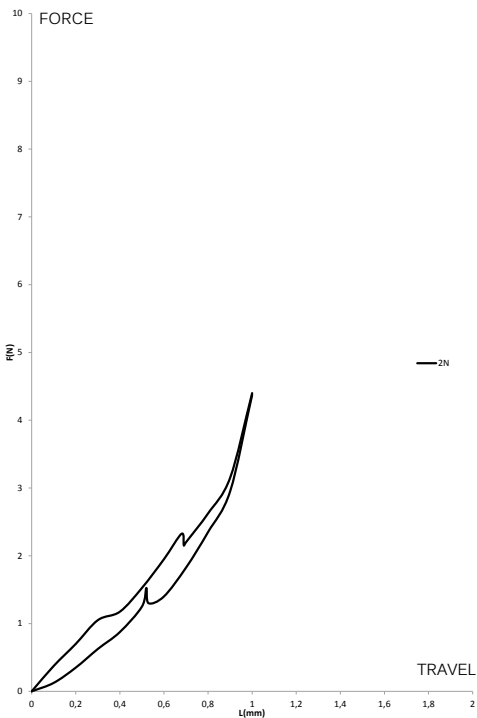

3.5 N

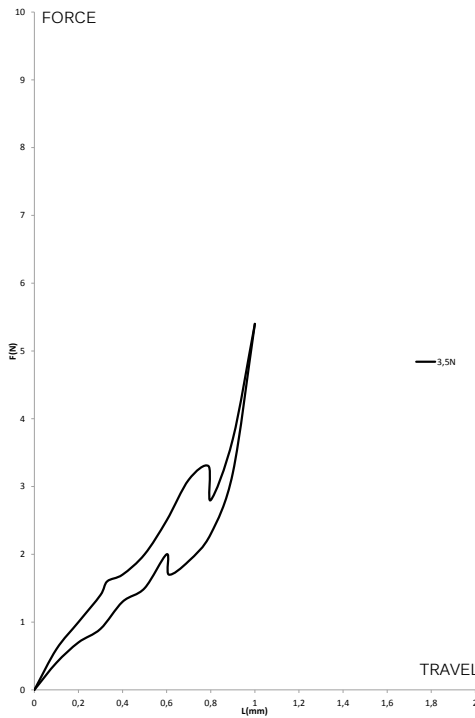

6.5 N

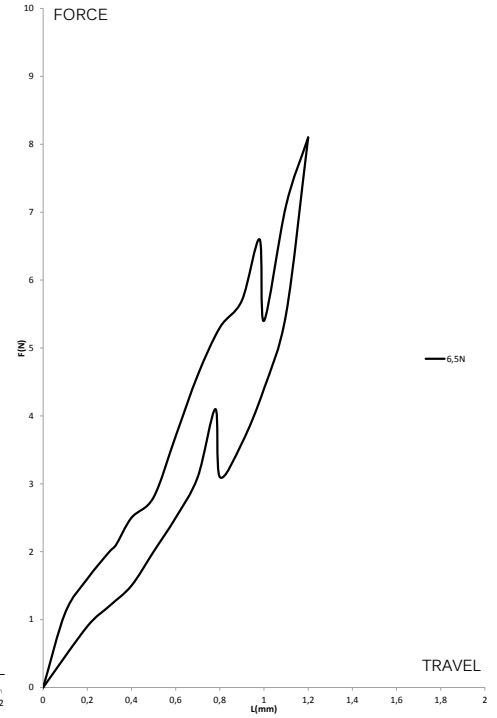

High performance tactile switches • MIL-PRF-28855H • excellent illumination



## MOUNTING (CONTINUED)

### MOUNTING TOOLS FOR MULTIMEC® THROUGH-HOLE SWITCHES

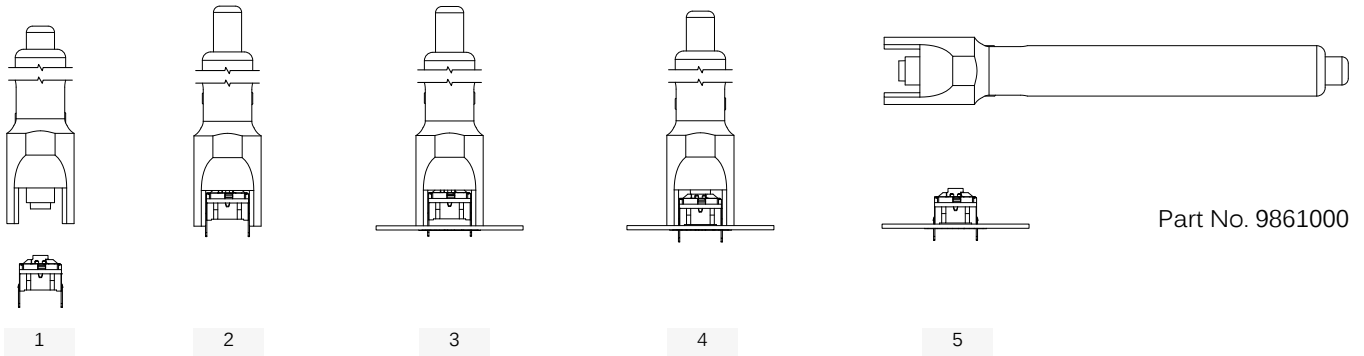

### SPACE REQUIREMENT - MATRIX MOUNTING

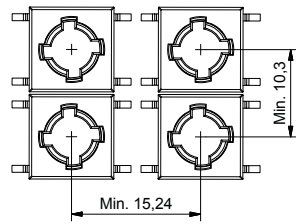
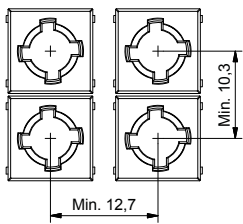

### MULTIMEC® SPACING EXAMPLES

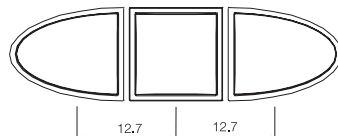
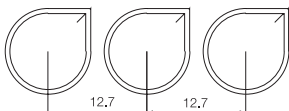
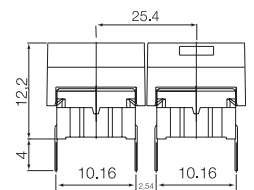
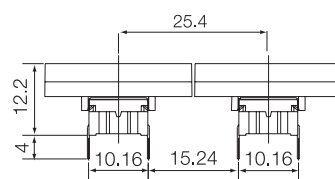
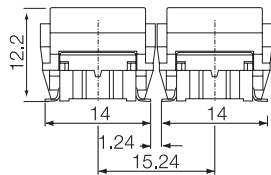
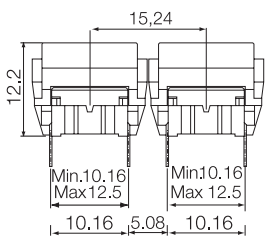

# Multimec<sup>®</sup> 5G

High performance tactile switches •  
MIL-PRF-28855H • excellent illumination



## MOUNTING (CONTINUED)

SPACE REQUIREMENT - SWITCH/CAP

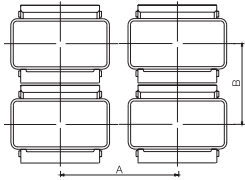

Switch spacing

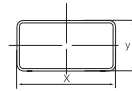

Cap dimensions

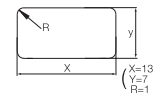

Panel cut-out

CAP SERIES	RECOMMENDED MIN. SWITCH SPACING AxB	NOMINAL CAP DIMENSION WxH	RECOMMENDED MIN. PANEL CUT-CUT
1A/1H	12.7x10.16	12.6x10.1	13.0x10.5
1B/1C+2C/2D	15.24x15.24	15.1x15.1	15.5x15.5
1DS/1ES/1FS	12.7x12.7	Ø9.6	Ø10
1GAS	12.7x11.14	Ø11	Ø11.4
1GCS	15.14x15.14	Ø15	Ø15.4
1JS	12.7x12.7	Ø9.6	Ø10.4
1KS/1KBS/1KCS	15.24x15.24	14.3x14.3	14.7x14.7
1M	25.4x10.16	25x10	27.7x10.5
1NS	12.7x12.7	Ø9.8/ □4.9	Ø10.2/□5.1
1PS/ 1QS/1RS	15.24x10.16	6.5x12.5	7x13, R max. 1.0
1SS/1IS/1LS	12.7x12.7	Ø6.5	Ø7
1TS	12.7x12.7	10.6x10.6	11x11
1US	12.7x12.7	Ø10.6	Ø11.0
1VS	12.7x12.7	10.6x13.25	11.0x13.65
1WAS/1WPS	12.7x10.3	12.5x6.5	12.9x6.9
1WDS	15.34x10.3	15.2x8.0	15.6x8.4
1XS	12.7x12.7	9.4x7.4	9.8x7.9
1YS	17x17	15x15	16x16
1ZA	18.84x10.3	18.7x10.1	19.4x10.5
1ZB	24.34x12.1	R1=7.4; R2=17.5 90°	R1=7.1; R2=17.5-17.75 90°
1ZCS	14.44x14.44	Ø14.3	Ø14.7
1Z/1ZW	35.5x35.5; 41.6x41.6	Ø29.5	Ø30.3
10A	17x35	R=5.3; 10.6x28	R=5.5; 11x28.4
10C	non-ill: 24 x 24; ill.: 30.2 x 30.2	Ø19.2	Ø19.8
10R/10RF/10RM	40.5x40.5	Ø30.0	Ø30.6
10Q/10QM	32.5x32.5	22x22	22.5x22.5



## LED COMPONENT SPECIFICATIONS

LED COMPONENT SPECIFICATIONS							
Color		Blue	Green	Yellow	White	Red	High Intensity Green
Color Codes		02	22	42	61	82	29
ABSOLUTE MAXIMUM RATINGS (Ta= 25°C)							
Power	mW	110	75	60	48	65	102.5
Current forward	mA	25	30	25	15	25	25
Forward peak current	mA	100	80	60	100	100	150
Voltage reverse	V	5	5	5	NA	12	5
Operating temperature	°C	-40/+85	-55/+85	-40/+85	-40/+85	-30/+85	-40/+85
Storage temperature	°C	-40/+90	-55/+85	-40/+90	-40/+85	-40/+85	-40/+85
Soldering temperature	°C	245 for max 10 sec					
ELECTRICAL-OPTICAL CHARACTERISTICS (Ta=25 °C)							
Voltage forward	Typ. V	3.3	2	1.75**	2.85	2	3.3
	Max. V	3.7	2.4	2.35	3.1	2.5	4.1
Current reverse (VR=5V)	Max. µA	50	100	10	NA	100	50
Wave length	nm	470	571	591	NA	633	525
Spread	Δnm	25	NA	15	NA	16	30
Spread angle	degree	120	130	120	150	160	60
Luminous Intensity	Min. mcd	45	18	28.5	71	28	500
	Typ. mcd	122*	35	72*	224*	180*	1000
Optical intensity	Lm/w	NA	NA	NA	36	7	NA

\*F=20 mA, \*\*Pulse width 1ms Duty cycle 1:5, \*\*\*F=50 mA, \*\*\*\*Luminous Flux mlm

# Multimec® 5G

High performance tactile switches • MIL-PRF-28855H • excellent illumination



## USAGE GUIDELINES

### HOW TO GET THE BEST RESULTS WITH MEC SWITCHES ?

These guidelines are offered to users of MEC Switches as an aid to ensure successful and reliable switch operation. Please see the technical specifications for details on operating and storage temperatures and soldering guidelines to make sure you select the best switch for your application. When wave soldering is taking place, MEC strongly recommend that the temperature profile is analyzed and compared with the temperature rating of the switch. It is also important to monitor the accumulated heat buildup from both the pre-heat zones and the solder zone.

Most standard accessories for multimec® 5 series switches are made from ABS plastic with a maximum operating temperature of 65 °C. It is strongly recommended that accessories are mounted after soldering of the switch. If this is not possible care must be taken not to overheat the accessories during the soldering process. The 1SS and 1GAS/1GCS caps are, however, made of high temperature materials and will meet the same temperature specifications as the switches. For accessories made from other plastic materials please see multimec® 5 series technical specifications.

LEDs have their own temperature specifications. When fitted in a switch the LED will determine the max. operating temperature, i.e. 5GTH93522 has an upper temperature limit of 85 °C!

### MOUNTING AND DISMOUNTING

If switches are to be mounted in rows it is essential that the recommendations regarding spacing are followed. PC board thickness should be 1.4 ±0.2 mm and terminal hole diameter should be 0.9 mm.

All multimec® 5 series caps and bezels are easily snapped onto the switch modules and can be changed at a later time.

A mounting tool is available for through hole multimec® 5 series switches.

### SOLDERING AND CLEANING MULTIMEC® SERIES

Multimec® 5 series switches are fully sealed to IP67 specifications to minimize solder flux and aqueous based cleaning solutions from entering the switch and contaminating the contacts. The switches can be placed on the PC board with other components and wave soldered. Multimec® 5 series offers a high level of sealing, however, with aqueous solvent solutions care must be taken to avoid the worst

case situation with water jets, complete immersion into a liquid with a temperature below the board or surface tension reducing additives.

Recommended cleaning methods are demineralized water. Any surface tension reducing agents, such as soap, must not be used as they risk causing a potential leakage of the switch.

### SOLDERING - THROUGH HOLE VERSIONS

**Hand soldering:** max. 350 °C for max. 3 sec

**Wave soldering:** heat built up in the switch during pre-heating and soldering must not exceed the maximum operating temperature of the switch. Peak temperature must not exceed 260 °C, and soldering time is max 10 sec. (IEC 60068-2-20 8)

### SOLDERING - SURFACE MOUNT VERSIONS

For all methods - infrared, convection and vapor phase. The upper limit 260 °C/30 sec must be observed. The soldering temperature profile must have moderate temperature gradients. (JEDEC J-STD-020E)

### ROHS COMPLIANCE

As of 1 July 2006 MEC has completed the conversion to RoHS compliance. For more info please see our homepage [www.apem.com](http://www.apem.com)

### TEMPERATURE LIMITS:

Switch	160 °C
LEDs	85/90 °C
Accessories	65/85/160 °C

### PACKAGING

Multimec® 5 series switches are packed in rigid tubes of 50 pieces each.

A box contains 1.000 pcs.

The surface mount versions of multimec® 5 series switches with a height up to 12.5 mm can also be delivered on tape/reel. Each reel contains 250/500 pcs.

# Mouser Electronics

Authorized Distributor

Click to View Pricing, Inventory, Delivery & Lifecycle Information:

[Apem:](#)

[10C1616LMH11809](#) [10C0016](#) [10C0916](#) [10C0816](#) [10C091612306](#) [10C1616](#) [10C1616LMH12309](#)