

# PC series

## Ergonomic pendant controllers

Distinctive features and specifications



- Analog voltage or USB interface
- Readily available with TS series Thumbstick
- Optional sealing up to IP67
- Designed for optimal ergonomics
- Custom configurations available

### TYPICAL MECHANICAL SPECIFICATIONS

#### TS SERIES THUMBSTICK (PN TS1R2S00A)

- Operating Force: 3.1N±0.5N
- Maximum Vertical Load: 200N (45lbf)
- Maximum Horizontal Load: 150N
- Travel Angle: ± 25°
- Expected Life: 1 million cycles
- Lever Action (centering): Spring centering

#### IP SERIES PUSHBUTTON (PN IPP3SAD2LOG)

- Total Travel: 1.7mm (0.067)
- Operating Force: 6N ± 2N
- Mechanical Life: 1 million cycles

### ENVIRONMENTAL

- Operating Temperature: -40°C to +85°C (-40°F to +185°F)
- Storage Temperature: -40°C to +85°C (-40°F to +185°F)
- Optional sealing up to IP67 & IP69K

### MATERIALS

- Case: Thermoplastic, black

### ELECTRICAL - USB OPTIONS

- Power (via the USB interface): 5VDC, Consumption 100mA
- Cable: USB Type A male connector
- Cable length: 7'

### SUPPORTED PROTOCOLS

- USB HID 1.1 game controller
- DirectX (Gaming Control)
- Uses standard Direct X HID drivers

#### NOTES:







**Notice:** Exact specifications may be subject to configuration. Contact Technical Support for the performance of your specific configuration.

# PC series

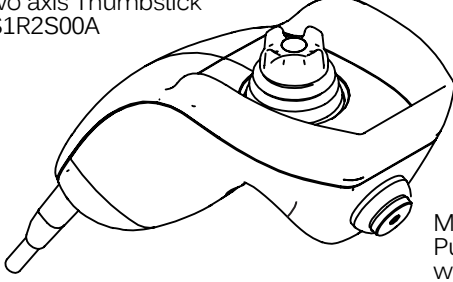
## Ergonomic pendant controllers

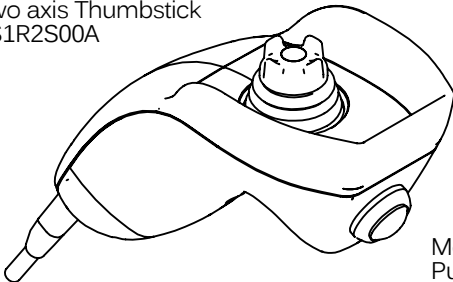
### Overview

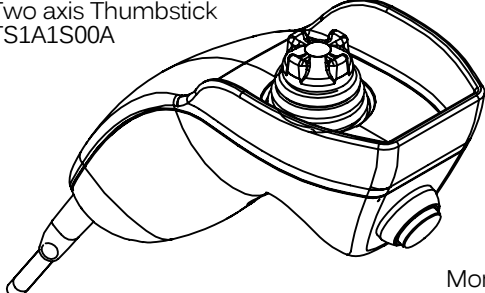
<p>Two axis TS and momentary pushbutton with LED</p> 	<p>Part number <b>PC2430</b></p> <p>Two axis Thumbstick TS1R2S00A</p>  <p>Momentary Pushbutton with Green LED IPP3SAD2LOG</p> <p>OUTPUT - USB "Game Controller"</p>
<p>Two axis TS and momentary pushbutton</p> 	<p>Part number <b>PC2441</b></p> <p>Two axis Thumbstick TS1R2S00A</p>  <p>Momentary Pushbutton ISR3SAD100</p> <p>OUTPUT - USB "Game Controller"</p>
<p>Two axis TS with momentary pushbutton, coiled cable</p> 	<p>Part number <b>PC3566</b></p> <p>Two axis Thumbstick TS1A1S00A</p>  <p>Momentary pushbutton ISR3SAD600</p> <p>OUTPUT - 0V to 5V</p>

### HANDLE DIMENSIONS

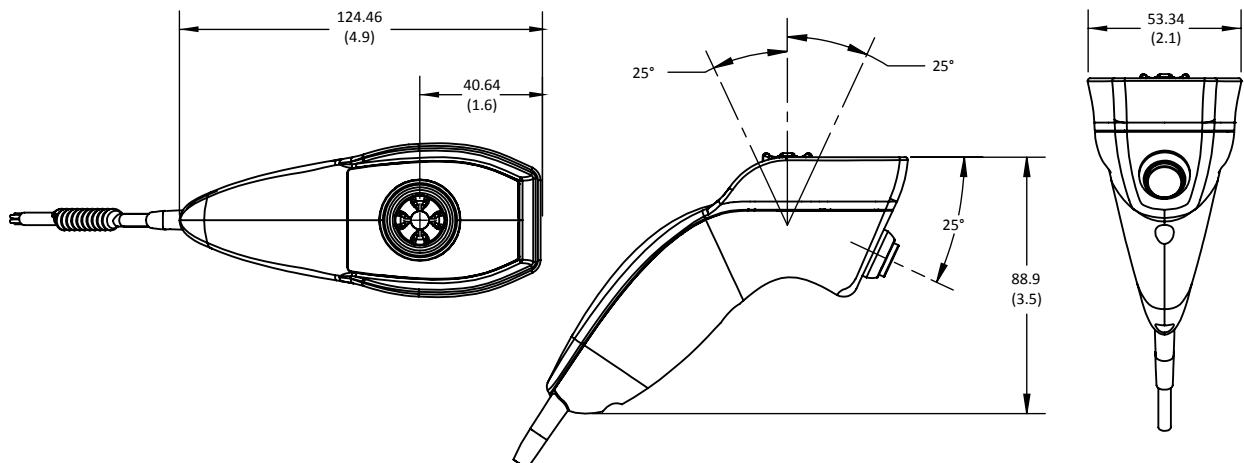

# Mouser Electronics

Authorized Distributor

Click to View Pricing, Inventory, Delivery & Lifecycle Information:

[Apem:](#)

[PC3566](#) [PC2430](#) [PC2441](#)