

BF series

Paddle controllers

Distinctive features and specifications



- Hall effect joystick and switch function
- Sculpted ergonomic design
- Next generation Hall effect technology
- 5V operation - dual redundant outputs as standard
- Two lever height variants
- Industry standard connector
- IP67 sealed
- Sprung and detent lever options
- Available with color-coded inserts
- EMC & Magnetically shielded - analog or PWM outputs
- Effectively zero below panel depth
- End stackable mounting

MECHANICAL

- Materials Employed: Polyetherimide, Polycarbonate, Stainless Steel
- Weight: 50g
- Mechanical Operating Angle: ± 25 Degrees
- Max Load to Mechanism:
 - Vertical: IK08 (BSEN62262:2002)
 - Horizontal: 75N (16.86lbf)

ELECTRICAL

- Gain (Output Voltage Span): $\pm 10\% \times V$ to $\pm 50\% \times V$
- Output at Center: $V/2 \pm (5\% \times \text{Gain})$
- Power Supply: 5V $\pm 0.5V$ Transient free
- Switch Outputs: Open Drain, pulled high within control via 1K5 to 5V, and smoothed to 0V with 100nF
- Sensor Type: Hall effect
- Current Consumption: $< 20\text{mA}$
- Loads: Minimum 10K, preferred 100K+

ENVIRONMENTAL

- Storage: -40°C to 70°C (-40°F to 158°F)
- Operating Temperature: -25°C to 70°C (-13°F to 158°F)
- Seal Above Panel: IP67 (Gasket fitted as standard)
- EMC Emissions: Complies with EN 61000-6-3:2001 CISPR 22:2005 Class B 30MHz - 11GHz
- Life Cycles: 5 million cycles sprung version only. Detents rated to 2 million cycles
- ESD: Complies with EN61000-4-2 (extended) $\pm 8\text{KV}$ (20 contacts) & $\pm 15\text{KV}$ (20 air discharges)
- EMC Immunity: 100V/m, 80MHz-2.7GHz, 1KHz 80% sine wave modulation, EN 61000-4-3 (extended)
- Vibration: 100Hz - 200Hz @ $0.13\text{g}^2/\text{Hz}$, total 3.6gRMS (1 Hour in each of the three mutually perpendicular axis)

NOTES:

1. All parameters shown are based on a standard configuration and are provided for guidance only.
2. Please refer to APEM for assistance on how to achieve the best performance from your chosen configuration.

BF series

Paddle controllers

Overview

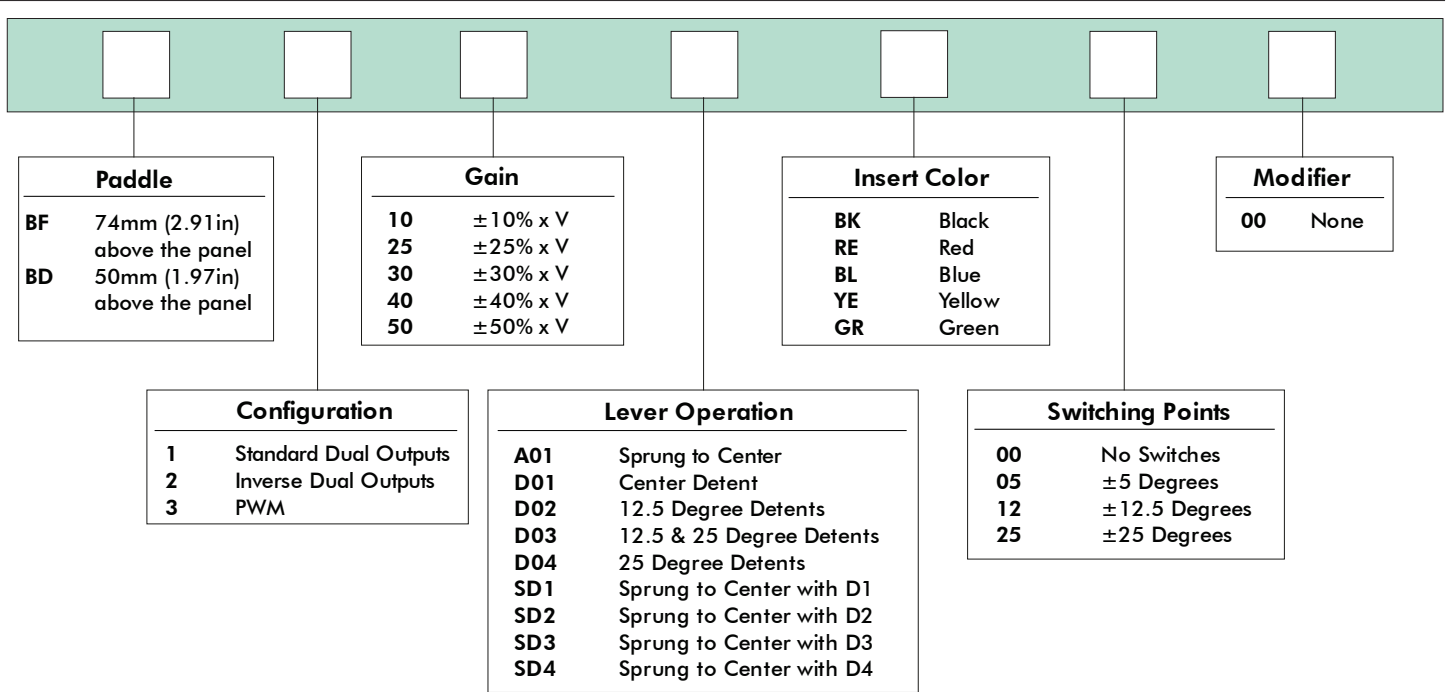

LEVER OPERATION

DETENT OPTIONS

D01 = CENTER DETENT

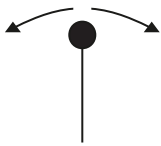

D02 = +/-12.5 DEGREES

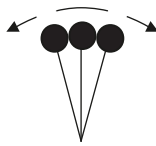

D03 = +/- 12.5 & 25 DEGREES

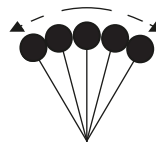

D04 = +/-25 DEGREES

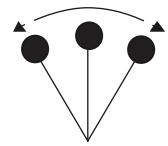

SPRUNG TO CENTER WITH DETENT OPTIONS

SD1 = CENTER DETENT

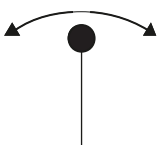

SD2 = +/-12.5 DEGREES

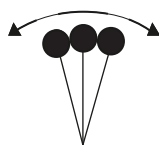

SD3 = +/- 12.5 & 25 DEGREES

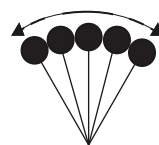

SD4 = +/- 25 DEGREES

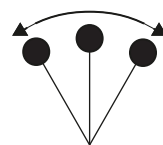

BF series

Paddle controllers

Overview

GENERAL DIMENSIONS

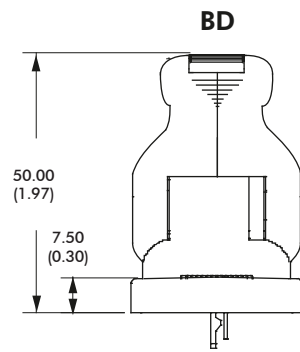
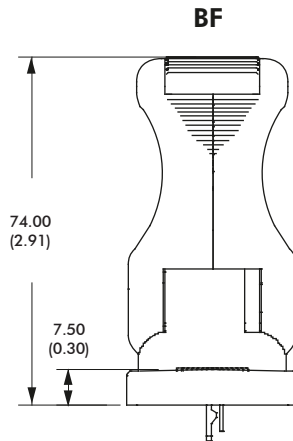
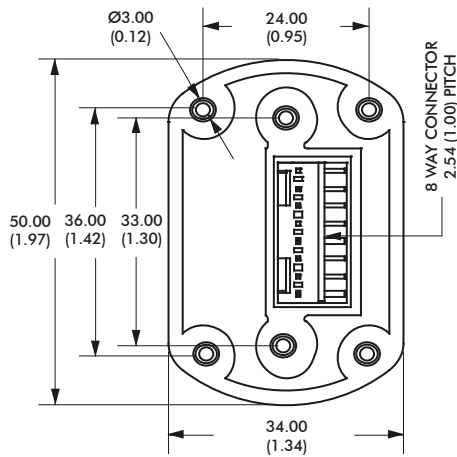

DROP IN MOUNTING - PANEL CUT-OUT & MOUNTING INSTALLATION

The Paddle may be mounted with two different hole patterns:

- Two screws – in line on the Y axis (shown as yellow screws)
- Four screws – one in each corner (shown as silver screws)

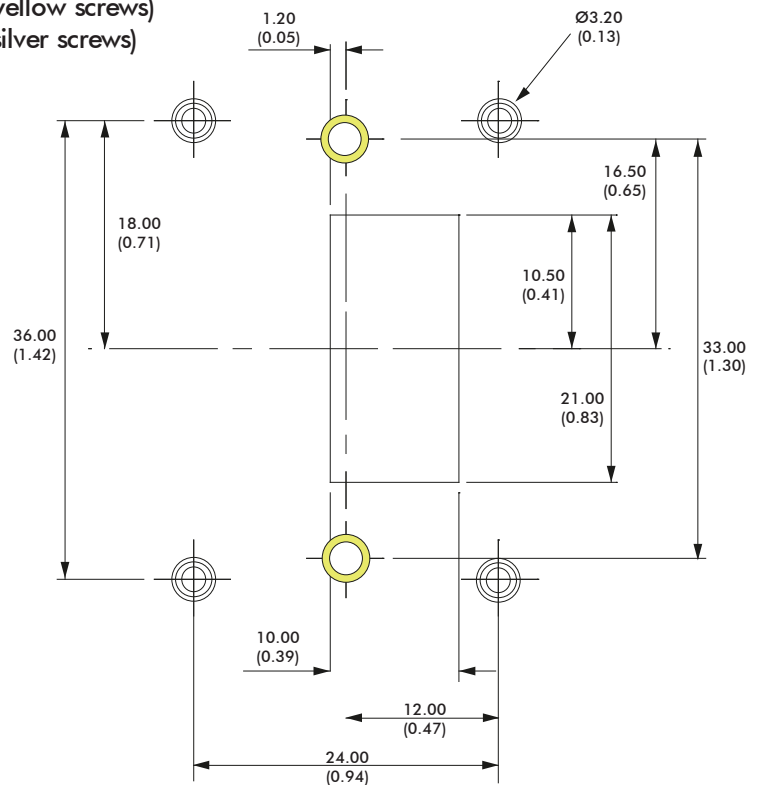

The Paddle is fitted with M3 bushes in all six positions, as standard.
Fasteners are not supplied as standard. The appropriate length of fastener is dependent on panel thickness.

NOTE: All dimensions in mm/(inch).

BF series

Paddle controllers

Overview

MECHANISM

The brand new mechanism design has been developed for strength and long life while retaining a superb feel.

SPRUNG TO CENTER

The lever springs back to the center position when released.

DETENT POSITIONS

The lever 'clicks' into a number of preset positions. The internal switches can be configured to trigger at two of these points.

DETENT POSITIONS WITH SPRUNG TO CENTER

The lever 'clicks' into a number of preset positions and springs back to its center position when released.

CONNECTIONS

The Paddle is fitted, as standard, with an industry standard 2.54mm pitch 8 way connector.

CONNECTIONS

Paddles are supplied with an eight way connector as standard.

- PIN 1: 5V
- PIN 2: Switch 1(+)
- PIN 3: 0V
- PIN 4: Analog/PWM output 1
- PIN 5: Analog/PWM output 2
- PIN 6: 0V
- PIN 7: Switch 2 (-)
- PIN 8: 5V

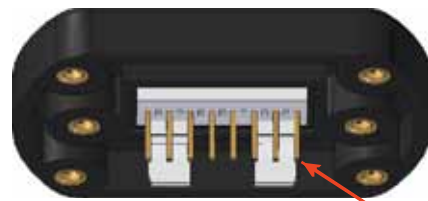

PIN 1

BF SERIES OUTPUT CHARACTERISTICS - 40% GAIN DUAL INVERSE OUTPUTS

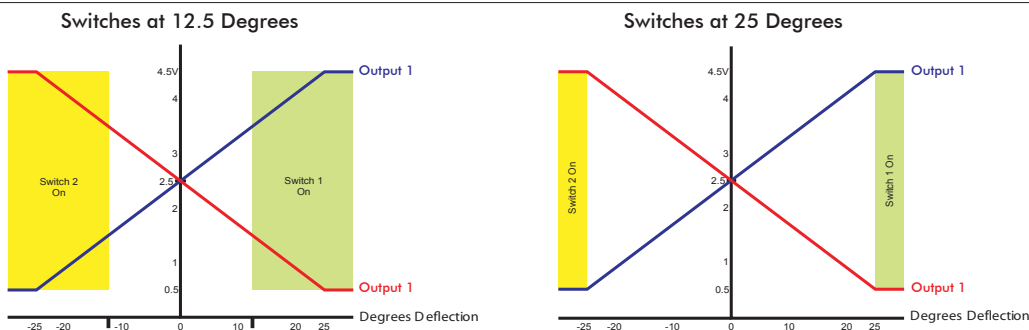

Equivalent circuit for the switch output

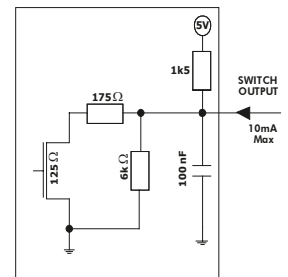

40% GAIN DUAL OUTPUTS

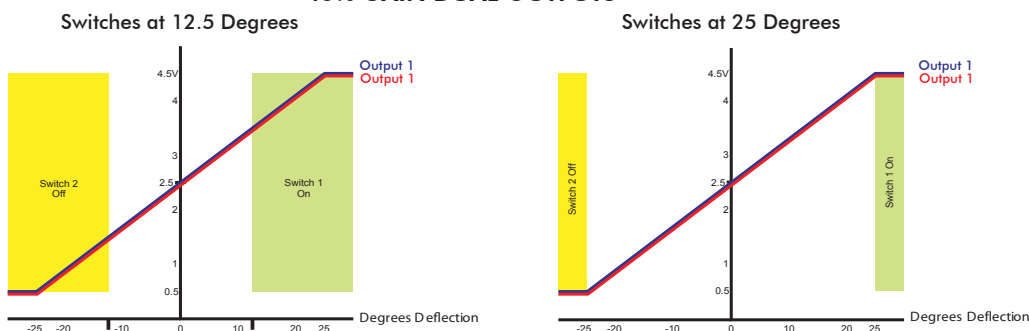

Note: When Dual Output (non-inverted) option is selected the polarity of Switch 2 is inverted

Note: The company reserves the right to change specifications without notice.

BF series

Paddle controllers

Overview

OUTPUT OPTIONS

The BF series Paddle is configured as two “electrical” controls in one mechanical package. The Paddle operates from 5V and provides two proportional outputs. The second output is accurate to the first within $\pm 3\%$ of the power supply. The power supply for the secondary output is also completely independent. Customers may choose their preference of voltage outputs (gains).

The secondary output can be of the same or inverse polarity to the primary wiper. For example, with a secondary inverse output, the first and second outputs can be summed and compared to zero to verify that the joystick is operating correctly. Paddles having two identical outputs of the same polarity may be used to drive two identical dual redundant circuits.

There are also two Hall effect switches that trigger at pre-determined lever positions.

The BF series Paddle may be specified with a variety of PWM output options. For more details on available PWM options please refer to APEM.

ADDITIONAL OUTPUT INFORMATION

SELECTABLE SWITCHING POINTS

The Paddle incorporates two Hall effect switches. The angle of the lever at the switch trigger point can be selected when ordering.

If no switches are specified then the output on pins 2 and 7 will be unused.

The outputs are configured as ‘open drain’ type with a 1K5 pull up resistor to 5V.

GAIN OPTIONS

The voltage output on the wiper, at full scale deflection is determined by the gain. The gain is expressed as a percentage of the voltage supplied. Therefore (assuming a 5V supply) a Paddle specified with $\pm 25\%$ gain would yield 1.25V at South, 2.5V at center and 3.75V at North. A range of gain options are available as standard. All controls are supplied pre-set and no further calibration is needed throughout the lifetime of operation.

OUTPUT IMPEDANCE

The voltage outputs at center and at each end of travel are specified across an infinite load, with no current flowing. The output impedance specified in the electrical specification should be taken into account when designing a system. Load resistance of less than 10K Ohms is not recommended.

HANDLE OPTIONS

The BF series offers two standard handle options. The taller (74mm) handle provides the most ergonomic solution while the shorter (50mm) is best suited to hand held applications where a minimized height is preferred. The taller lever is supplied with the top insert prefitted, however the shorter lever may be specified with no insert fitted and the snap in inserts supplied loose for ease of customer integration.

Note: All snap in inserts may only be fitted once, and are not removable once fitted.

BF series

Paddle controllers

Overview

VOLTAGE OUTPUT OPTIONS

DUAL OUTPUT - CONFIGURATION 3

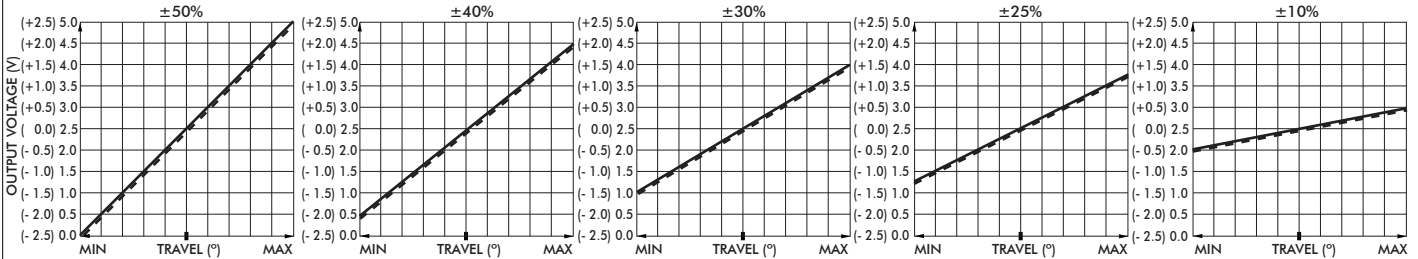

DUAL OUTPUT - CONFIGURATION 4

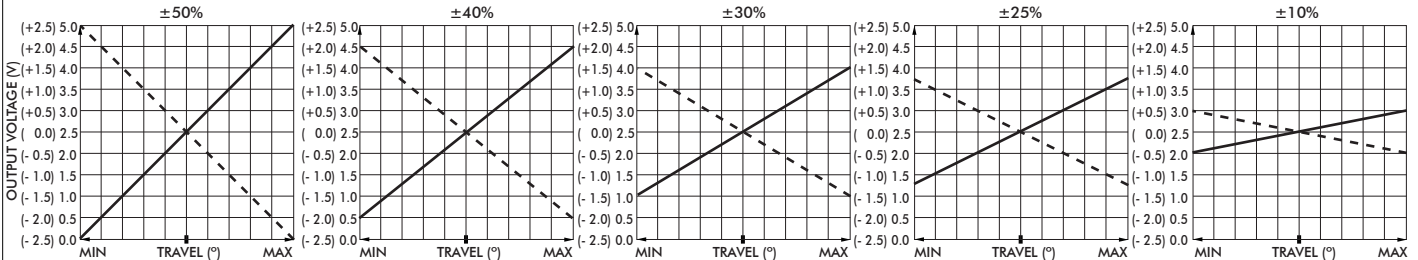

— Output 1
- - - Output 2

POWER SUPPLY

The BF Series is designed to be powered by a regulated $5V \pm 0.5V$ power supply. The outputs are ratiometric, making a stable, noise free, power supply essential. The power supply to the joystick should be carefully regulated to be within tolerance. Should the power supply change outside of the specified tolerances, permanent damage may occur.

MAGNETIC IMMUNITY AND SYSTEM DESIGN

The BF Series incorporates internal magnetic screening to minimize the effect of external magnetic fields. Mounting or operating the Paddle close to strong magnetic fields is not recommended. System designers should follow best practice when incorporating the BF Series Paddle into their products. Care should be taken to decouple the power supply properly and to employ adequate EMC shielding.

MOUNTING

When mounting the Paddle, care should be taken to site it in a position that does not make it vulnerable to damage when in use. If the Paddle is intended for use in a handheld enclosure then care must be taken to protect the Paddle from damage caused by dropping. Basic precautions such as mounting it at the lightest end of the enclosure so it doesn't hit the ground first or by protecting it with a guard should always be implemented for long term reliability. The body of the Paddle, on the underside of the panel, must not be subject to water spray, excessive humidity or dust.



Note: The company reserves the right to change specifications without notice.

Mouser Electronics

Authorized Distributor

Click to View Pricing, Inventory, Delivery & Lifecycle Information:

[Apem:](#)

[BF140A01RE0000](#)