



# MPSA13 MPSA14

## NPN Silicon Darlington Transistor

### Features

- Halogen free available upon request by adding suffix "-HF"
- Capable of 1.5Watts of Power Dissipation.
- Collector-current 500mA
- Collector-base Voltage 30V
- Operating and storage junction temperature range: -55°C to +150°C
- Epoxy meets UL 94 V-0 flammability rating
- Moisture Sensitivity Level 1
- Marking:MPSA13--MPSA13,MPSA14--MPSA14.
- Lead Free Finish/RoHS Compliant ("P" Suffix designates RoHS Compliant. See ordering information)

### Maximum Ratings

Symbol	Rating	Rating	Unit
V <sub>CES</sub>	Collector-Emitter Voltage	30	V
V <sub>CBO</sub>	Collector-Base Voltage	30	V
V <sub>EBO</sub>	Emitter-Base Voltage	10	V
I <sub>C</sub>	Collector Current Continuous	500	mA
P <sub>D</sub>	Total Device Dissipation @T <sub>A</sub> =25°C	625	mW
	Derate above 25°C	5.0	mW/°C
P <sub>D</sub>	Total Device Dissipation @T <sub>A</sub> =25°C	1.5	W
	Derate above 25°C	12	mW/°C
T <sub>J</sub>	Junction Temperature	-55 to +150	°C
T <sub>STG</sub>	Storage Temperature	-55 to +150	°C

### Electrical Characteristics @ 25°C Unless Otherwise Specified

Symbol	Parameter	Min	Max	Units
--------	-----------	-----	-----	-------

#### OFF CHARACTERISTICS

V <sub>(BR)CES</sub>	Collector-Emitter Breakdown Voltage (I <sub>C</sub> =100μAdc, I <sub>B</sub> =0)	30		Vdc
I <sub>CBO</sub>	Collector Cutoff Current (V <sub>CB</sub> =30Vdc, I <sub>E</sub> =0)		100	nAdc
I <sub>EBO</sub>	Emitter Cutoff Current (V <sub>EB</sub> =10Vdc, I <sub>C</sub> =0)		100	nAdc

#### ON CHARACTERISTICS<sup>(1)</sup>

h <sub>FE(1)</sub>	DC Current Gain (I <sub>C</sub> =10mAdc, V <sub>CE</sub> =5.0Vdc)	MPSA13 MPSA14	5000 10000		
h <sub>FE(2)</sub>	DC Current Gain (I <sub>C</sub> =100mAdc, V <sub>CE</sub> =5.0Vdc)	MPSA13 MPSA14	10000 20000		
V <sub>CE(sat)</sub>	Collector-Emitter Saturation Voltage (I <sub>C</sub> =100mAdc, I <sub>B</sub> =0.1mAdc)			1.5	Vdc
V <sub>BE(on)</sub>	Base-Emitter Saturation Voltage (I <sub>C</sub> =100mAdc, V <sub>CE</sub> =5.0Vdc)			2.0	Vdc

#### SMALL-SIGNAL CHARACTERISTICS

f <sub>T</sub>	Current-Gain – Bandwidth Product <sup>(2)</sup> (I <sub>C</sub> =10mAdc, V <sub>CE</sub> =5.0Vdc, f=100MHz)	125		MHz
----------------	--	-----	--	-----

1. Pulse Test: Pulse Width<300us, Duty Cycle<2.0%
2. f<sub>T</sub>=|h<sub>fe</sub>| x f<sub>test</sub>

### TO-92

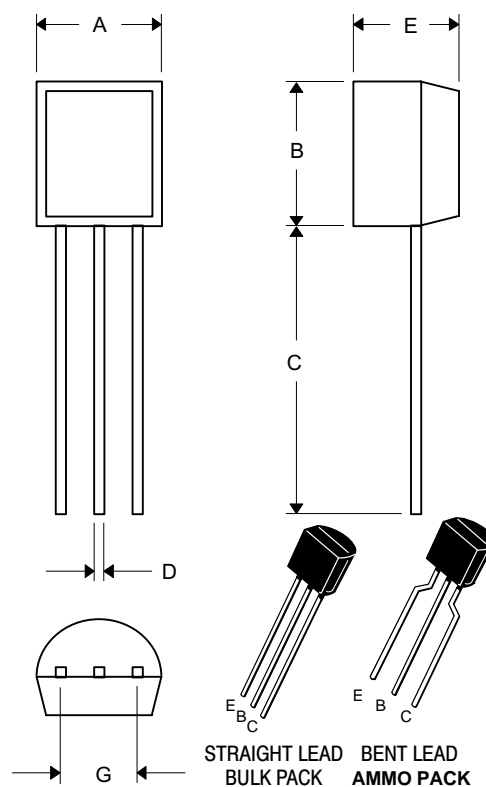

STRAIGHT LEAD BULK PACK BENT LEAD AMMO PACK

#### DIMENSIONS

DIM	INCHES		MM		NOTE
	MIN	MAX	MIN	MAX	
A	.175	.185	4.45	4.70	
B	.175	.185	4.45	4.70	
C	.500	---	12.70	---	
D	.016	.020	0.41	0.63	
E	.135	.145	3.43	3.68	
G	.095	.105	2.42	2.67	Straight Lead
	.173	.220	4.40	5.60	Bent Lead

\* For ammo packing detailed specification, click here to visit our website of product packaging for details.

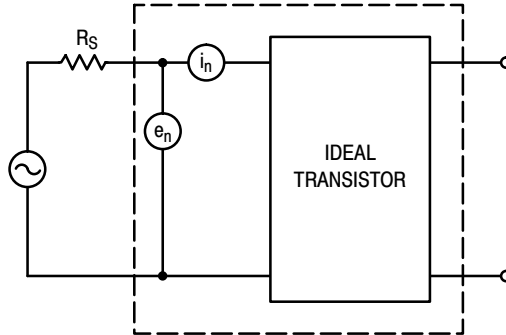

**Figure 1. Transistor Noise Model**

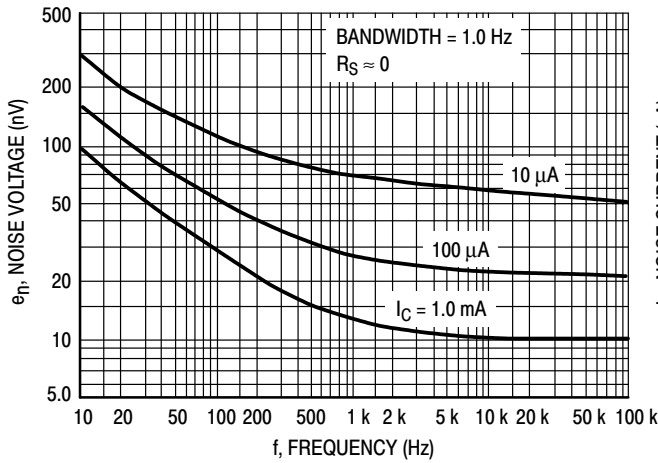

**Figure 2. Noise Voltage**

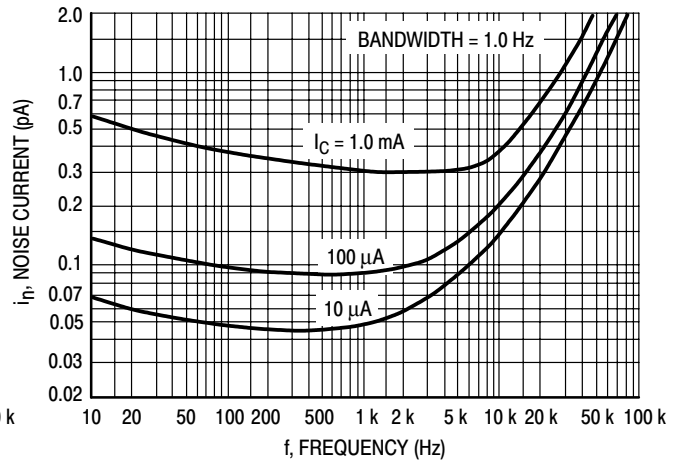

**Figure 3. Noise Current**

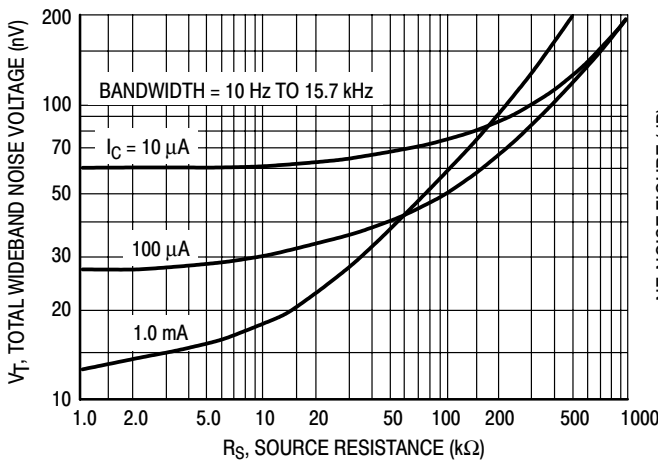

**Figure 4. Total Wideband Noise Voltage**

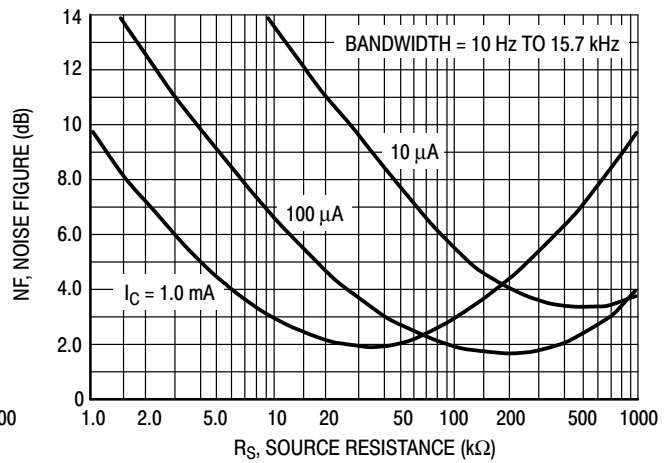

**Figure 5. Wideband Noise Figure**

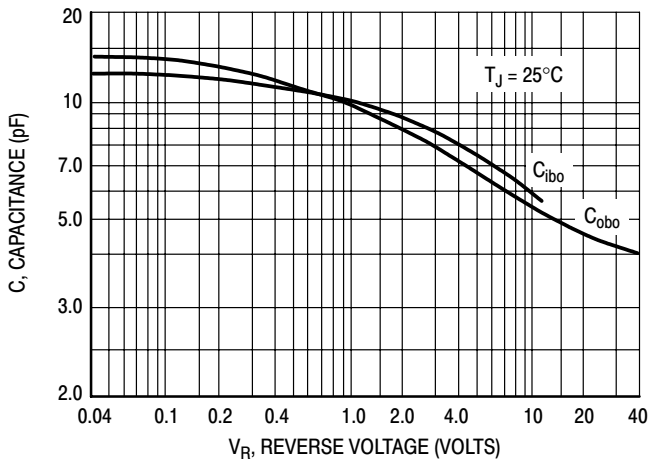

Figure 6. Capacitance

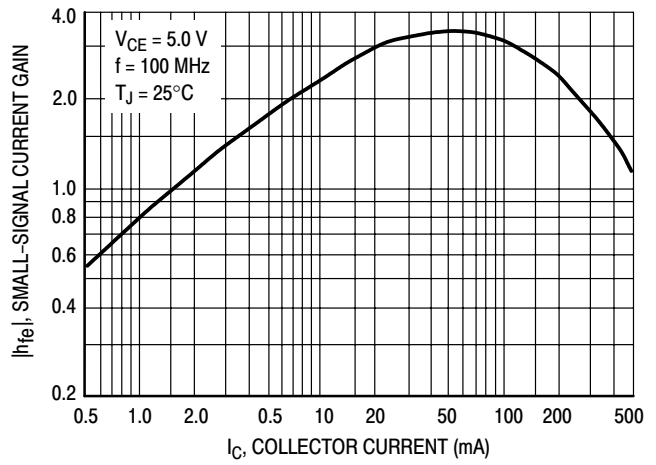

Figure 7. High Frequency Current Gain

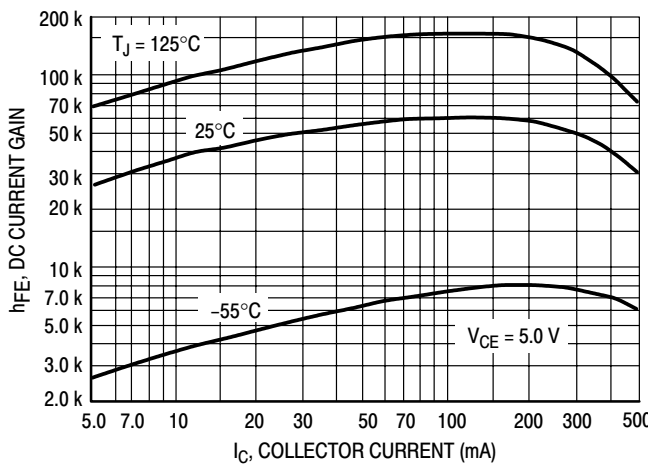

Figure 8. DC Current Gain

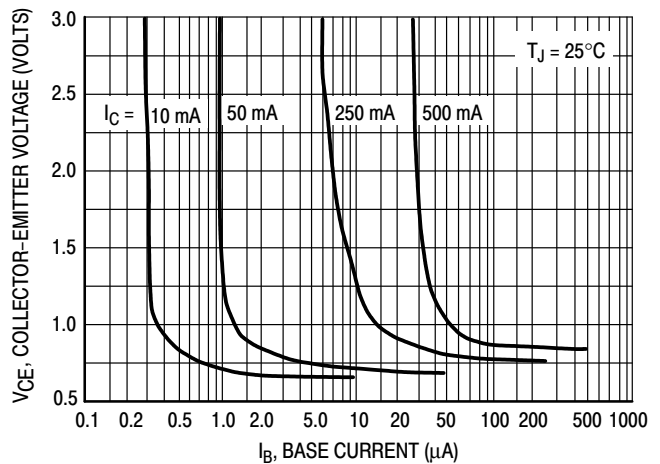

Figure 9. Collector Saturation Region

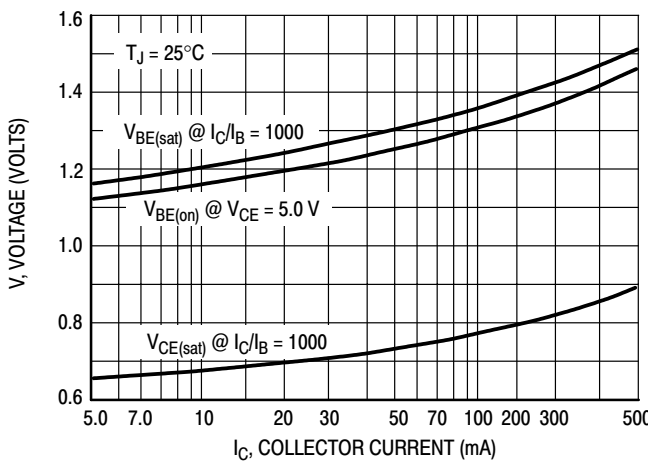

Figure 10. "On" Voltages

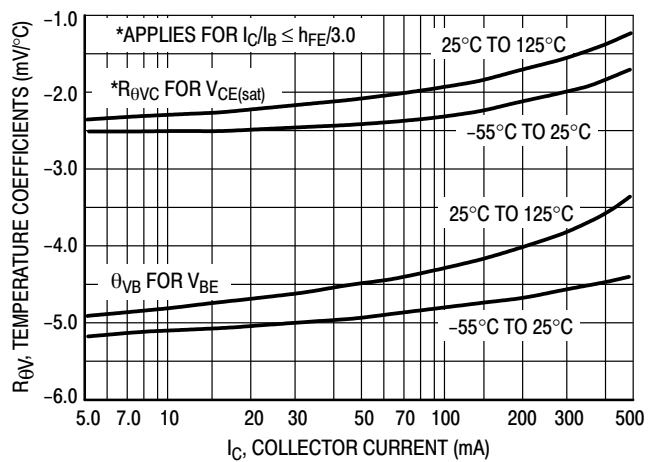

Figure 11. Temperature Coefficients

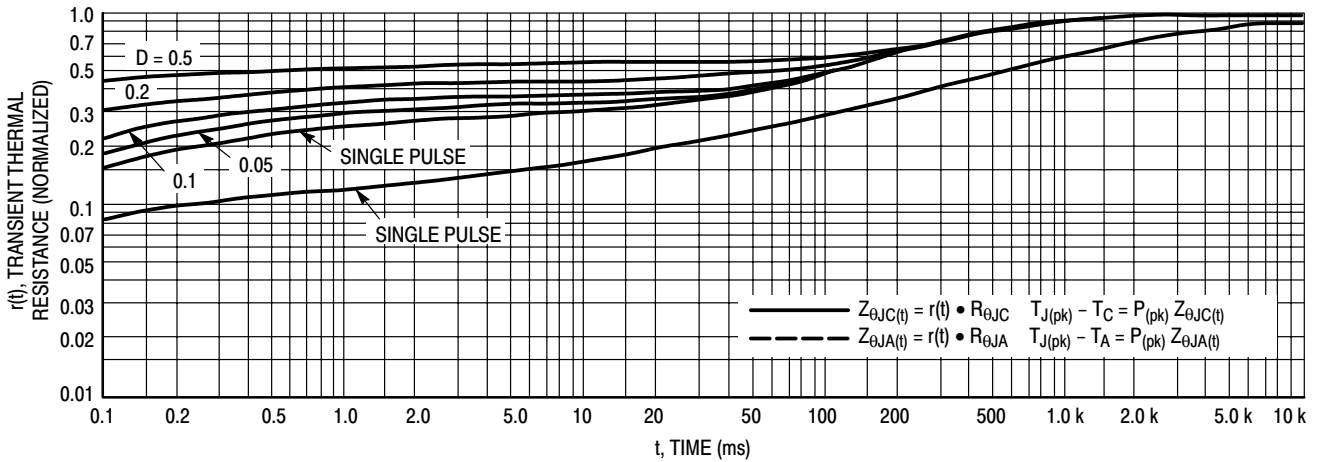

Figure 12. Thermal Response

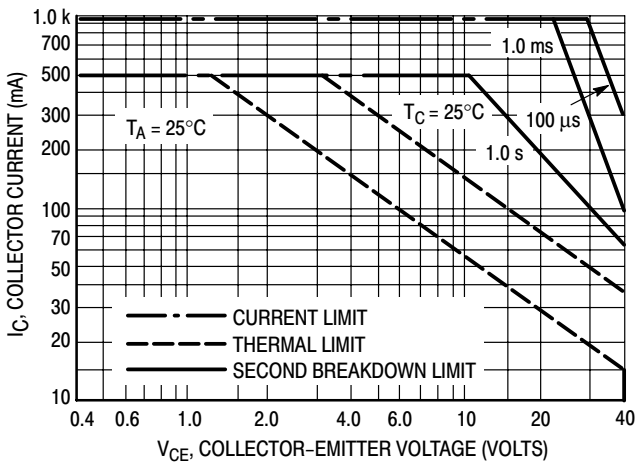
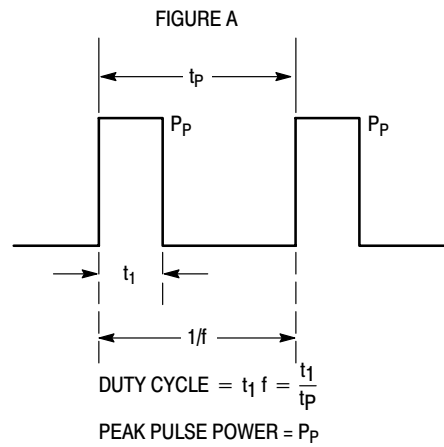

Figure 13. Active Region Safe Operating Area



Design Note: Use of Transient Thermal Resistance Data



Micro Commercial Components

### Ordering Information :

Device	Packing
Part Number-AP	Ammo Packing: 20Kpcs/Carton
Part Number-BP	Bulk: 100Kpcs/Carton

Note : Adding "-HF" suffix for halogen free, eg. Part Number-AP-HF

#### \*\*\*IMPORTANT NOTICE\*\*\*

**Micro Commercial Components Corp.** reserves the right to make changes without further notice to any product herein to make corrections, modifications, enhancements, improvements, or other changes. **Micro Commercial Components Corp.** does not assume any liability arising out of the application or use of any product described herein; neither does it convey any license under its patent rights, nor the rights of others. The user of products in such applications shall assume all risks of such use and will agree to hold **Micro Commercial Components Corp.** and all the companies whose products are represented on our website, harmless against all damages.

#### \*\*\*LIFE SUPPORT\*\*\*

MCC's products are not authorized for use as critical components in life support devices or systems without the express written approval of Micro Commercial Components Corporation.

#### \*\*\*CUSTOMER AWARENESS\*\*\*

Counterfeiting of semiconductor parts is a growing problem in the industry. Micro Commercial Components (MCC) is taking strong measures to protect ourselves and our customers from the proliferation of counterfeit parts. MCC strongly encourages customers to purchase MCC parts either directly from MCC or from Authorized MCC Distributors who are listed by country on our web page cited below. Products customers buy either from MCC directly or from Authorized MCC Distributors are genuine parts, have full traceability, meet MCC's quality standards for handling and storage. **MCC will not provide any warranty coverage or other assistance for parts bought from Unauthorized Sources.** MCC is committed to combat this global problem and encourage our customers to do their part in stopping this practice by buying direct or from authorized distributors.

[www.mccsemi.com](http://www.mccsemi.com)

# Mouser Electronics

Authorized Distributor

Click to View Pricing, Inventory, Delivery & Lifecycle Information:

[Micro Commercial Components \(MCC\):](#)

[MPSA13-AP](#) [MPSA14-AP](#)