



Ultra-Low-Power Voltage Detectors and μ P Supervisory Circuits

MAX6461-MAX6466

General Description

The MAX6461-MAX6466 family of ultra-low-power voltage detectors and μ P reset supervisory circuits monitors battery, power-supply, and system voltages. Each circuit includes a precision bandgap reference, a comparator, internally trimmed resistor networks that set specified trip thresholds, and an internal 5% threshold hysteresis circuit (see the *Functional Diagram*). Output is asserted when V_{CC} falls below the internal V_{TH-} and remains asserted until V_{CC} rises above V_{TH+} ($V_{TH+} = V_{TH-} \times 1.05$). These devices provide excellent circuit reliability and low cost by eliminating external components and adjustments when monitoring nominal system voltages from +1.6V to +5.5V. The MAX6461/MAX6462/MAX6463 are voltage detectors with a propagation delay of 17 μ s.

The MAX6464/MAX6465/MAX6466 are μ P supervisory circuits with a minimum reset timeout period of 150ms. All devices are available with thresholds from +1.6V to +5.5V in 100mV increments.

The family is available with three output stage options: push-pull with active-low output, push-pull with active-high output, and open drain with active-low output. These devices are available in SC70 and SOT23 packages specified over the -40°C to +125°C temperature range.

Applications

- Precision Battery Monitoring
- Load Switching/Power Sequencing
- Power-Supply Monitoring in Digital/Analog Systems
- Noise-Immune μ P Reset Circuits
- Portable/Battery-Powered Equipment
- Cellular Phones/Cordless Phones
- PDA's
- Portable Medical Devices

Features

- ◆ Ultra-Low 1.0 μ A Supply Current
- ◆ Preset Thresholds from +1.6V to +5.5V in 100mV Increments
- ◆ Internal 5% Threshold Hysteresis
- ◆ $\pm 2.5\%$ Threshold Accuracy Over Temperature
- ◆ Internal Timeout Period Option (150ms min)
- ◆ Immune to Short Voltage Transients
- ◆ No External Components
- ◆ Available in Three Output Options: Push-Pull (Active Low/Active High) and Open Drain (Active Low)
- ◆ Fully Specified from -40°C to +125°C
- ◆ Small SC70 and SOT23 Packages

Ordering Information

PART	TEMP RANGE	PIN-PACKAGE
MAX6461XR__-T	-40°C to +125°C	3 SC70-3
MAX6461UR__-T	-40°C to +125°C	3 SOT23-3
MAX6461UK__-T	-40°C to +125°C	5 SOT23-5
MAX6462XR__-T	-40°C to +125°C	3 SC70-3
MAX6462UR__-T	-40°C to +125°C	3 SOT23-3
MAX6462UK__-T	-40°C to +125°C	5 SOT23-5

The MAX6461-MAX6466 are available in factory-set thresholds from 1.6V to 5.5V in approximately 100mV increments. Choose the desired voltage threshold suffix from Table 1 and insert it in the blank spaces in the part number. There are 30 standard versions with a required order increment of 2500 pieces. Sample stock generally is held on the standard versions only (Table 2). Nonstandard versions require a 10k-piece order increment. Contact factory for availability. All devices available in tape-and-reel only.

Devices are available in both leaded and lead-free packaging. Specify lead-free by replacing "-T" with "+T" when ordering.

Ordering Information continued at end of data sheet.
Selector Guide appears at end of data sheet.

Pin Configurations



Ultra-Low-Power Voltage Detectors and μ P Supervisory Circuits

ABSOLUTE MAXIMUM RATINGS

(All voltages referenced to GND unless otherwise noted.)

V_{CC}, Open-Drain OUT-0.3V to +7V

Push-Pull OUT/ $\overline{\text{OUT}}$ -0.3V to (V_{CC} + 0.3V)

Input/Output Current (all pins)20mA

Output Short Circuit (V_{CC} or GND)

Continuous Power Dissipation (T_A = +70°C)

3-Pin SC70 (derate 2.9mW/°C above +70°C)228.6mW

3-Pin SOT23 (derate 4.0mW/°C above +70°C)320mW

5-Pin SOT23 (derate 7.1mW/°C above +70°C)571mW

Operating Temperature Range-40°C to +125°C

Junction Temperature+150°C

Storage Temperature Range-65°C to +150°C

Lead Temperature (soldering, 10s)+300°C

Stresses beyond those listed under "Absolute Maximum Ratings" may cause permanent damage to the device. These are stress ratings only, and functional operation of the device at these or any other conditions beyond those indicated in the operational sections of the specifications is not implied. Exposure to absolute maximum rating conditions for extended periods may affect device reliability.

ELECTRICAL CHARACTERISTICS

(V_{CC} = +1.2V to +6V, T_A = -40°C to +125°C. Typical values are at T_A = +25°C, unless otherwise noted.) (Note1)

PARAMETER	SYMBOL	CONDITIONS	MIN	TYP	MAX	UNITS
Operating Voltage Range	V _{CC}	T _A = 0°C to +125°C	1		6	V
		T _A = -40°C to 0°C	1.2		6.0	
V _{CC} Supply Current	I _{CC}	V _{CC} = 3.6V, T _A = -40°C to +125°C, no load, output not asserted		1	2	μ A
		V _{CC} = 5.0V, T _A = -40°C to +85°C, no load, output not asserted		1.3	2.5	
		V _{CC} = 5.0V, T _A = +85°C to +125°C, no load, output not asserted				
Voltage Threshold (Note 2)	V _{TH+}	V _{CC} rising, T _A = +25°C	(V _{TH+}) \times 0.985	V _{TH+}	(V _{TH+}) \times 1.015	V
		V _{CC} rising, T _A = -40°C to +125°C	(V _{TH+}) \times 0.975		(V _{TH+}) \times 1.025	
	V _{TH-}	V _{CC} falling, T _A = +25°C	(V _{TH-}) \times 0.985	V _{TH-}	(V _{TH-}) \times 1.015	
		V _{CC} falling, T _A = -40°C to +125°C	(V _{TH-}) \times 0.975		(V _{TH-}) \times 1.025	
Voltage Threshold Hysteresis	V _{HYST}	V _{HYST} = [(V _{TH+}) - (V _{TH-})] / (V _{TH-}) \times 100%	3	4.5	6	%
Propagation Delay	t _P	V _{CC} falling at 10mV/ μ s from (V _{TH-}) + 100mV to (V _{TH-}) - 100mV		17		μ s
		V _{CC} rising at 10mV/ μ s from (V _{TH+}) - 100mV to (V _{TH+}) + 100mV	MAX6461/ MAX6462/ MAX6463 only		100	
Startup Time (MAX6461/MAX6462/MAX6463)				225		μ s
Output Timeout Period (MAX6464/MAX6465/MAX6466)	t _{RP}		150	260	430	ms

Ultra-Low-Power Voltage Detectors and μP Supervisory Circuits

MAX6461-MAX6466

ELECTRICAL CHARACTERISTICS (continued)

($V_{CC} = +1.2\text{V}$ to $+6\text{V}$, $T_A = -40^\circ\text{C}$ to $+125^\circ\text{C}$. Typical values are at $T_A = +25^\circ\text{C}$, unless otherwise noted.) (Note 1)

PARAMETER	SYMBOL	CONDITIONS	MIN	TYP	MAX	UNITS
$\overline{\text{OUT}}$ Output Low (Open Drain or Push-Pull)	V_{OL}	$V_{CC} \geq 1.2\text{V}$, $I_{\text{SINK}} = 1.0\text{mA}$, $\overline{\text{OUT}}$ asserted			0.3	V
		$V_{CC} \geq 2.5\text{V}$, $I_{\text{SINK}} = 4.0\text{mA}$, $\overline{\text{OUT}}$ asserted			0.3	
		$V_{CC} \geq 4.5\text{V}$, $I_{\text{SINK}} = 9.0\text{mA}$, $\overline{\text{OUT}}$ asserted			0.4	
$\overline{\text{OUT}}$ Output High (Push-Pull)	V_{OH}	$V_{CC} \geq 1.8\text{V}$, $I_{\text{SOURCE}} = 1.5\text{mA}$, $\overline{\text{OUT}}$ not asserted	$0.8 \times V_{CC}$			V
		$V_{CC} \geq 2.5\text{V}$, $I_{\text{SOURCE}} = 3.0\text{mA}$, $\overline{\text{OUT}}$ not asserted	$0.8 \times V_{CC}$			
		$V_{CC} \geq 4.5\text{V}$, $I_{\text{SOURCE}} = 8.0\text{mA}$, $\overline{\text{OUT}}$ not asserted	$0.8 \times V_{CC}$			
$\overline{\text{OUT}}$ Output Open-Drain Leakage Current	I_{LKG}	$\overline{\text{OUT}}$ not asserted, $V_{\overline{\text{OUT}}} = +6\text{V}$			100	nA
OUT Output High (Push-Pull)	V_{OH}	$V_{CC} \geq 1.2\text{V}$, $I_{\text{SOURCE}} = 200\mu\text{A}$, OUT asserted	$0.8 \times V_{CC}$			V
		$V_{CC} \geq 1.8\text{V}$, $I_{\text{SOURCE}} = 1.5\text{mA}$, OUT asserted	$0.8 \times V_{CC}$			
		$V_{CC} \geq 2.5\text{V}$, $I_{\text{SOURCE}} = 3.0\text{mA}$, OUT asserted	$0.8 \times V_{CC}$			
		$V_{CC} \geq 4.5\text{V}$, $I_{\text{SOURCE}} = 8.0\text{mA}$, OUT asserted	$0.8 \times V_{CC}$			
OUT Output Low (Push-Pull)	V_{OL}	$V_{CC} \geq 2.5\text{V}$, $I_{\text{SINK}} = 4.0\text{mA}$, OUT not asserted			0.3	V
		$V_{CC} \geq 4.5\text{V}$, $I_{\text{SINK}} = 9.0\text{mA}$, OUT not asserted			0.4	

Note 1: 100% production testing done at $+25^\circ\text{C}$. Limits over temperature are guaranteed by design.

Note 2: See Table 1 for $V_{\text{TH-}}$ and $V_{\text{TH+}}$ values.

Typical Operating Characteristics

($V_{CC} = 5\text{V}$, $T_A = +25^\circ\text{C}$, unless otherwise noted.)

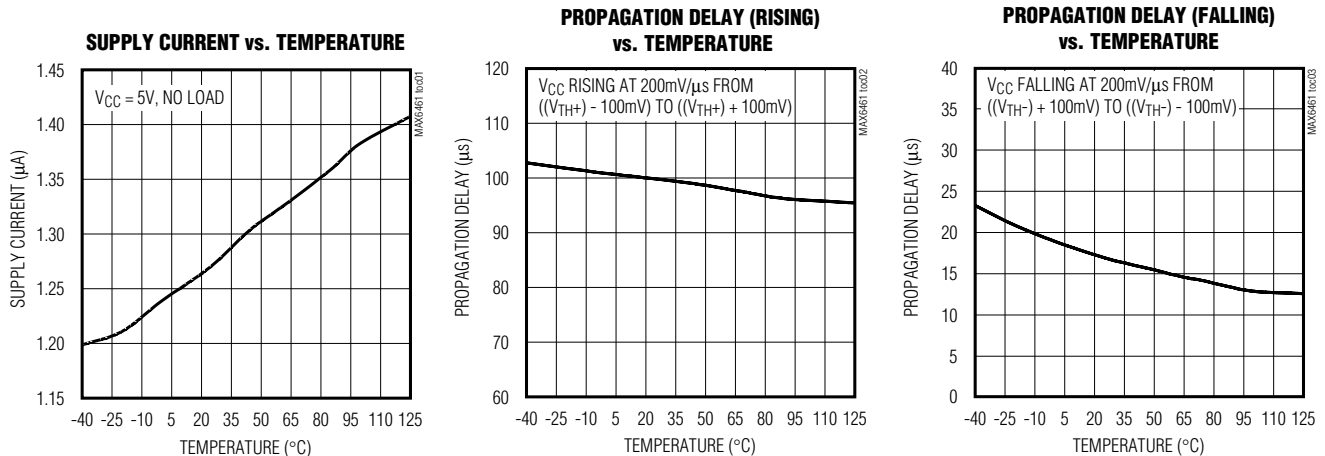

Ultra-Low-Power Voltage Detectors and μ P Supervisory Circuits

Typical Operating Characteristics (continued)

($V_{CC} = 5V$, $T_A = +25^\circ C$, unless otherwise noted.)

MAXIMUM V_{CC} TRANSIENT DURATION vs. V_{TH} THRESHOLD OVERDRIVE

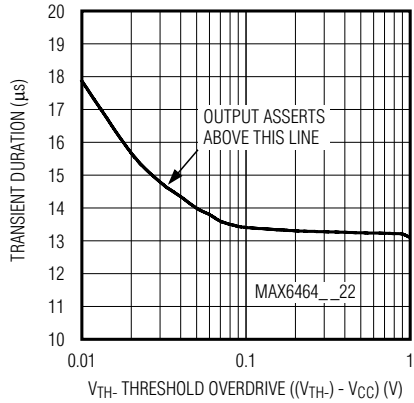

PROPAGATION DELAY V_{CC} RISING

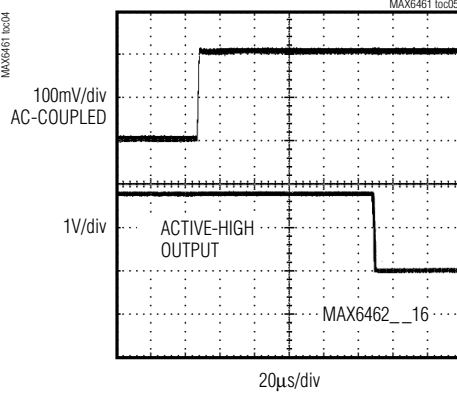

PROPAGATION DELAY V_{CC} FALLING

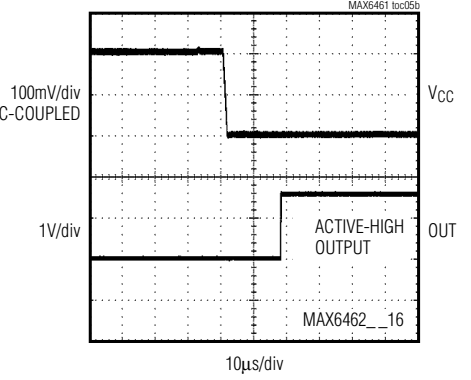

OUTPUT VOLTAGE HIGH vs. SOURCE CURRENT

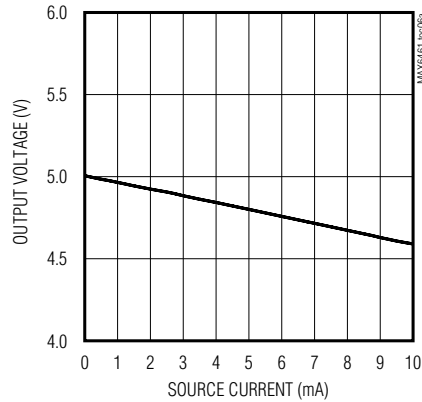

OUTPUT VOLTAGE HIGH vs. SOURCE CURRENT

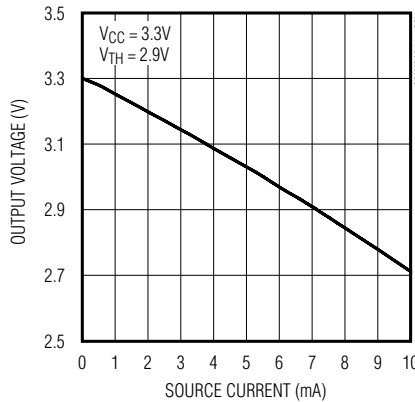

OUTPUT VOLTAGE LOW vs. SINK CURRENT

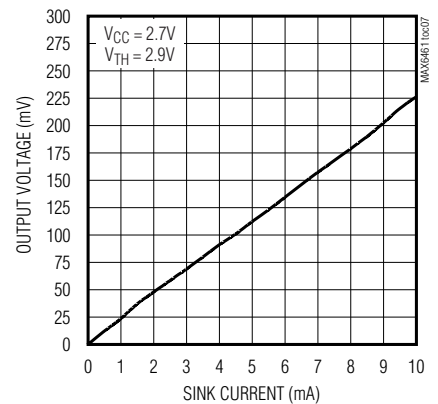

NORMALIZED THRESHOLD vs. TEMPERATURE



NORMALIZED OUTPUT TIMEOUT PERIOD vs. TEMPERATURE

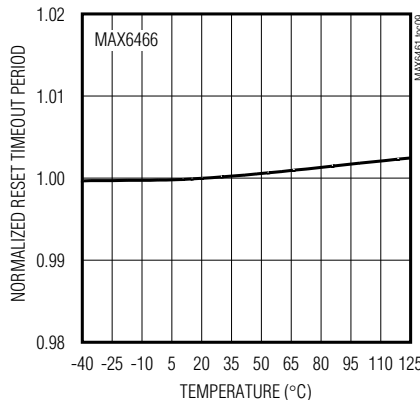

HYSTERESIS vs. TEMPERATURE

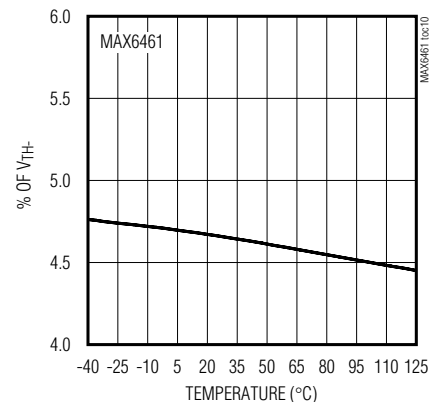

Ultra-Low-Power Voltage Detectors and μP Supervisory Circuits

Pin Description

MAX6461-MAX6466

PIN			NAME	FUNCTION
MAX6461-MAX6466				
SOT23-3	SC70-3	SOT23-5		
1	2	4	$\overline{\text{OUT}}$	Detector Output for the MAX6461/MAX6462/MAX6463: Push-pull (active-low or active-high) and open-drain (active-low) options. $\overline{\text{OUT}}$ is asserted low when the monitored input (V_{CC}) drops below the internal $V_{\text{TH-}}$ threshold and remains low until the monitored input exceeds the internal $V_{\text{TH+}}$ threshold. $\overline{\text{OUT}}$ is asserted high when the monitored input (V_{CC}) drops below the internal $V_{\text{TH-}}$ threshold and remains high until the monitored input exceeds the internal $V_{\text{TH+}}$ threshold. The open-drain output $\overline{\text{OUT}}$ requires an external pullup resistor. Output for the MAX6464/MAX6465/MAX6466: Push-pull (active-low or active-high) and open-drain (active-low) options.
			OUT	$\overline{\text{OUT}}$ is asserted low when the monitored input (V_{CC}) drops below the internal $V_{\text{TH-}}$ threshold and remains low for at least 150ms after the monitored input exceeds the internal $V_{\text{TH+}}$ threshold. OUT is asserted high when the monitored input (V_{CC}) drops below the internal $V_{\text{TH-}}$ threshold and remains high for at least 150ms after the monitored input exceeds the internal $V_{\text{TH+}}$ threshold. The open-drain output $\overline{\text{OUT}}$ requires an external pullup resistor.
2	1	2, 3	GND	Ground. In the SOT23-5 package, both pins must be grounded.
3	3	5	V_{CC}	Supply Voltage and Monitored Voltage Input
—	—	1	N.C.	No Connection

Functional Diagram

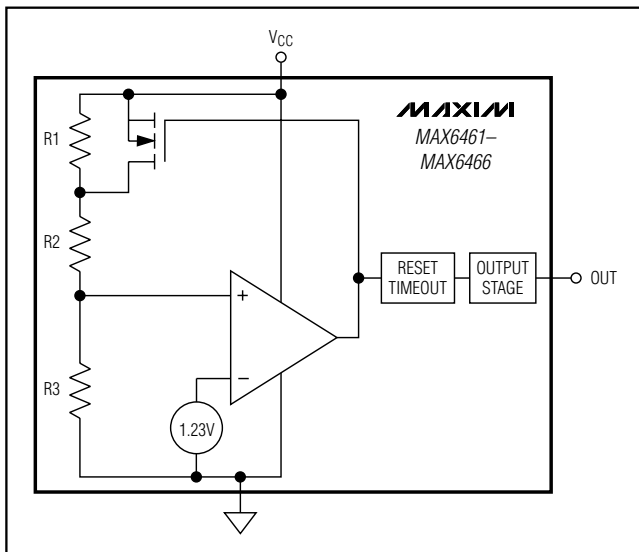

Detailed Description

The MAX6461/MAX6462/MAX6463 voltage detectors and the MAX6464/MAX6465/MAX6466 μP reset supervisory circuits monitor battery, power-supply, and system voltages from +1.6V to +5.5V. These devices consume only 1 μA of supply current with a 3.6V supply voltage. Whenever V_{CC} falls below the internal $V_{\text{TH-}}$ threshold, the output is asserted and remains asserted until V_{CC} rises above $V_{\text{TH+}}$ ($V_{\text{TH+}} = V_{\text{TH-}} \times 1.05$). All devices have $\pm 2.5\%$ threshold accuracy over temperature and offer protection to short voltage transients. These devices are ideal for low-cost and space-critical applications because they do not require external components for proper operation.

Ultra-Low-Power Voltage Detectors and μP Supervisory Circuits



Figure 1. Interfacing to Different Logic Voltage Components

Applications Information

Interfacing to Different Logic Voltage Components

The MAX6463 and MAX6466's active-low, open-drain output versions can be used to interface with a different logic voltage than V_{CC} , as shown in Figure 1. This output structure sinks current when $\overline{\text{OUT}}$ is asserted. Connect a pullup resistor from $\overline{\text{OUT}}$ to any supply from 0 to 6V. Select a resistor value large enough to allow a valid logic low (see the *Electrical Characteristics*) and small enough to register a logic high while supplying all input current and leakage paths connected to the $\overline{\text{OUT}}$ pin.

Hysteresis

The MAX6461–MAX6466 feature internal hysteresis that creates two trip points: one for rising supply voltage and one for falling supply voltage. The hysteresis prevents the output from oscillating (chattering) when V_{CC} is near the voltage threshold.

Transients Immunity

These devices are relatively immune to short-duration and falling V_{CC} transients (glitches). The *Typical Operating Characteristics* show the Maximum Transient Duration vs. Threshold Overdrive graph, for which $\overline{\text{OUT}}$ is not asserted. The graph shows the maximum pulse width that a falling V_{CC} transient typically might have before the devices are asserted. As the amplitude of the transient increases, the maximum allowable pulse width decreases.

Ensuring Valid Output Down to 0V

When V_{CC} falls below 1V, the MAX6461/MAX6464 output sinking capability is reduced. Therefore, high-impedance CMOS logic inputs connected to $\overline{\text{OUT}}$ can drift to undetermined voltages. This presents no problem in most applications, because most circuitry is inoperative when V_{CC} is below 1V. In applications where $\overline{\text{OUT}}$ must be valid down to ground, add a pull-down resistor to ground so any stray leakage currents flow to ground, holding $\overline{\text{OUT}}$ low. Select a resistor large enough not to load $\overline{\text{OUT}}$ and small enough to pull $\overline{\text{OUT}}$ to ground. For most applications, 100k Ω does not load $\overline{\text{OUT}}$ and pulls $\overline{\text{OUT}}$ to ground.

Ultra-Low-Power Voltage Detectors and μ P Supervisory Circuits

MAX6461-MAX6466

Table 1a. MAX6461-MAX6466 Lower Trip Threshold (V_{TH-}) Voltage Options

SUFFIX	VOLTAGE THRESHOLD, V_{TH-}				
	$T_A = +25^\circ\text{C}$			$T_A = -40^\circ\text{C to } +125^\circ\text{C}$	
	V_{TH-} (min)	V_{TH-} (typ)	V_{TH-} (max)	V_{TH-} (min)	V_{TH-} (max)
16	1.576	1.600	1.624	1.560	1.640
17	1.675	1.700	1.726	1.658	1.743
18	1.773	1.800	1.827	1.755	1.845
19	1.872	1.900	1.929	1.853	1.948
20	1.970	2.000	2.030	1.950	2.050
21	2.069	2.100	2.132	2.048	2.153
22	2.167	2.200	2.233	2.145	2.255
23	2.266	2.300	2.335	2.243	2.358
24	2.364	2.400	2.436	2.340	2.460
25	2.463	2.500	2.538	2.438	2.563
26	2.561	2.600	2.639	2.535	2.665
27	2.660	2.700	2.741	2.633	2.768
28	2.758	2.800	2.842	2.730	2.870
29	2.857	2.900	2.944	2.828	2.973
30	2.955	3.000	3.045	2.925	3.075
31	3.054	3.100	3.147	3.023	3.178
32	3.152	3.200	3.248	3.120	3.280
33	3.251	3.300	3.350	3.218	3.383
34	3.349	3.400	3.451	3.315	3.485
35	3.448	3.500	3.553	3.413	3.588
36	3.546	3.600	3.654	3.510	3.690
37	3.645	3.700	3.756	3.608	3.793
38	3.743	3.800	3.857	3.705	3.895
39	3.842	3.900	3.959	3.803	3.998
40	3.940	4.000	4.060	3.900	4.100
41	4.039	4.100	4.162	3.998	4.203
42	4.137	4.200	4.263	4.095	4.305
43	4.236	4.300	4.365	4.193	4.408
44	4.334	4.400	4.466	4.290	4.510
45	4.433	4.500	4.568	4.388	4.613
46	4.531	4.600	4.669	4.485	4.715
47	4.630	4.700	4.771	4.583	4.818
48	4.728	4.800	4.872	4.680	4.920
49	4.827	4.900	4.974	4.778	5.023
50	4.925	5.000	5.075	4.875	5.125
51	5.024	5.100	5.177	4.973	5.228
52	5.122	5.200	5.278	5.070	5.330
53	5.221	5.300	5.380	5.168	5.433
54	5.319	5.400	5.481	5.265	5.535
55	5.418	5.500	5.583	5.363	5.638

Ultra-Low-Power Voltage Detectors and μ P Supervisory Circuits

Table 1b. MAX6461–MAX6466 Upper Trip Threshold (V_{TH+}) Voltage Options

SUFFIX	VOLTAGE THRESHOLD, V_{TH+}				
	$T_A = +25^\circ\text{C}$			$T_A = -40^\circ\text{C to } +125^\circ\text{C}$	
	V_{TH+} (min)	V_{TH+} (typ)	V_{TH+} (max)	V_{TH+} (min)	V_{TH+} (max)
16	1.647	1.672	1.697	1.630	1.714
17	1.750	1.777	1.803	1.732	1.821
18	1.853	1.881	1.909	1.834	1.928
19	1.956	1.986	2.015	1.936	2.035
20	2.059	2.090	2.121	2.038	2.142
21	2.162	2.195	2.227	2.140	2.249
22	2.265	2.299	2.333	2.242	2.356
23	2.367	2.404	2.440	2.343	2.464
24	2.470	2.508	2.546	2.445	2.571
25	2.573	2.613	2.652	2.547	2.678
26	2.676	2.717	2.758	2.649	2.785
27	2.779	2.822	2.864	2.751	2.892
28	2.882	2.926	2.970	2.853	2.999
29	2.985	3.031	3.076	2.955	3.106
30	3.088	3.135	3.182	3.057	3.213
31	3.191	3.240	3.288	3.159	3.320
32	3.294	3.344	3.394	3.260	3.428
33	3.397	3.449	3.500	3.362	3.535
34	3.500	3.553	3.606	3.464	3.642
35	3.603	3.658	3.712	3.566	3.749
36	3.706	3.762	3.818	3.668	3.856
37	3.809	3.867	3.924	3.770	3.963
38	3.911	3.971	4.031	3.872	4.070
39	4.014	4.076	4.137	3.974	4.177
40	4.117	4.180	4.243	4.076	4.285
41	4.220	4.285	4.349	4.177	4.392
42	4.323	4.389	4.455	4.279	4.499
43	4.426	4.494	4.561	4.381	4.606
44	4.529	4.598	4.667	4.483	4.713
45	4.632	4.703	4.773	4.585	4.820
46	4.735	4.807	4.879	4.687	4.927
47	4.838	4.912	4.985	4.789	5.034
48	4.941	5.016	5.091	4.891	5.141
49	5.044	5.121	5.197	4.992	5.249
50	5.147	5.225	5.303	5.094	5.356
51	5.250	5.330	5.409	5.196	5.463
52	5.352	5.434	5.516	5.298	5.570
53	5.455	5.539	5.622	5.400	5.677
54	5.558	5.643	5.728	5.502	5.784
55	5.661	5.748	5.834	5.604	5.891

Ultra-Low-Power Voltage Detectors and μ P Supervisory Circuits

MAX6461-MAX6466

Table 2. Standard Versions Table

PART	TOP MARK (SC70)
MAX6461 XR16-T	AMB
MAX6461XR22-T	AMC
MAX6461XR26-T	AMD
MAX6461XR29-T	AKV
MAX6461XR46-T	AME
MAX6462 XR16-T	AKW
MAX6462XR22-T	AMF
MAX6462XR26-T	AMG
MAX6462XR29-T	AMH
MAX6462XR46-T	AMI
MAX6463 XR16-T	AMJ
MAX6463XR22-T	AMK
MAX6463XR26-T	AML
MAX6463XR29-T	AMM
MAX6463XR46-T	AMN

PART	TOP MARK (SC70)
MAX6464 XR16-T	AMO
MAX6464XR22-T	AMP
MAX6464XR26-T	AMQ
MAX6464XR29-T	AMR
MAX6464XR46-T	AMS
MAX6465 XR16-T	AMT
MAX6465XR22-T	AMU
MAX6465XR26-T	AMV
MAX6465XR29-T	AMW
MAX6465XR46-T	AKZ
MAX6466 XR16-T	AMX
MAX6466XR22-T	AMY
MAX6466XR26-T	AMZ
MAX6466XR29-T	ALA
MAX6466XR46-T	ALB

Selector Guide

PART	PUSH-PULL OUT	PUSH-PULL OUT	OPEN-DRAIN OUT	TYPICAL PROPAGATION DELAY (μ s)	MINIMUM TIMEOUT PERIOD (ms)
MAX6461	✓	—	—	14	—
MAX6462	—	✓	—	14	—
MAX6463	—	—	✓	14	—
MAX6464	✓	—	—	—	150
MAX6465	—	✓	—	—	150
MAX6466	—	—	✓	—	150

Ultra-Low-Power Voltage Detectors and μ P Supervisory Circuits

Ordering Information (continued)

PART	TEMP RANGE	PIN-PACKAGE
MAX6463 XR_ _-T	-40°C to +125°C	3 SC70-3
MAX6463UR_ _-T	-40°C to +125°C	3 SOT23-3
MAX6463UK_ _-T	-40°C to +125°C	5 SOT23-5
MAX6464 XR_ _-T	-40°C to +125°C	3 SC70-3
MAX6464UR_ _-T	-40°C to +125°C	3 SOT23-3
MAX6464UK_ _-T	-40°C to +125°C	5 SOT23-5
MAX6465 XR_ _-T	-40°C to +125°C	3 SC70-3
MAX6465UR_ _-T	-40°C to +125°C	3 SOT23-3
MAX6465UK_ _-T	-40°C to +125°C	5 SOT23-5
MAX6466 XR_ _-T	-40°C to +125°C	3 SC70-3
MAX6466UR_ _-T	-40°C to +125°C	3 SOT23-3
MAX6466UK_ _-T	-40°C to +125°C	5 SOT23-5

The MAX6461-MAX6466 are available in factory-set thresholds from 1.6V to 5.5V in approximately 100mV increments. Choose the desired voltage threshold suffix from Table 1 and insert it in the blank spaces in the part number. There are 30 standard versions with a required order increment of 2500 pieces. Sample stock generally is held on the standard versions only (Table 2). Nonstandard versions require a 10k-piece order increment. Contact factory for availability. All devices available in tape-and-reel only.

Devices are available in both leaded and lead-free packaging. Specify lead-free by replacing "-T" with "+T" when ordering.

Chip Information

TRANSISTOR COUNT: 581
PROCESS: BICMOS

Package Information

For the latest package outline information, go to www.maxim-ic.com/packages.)

Maxim cannot assume responsibility for use of any circuitry other than circuitry entirely embodied in a Maxim product. No circuit patent licenses are implied. Maxim reserves the right to change the circuitry and specifications without notice at any time.

10 **Maxim Integrated Products, 120 San Gabriel Drive, Sunnyvale, CA 94086 408-737-7600**

Mouser Electronics

Authorized Distributor

Click to View Pricing, Inventory, Delivery & Lifecycle Information:

Maxim Integrated:

[MAX6462UK23+T](#) [MAX6462UK24+T](#) [MAX6462UK25+T](#) [MAX6462UK26+T](#) [MAX6462UK27+T](#) [MAX6462UK28+T](#)
[MAX6462UK29+T](#) [MAX6462UK30+T](#) [MAX6462UK31+T](#) [MAX6462UK32+T](#) [MAX6462UK33+T](#) [MAX6462UK34+T](#)
[MAX6462UK35+T](#) [MAX6462UK36+T](#) [MAX6462UK37+T](#) [MAX6462UK38+T](#) [MAX6462UK39+T](#) [MAX6462UK40+T](#)
[MAX6462UK41+T](#) [MAX6462UK42+T](#) [MAX6462UK43+T](#) [MAX6462UK44+T](#) [MAX6462UK45+T](#) [MAX6462UK46+T](#)
[MAX6462UK47+T](#) [MAX6462UK48+T](#) [MAX6462UK49+T](#) [MAX6462UK50+T](#) [MAX6462UK51+T](#) [MAX6462UK52+T](#)
[MAX6462UK53+T](#) [MAX6462UK54+T](#) [MAX6462UK55+T](#) [MAX6462UR16+T](#) [MAX6462UR17+T](#) [MAX6462UR18+T](#)
[MAX6462UR19+T](#) [MAX6462UR20+T](#) [MAX6462UR21+T](#) [MAX6462UR22+T](#) [MAX6462UR23+T](#) [MAX6462UR24+T](#)
[MAX6462UR25+T](#) [MAX6462UR26+T](#) [MAX6462UR27+T](#) [MAX6462UR28+T](#) [MAX6462UR29+T](#) [MAX6462UR30+T](#)
[MAX6462UR31+T](#) [MAX6462UR32+T](#) [MAX6462UR33+T](#) [MAX6462UR34+T](#) [MAX6462UR35+T](#) [MAX6462UR36+T](#)
[MAX6462UR37+T](#) [MAX6462UR38+T](#) [MAX6462UR39+T](#) [MAX6462UR40+T](#) [MAX6462UR41+T](#) [MAX6462UR42+T](#)
[MAX6462UR43+T](#) [MAX6462UR44+T](#) [MAX6462UR45+T](#) [MAX6462UR46+T](#) [MAX6462UR47+T](#) [MAX6462UR48+T](#)
[MAX6462UR49+T](#) [MAX6462UR50+T](#) [MAX6462UR51+T](#) [MAX6462UR52+T](#) [MAX6462UR53+T](#) [MAX6462UR54+T](#)
[MAX6462UR55+T](#) [MAX6462XR16+T](#) [MAX6462XR17+T](#) [MAX6462XR18+T](#) [MAX6462XR19+T](#) [MAX6462XR20+T](#)
[MAX6462XR21+T](#) [MAX6462XR22+T](#) [MAX6462XR23+T](#) [MAX6462XR24+T](#) [MAX6462XR25+T](#) [MAX6462XR26+T](#)
[MAX6462XR27+T](#) [MAX6462XR28+T](#) [MAX6462XR29+T](#) [MAX6462XR30+T](#) [MAX6462XR31+T](#) [MAX6462XR32+T](#)
[MAX6462XR33+T](#) [MAX6462XR34+T](#) [MAX6462XR35+T](#) [MAX6462XR36+T](#) [MAX6462XR37+T](#) [MAX6462XR38+T](#)
[MAX6462XR39+T](#) [MAX6462XR40+T](#) [MAX6462XR41+T](#) [MAX6462XR42+T](#)