



# Low-Noise, Precision, +2.5V/+4.096V/+5V Voltage Reference

MAX6220

## General Description

The MAX6220 is a low-noise, precision voltage reference with extremely low 20ppm/°C temperature coefficient over the automotive temperature range (-40°C to +125°C) and excellent ±0.1% initial accuracy. This device features buried-zener technology for low noise performance. The load-regulation specification is guaranteed for source and sink currents up to 15mA. Excellent line and load regulation and low output impedance at high frequency make the MAX6220 ideal for high-resolution data-conversion systems up to 16 bits. The MAX6220 is set for 2.5V, 4.096V, and 5.0V outputs.

## Features

- ◆ Low 20ppm/°C Temperature Coefficient over -40°C to +125°C Range
- ◆ Very Low 1.5µVp-p Noise (0.1Hz to 10Hz)
- ◆ ±0.1% Initial Accuracy
- ◆ ±15mA Output Source and Sink Current
- ◆ 8V to 40V Input Voltage Range
- ◆ Optional Noise Reduction and Voltage Trim
- ◆ Excellent Transient Response
- ◆ Low 20ppm/1000hr Long-Term Stability
- ◆ Stable for All Capacitive Loads

## Applications

High-Accuracy Industrial and Process Control  
 ATE Equipment  
 Precision Current Sources

## Ordering Information

PART	TEMP. RANGE	PIN-PACKAGE	OUTPUT VOLTAGE (V)
MAX6220ASA25	-40°C to +125°C	8 SO	2.5
MAX6220ASA41	-40°C to +125°C	8 SO	4.096
MAX6220ASA50	-40°C to +125°C	8 SO	5.0

## Typical Operating Circuit

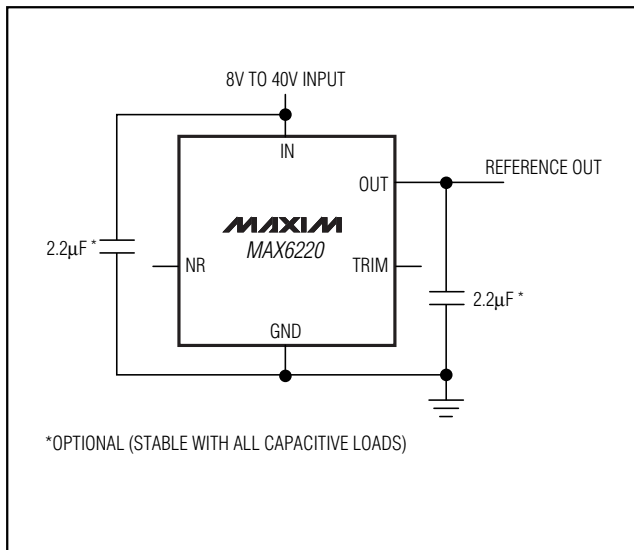

## Pin Configuration

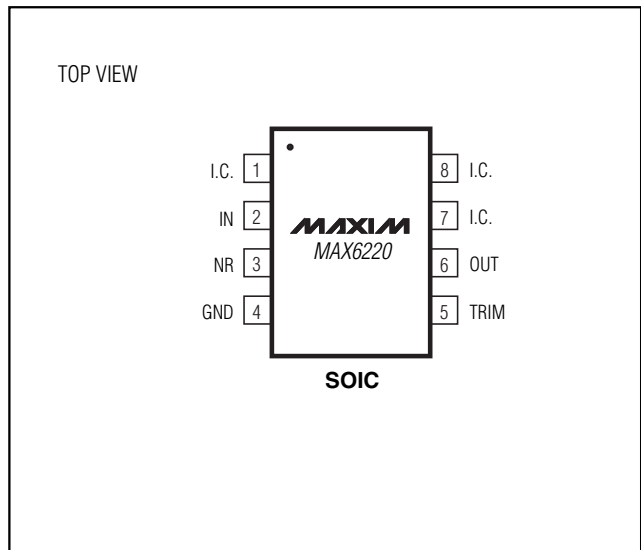

# Low-Noise, Precision, +2.5V/+4.096V/+5V Voltage Reference

## ABSOLUTE MAXIMUM RATINGS

(Voltages Referenced to GND)

IN	-0.3V to +42V
OUT, TRIM	-0.3V to +12V
NR	-0.3V to +6V
OUT Short-Circuit to GND Duration ( $V_{IN} \leq 12V$ )	Continuous
OUT Short-Circuit to GND Duration ( $V_{IN} \leq 42V$ )	5s
OUT Short-Circuit to IN Duration ( $V_{IN} \leq 12V$ )	Continuous

Continuous Power Dissipation ( $T_A = +70^\circ\text{C}$ )

8-Pin SO (derate 5.9mW/ $^\circ\text{C}$ above $+70^\circ\text{C}$ )	471mW
Operating Temperature Range	$-40^\circ\text{C}$ to $+125^\circ\text{C}$
Storage Temperature Range	$-65^\circ\text{C}$ to $+150^\circ\text{C}$
Lead Temperature (soldering, 10s)	$+300^\circ\text{C}$

Stresses beyond those listed under "Absolute Maximum Ratings" may cause permanent damage to the device. These are stress ratings only, and functional operation of the device at these or any other conditions beyond those indicated in the operational sections of the specifications is not implied. Exposure to absolute maximum rating conditions for extended periods may affect device reliability.

## ELECTRICAL CHARACTERISTICS—(+2.5V)

( $V_{IN} = +10V$ ,  $I_{OUT} = 0\text{mA}$ ,  $T_A = T_{MIN}$  to  $T_{MAX}$ , unless otherwise noted. Typical values are at  $T_A = +25^\circ\text{C}$ .)

PARAMETER	SYMBOL	CONDITIONS	$T_A$	MIN	TYP	MAX	UNITS
Input Voltage Range	$V_{IN}$			8		40	V
Output Voltage	$V_{OUT}$		$+25^\circ\text{C}$	2.497	2.500	2.503	V
Output Voltage Temperature Coefficient (Note 1)	$TCV_{OUT}$				2	20	ppm/ $^\circ\text{C}$
Line Regulation (Note 2)	$\frac{\Delta V_{OUT}}{\Delta V_{IN}}$	$8V \leq V_{IN} \leq 40V$	$+25^\circ\text{C}$		2	7	ppm/V
						45	
Load Regulation (Note 2)	$\frac{\Delta V_{OUT}}{\Delta I_{OUT}}$	Sourcing: $0\text{mA} \leq I_{OUT} \leq 15\text{mA}$	$+25^\circ\text{C}$		1	6	ppm/mA
						15	
		Sinking: $-15\text{mA} \leq I_{OUT} \leq 0\text{mA}$	$+25^\circ\text{C}$		1	6	
Supply Current	$I_{IN}$		$+25^\circ\text{C}$		1.8	2.9	mA
						3.3	
Trim-Adjustment Range	$\Delta V_{OUT}$	(Figure 1)		$\pm 15$	$\pm 25$		mV
Turn-On Settling Time	$t_{ON}$	To $\pm 0.01\%$ of final value			5		$\mu\text{s}$
Output Noise Voltage (Note 3)	$e_N$	$0.1\text{Hz} \leq f \leq 10\text{Hz}$			1.5		$\mu\text{V}_{p-p}$
		$10\text{Hz} \leq f \leq 1\text{kHz}$			1.3	2.8	$\mu\text{V}_{RMS}$
Temperature Hysteresis		(Note 4)			20		ppm
Long-Term Stability	$\Delta V_{OUT}$	$\Delta t = 1000\text{hr}$			20		ppm

# Low-Noise, Precision, +2.5V/+4.096V/+5V Voltage Reference

**MAX6220**

## ELECTRICAL CHARACTERISTICS—(+4.096V)

( $V_{IN} = +10V$ ,  $I_{OUT} = 0mA$ ,  $T_A = T_{MIN}$  to  $T_{MAX}$ , unless otherwise noted. Typical values are at  $T_A = +25^{\circ}C$ .)

PARAMETER	SYMBOL	CONDITIONS	$T_A$	MIN	TYP	MAX	UNITS
Input Voltage Range	$V_{IN}$			8		40	V
Output Voltage	$V_{OUT}$		+25°C	4.092	4.096	4.100	V
Output Voltage Temperature Coefficient (Note 1)	$TCV_{OUT}$				2	20	ppm/°C
Line Regulation (Note 2)	$\frac{\Delta V_{OUT}}{\Delta V_{IN}}$	$8V \leq V_{IN} \leq 40V$	+25°C		2	7	ppm/V
						45	
Load Regulation (Note 2)	$\frac{\Delta V_{OUT}}{\Delta I_{OUT}}$	Sourcing: $0mA \leq I_{OUT} \leq 15mA$	+25°C		1	6	ppm/mA
						15	
		Sinking: $-15mA \leq I_{OUT} \leq 0mA$	+25°C		1	6	
						30	
Supply Current	$I_{IN}$		+25°C		1.9	3.1	mA
						3.5	
Trim-Adjustment Range	$\Delta V_{OUT}$	(Figure 1)		±24	±40		mV
Turn-On Settling Time	$t_{ON}$	To ±0.01% of final value			5		µs
Output Noise Voltage (Note 3)	$e_N$	$0.1Hz \leq f \leq 10Hz$			2.4		µVp-p
		$10Hz \leq f \leq 1kHz$			2.0	4.0	µV <sub>RMS</sub>
Temperature Hysteresis		(Note 4)			20		ppm
Long-Term Stability	$\Delta V_{OUT}$	$\Delta t = 1000hr$			20		ppm

# Low-Noise, Precision, +2.5V/+4.096V/+5V Voltage Reference

## ELECTRICAL CHARACTERISTICS—(+5.0V)

( $V_{IN} = +10V$ ,  $I_{OUT} = 0mA$ ,  $T_A = T_{MIN}$  to  $T_{MAX}$ , unless otherwise noted. Typical values are at  $T_A = +25^\circ C$ .)

PARAMETER	SYMBOL	CONDITIONS	$T_A$	MIN	TYP	MAX	UNITS
Input Voltage Range	$V_{IN}$			8		40	V
Output Voltage	$V_{OUT}$		+25°C	4.995	5.000	5.005	V
Output Voltage Temperature Coefficient (Note 1)	$TCV_{OUT}$				2	20	ppm/°C
Line Regulation (Note 2)	$\Delta V_{OUT} / \Delta V_{IN}$	$8V \leq V_{IN} \leq 40V$	+25°C		2	7	ppm/V
						45	
Load Regulation (Note 2)	$\Delta V_{OUT} / \Delta I_{OUT}$	Sourcing: $0mA \leq I_{OUT} \leq 15mA$	+25°C		1	6	ppm/mA
						15	
		Sinking: $-15mA \leq I_{OUT} \leq 0mA$	+25°C		1	6	
						30	
Supply Current	$I_{IN}$		+25°C		2.0	3.3	mA
						3.7	
Trim-Adjustment Range	$\Delta V_{OUT}$	(Figure 1)		±30	±50		mV
Turn-On Settling Time	$t_{ON}$	To ±0.01% of final value			5		µs
Output Noise Voltage (Note 3)	$e_N$	$0.1Hz \leq f \leq 10Hz$			3.0		µVp-p
		$10Hz \leq f \leq 1kHz$			2.5	5.0	µVRMS
Temperature Hysteresis		(Note 4)			20		ppm
Long-Term Stability	$\Delta V_{OUT}$	$\Delta t = 1000hr$			20		ppm

**Note 1:** Temperature coefficient is measured by the box method; i.e., the maximum  $\Delta V_{OUT}$  is divided by  $\Delta T \times V_{OUT}$ .

**Note 2:** Line regulation ( $\Delta V_{OUT} / (V_{OUT} \times \Delta V_{IN})$ ) and load regulation ( $\Delta V_{OUT} / (V_{OUT} \times \Delta I_{OUT})$ ) are measured with pulses and do not include output voltage changes due to die-temperature changes.

**Note 3:** Noise specifications are guaranteed by design.

**Note 4:** Temperature hysteresis is specified at  $T_A = +25^\circ C$  by measuring  $V_{OUT}$  before and after changing temperature by  $+25^\circ C$ .

# Low-Noise, Precision, +2.5V/+4.096V/+5V Voltage Reference

**MAX6220**

## Typical Operating Characteristics

( $V_{IN} = +10V$ ,  $I_{OUT} = 0mA$ ,  $T_A = +25^\circ C$ , unless otherwise noted.)

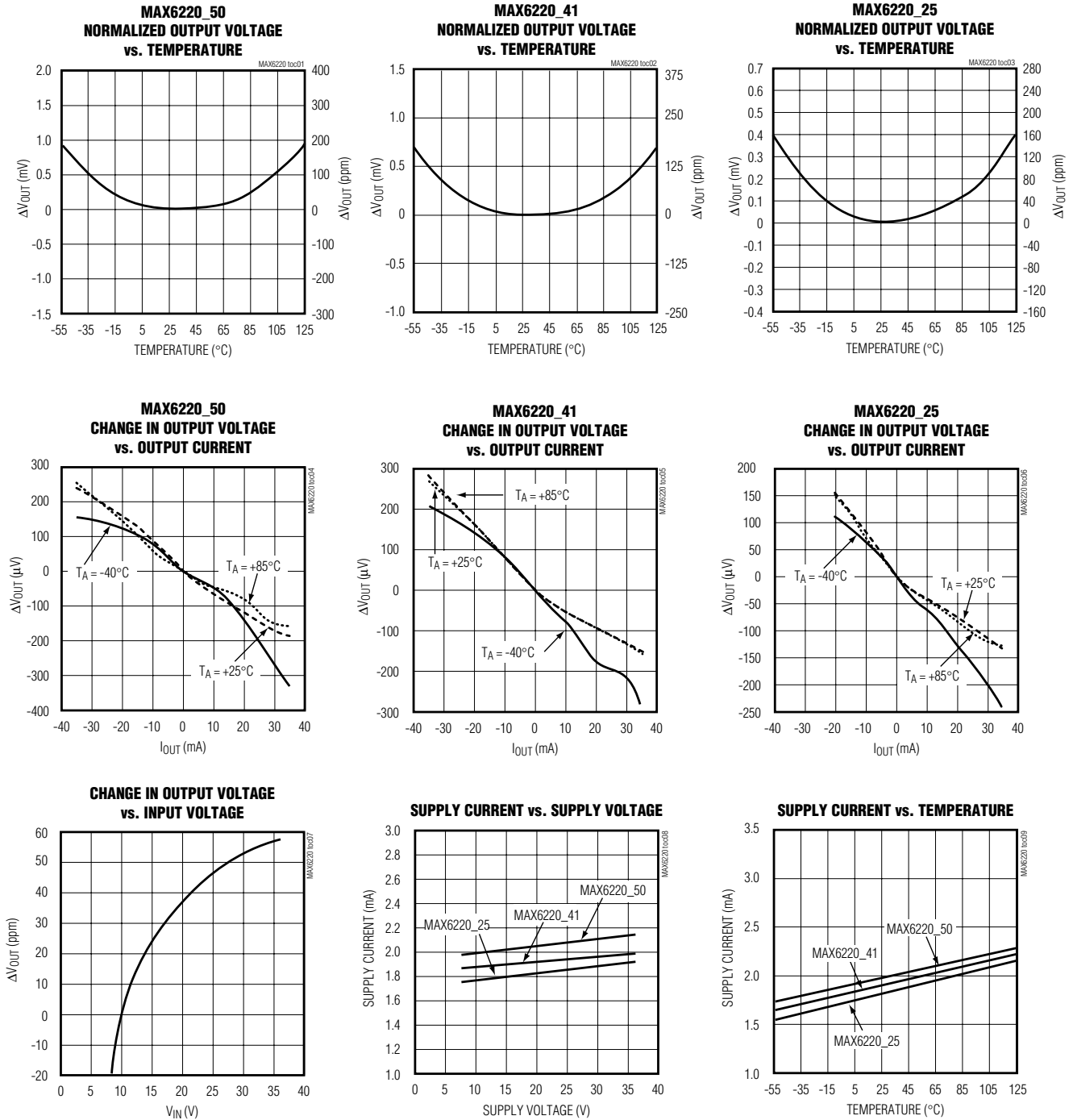

# Low-Noise, Precision, +2.5V/+4.096V/+5V Voltage Reference

## Typical Operating Characteristics (continued)

( $V_{IN} = +10V$ ,  $I_{OUT} = 0mA$ ,  $T_A = +25^\circ C$ , unless otherwise noted.)

**MAX6220\_25**  
OUTPUT NOISE-VOLTAGE DENSITY vs. FREQUENCY

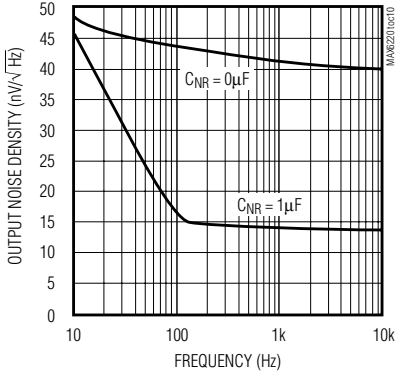

**MAX6220\_41**  
OUTPUT NOISE-VOLTAGE DENSITY vs. FREQUENCY

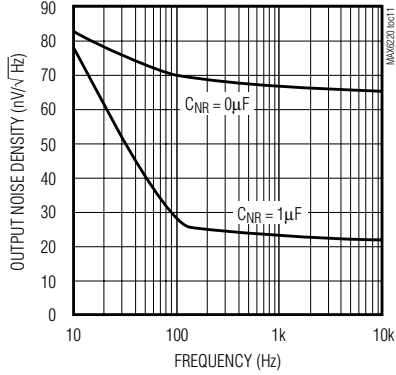

**MAX6220\_50**  
OUTPUT NOISE-VOLTAGE DENSITY vs. FREQUENCY

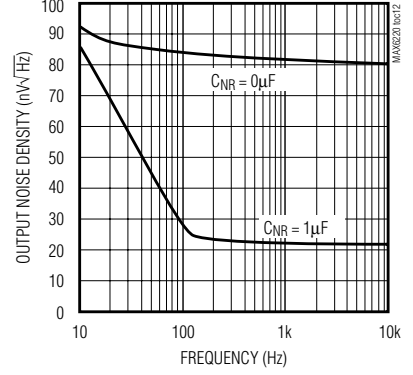

**MAX6220\_25**  
0.1Hz TO 10Hz NOISE

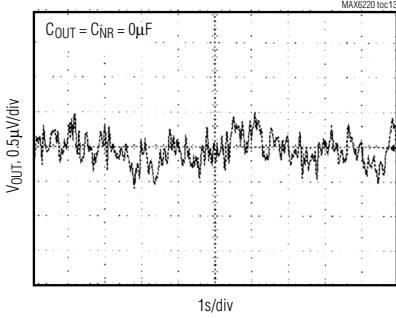

**MAX6220\_41**  
0.1Hz TO 10Hz NOISE

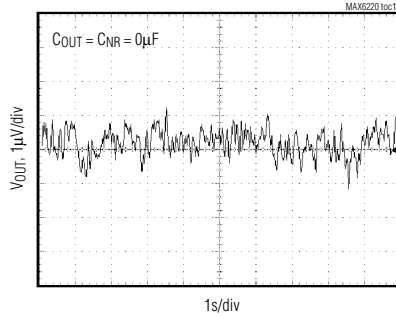

**MAX6220\_50**  
0.1Hz TO 10Hz NOISE

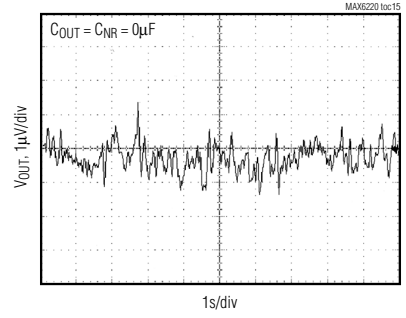

**OUTPUT IMPEDANCE vs. FREQUENCY**

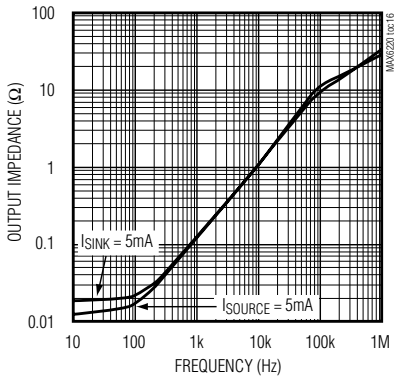

**RIPPLE REJECTION vs. FREQUENCY (C<sub>NR</sub> = 1μF)**

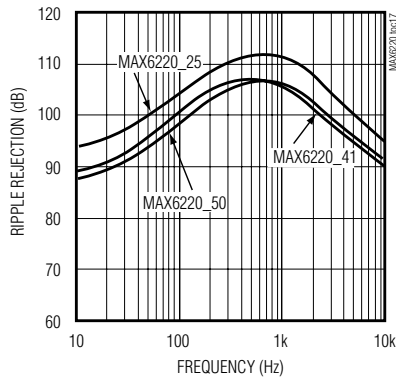

**RIPPLE REJECTION vs. FREQUENCY (C<sub>NR</sub> = 0μF)**

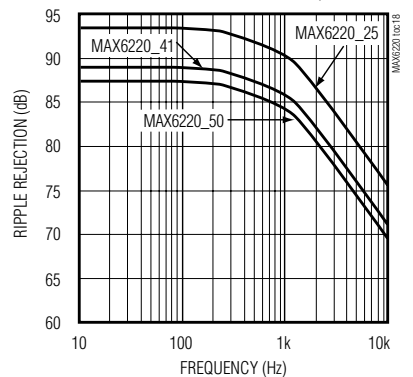

# Low-Noise, Precision, +2.5V/+4.096V/+5V Voltage Reference

## Typical Operating Characteristics (continued)

( $V_{IN} = +10V$ ,  $I_{OUT} = 0mA$ ,  $T_A = +25^\circ C$ , unless otherwise noted.)

MAX6220

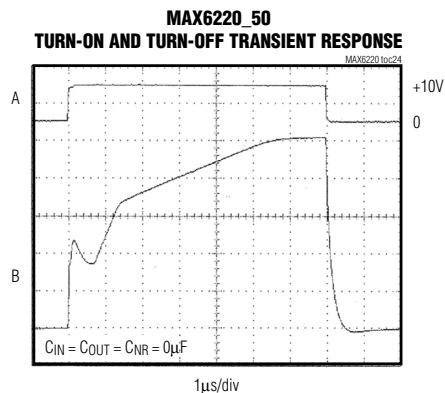
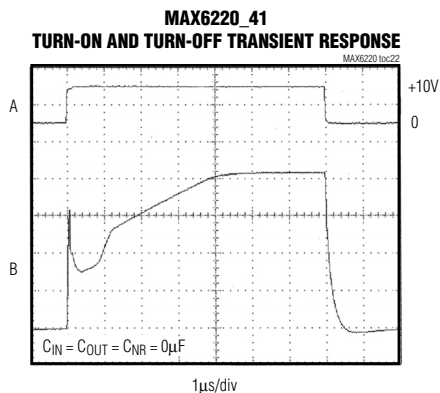
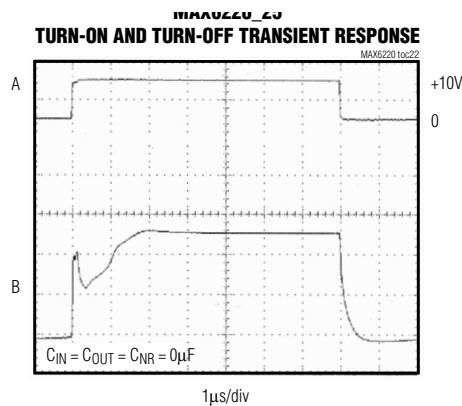
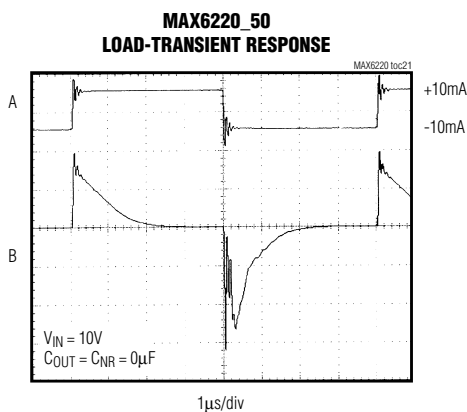
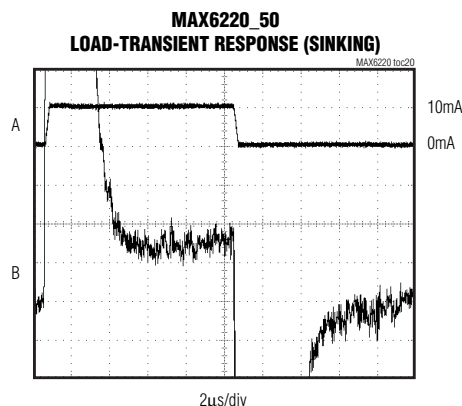
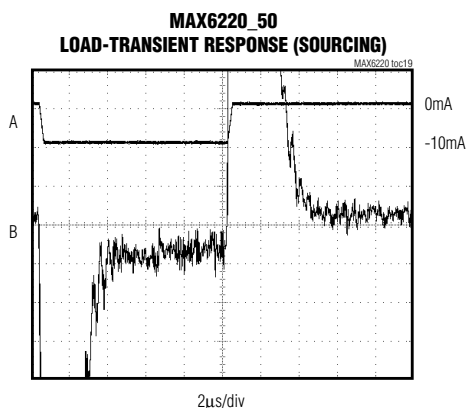

# Low-Noise, Precision, +2.5V/+4.096V/+5V Voltage Reference

## Pin Description

PIN	NAME	FUNCTION
1, 7, 8	I.C.	Internally Connected. <b>Do not use.</b>
2	IN	Positive Power-Supply Input
3	NR	Noise Reduction. Optional capacitor connection for wideband noise reduction. Leave open if not used (Figure 2).
4	GND	Ground
5	TRIM	External Trim Input. Allows $\pm 1\%$ output adjustment (Figure 1). Leave open if not used.
6	OUT	Voltage Reference Output

## Detailed Description

### Temperature Stability

The MAX6220 is a highly stable, low-noise voltage reference that uses a low-power temperature-compensation scheme to achieve laboratory-standard temperature stability. This produces a nearly flat temperature curve, yet does not require the power associated with heated references.

The output voltage can be trimmed 0.6% (min) by connecting a 10k $\Omega$  potentiometer between OUT and GND, and connecting its tap to the TRIM pin (Figure 1). The external trimming does not affect temperature stability.

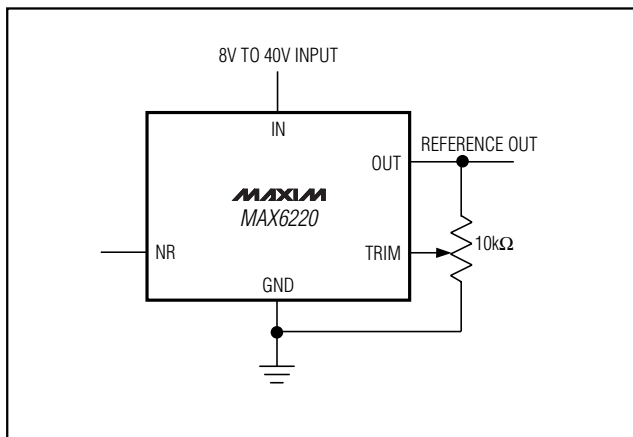

Figure 1. Output Voltage Adjustment

### Noise Reduction

To augment wideband noise reduction, add a 1 $\mu$ F capacitor to the NR pin (Figure 2). Larger values do not improve noise appreciably (see *Typical Operating Characteristics*).

Noise in the power-supply input can affect output noise, but can be reduced by adding an optional bypass capacitor to the IN pin and GND.

### Bypassing

The MAX6220 is stable with capacitive load values from 0 $\mu$ F to 100 $\mu$ F, for all values of load current. Adding an output bypass capacitor can help reduce noise and output glitching caused by load transients.

## Applications Information

### Negative Regulator

Figure 3 shows how both a +5V and -5V precision reference can be obtained from a single unregulated +5V supply. The MAX865 generates approximately  $\pm 9$ V to operate both the MAX6220 reference and the MAX480 inverting amplifier. The +5V is inverted by the MAX480. Resistor R1 is optional, and may be used to trim the  $\pm 5$ V references. R2 and R4 should be matched, both in absolute resistance and temperature coefficient. R3 is optional, and is adjusted to set the -5V reference.

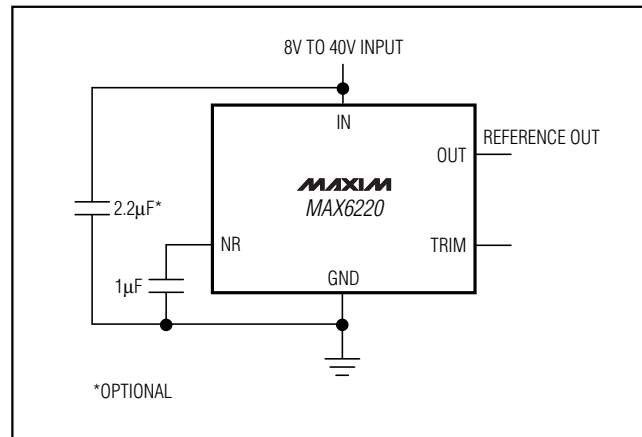

Figure 2. Noise-Reduction Capacitor



# Low-Noise, Precision, +2.5V/+4.096V/+5V Voltage Reference

MAX6220

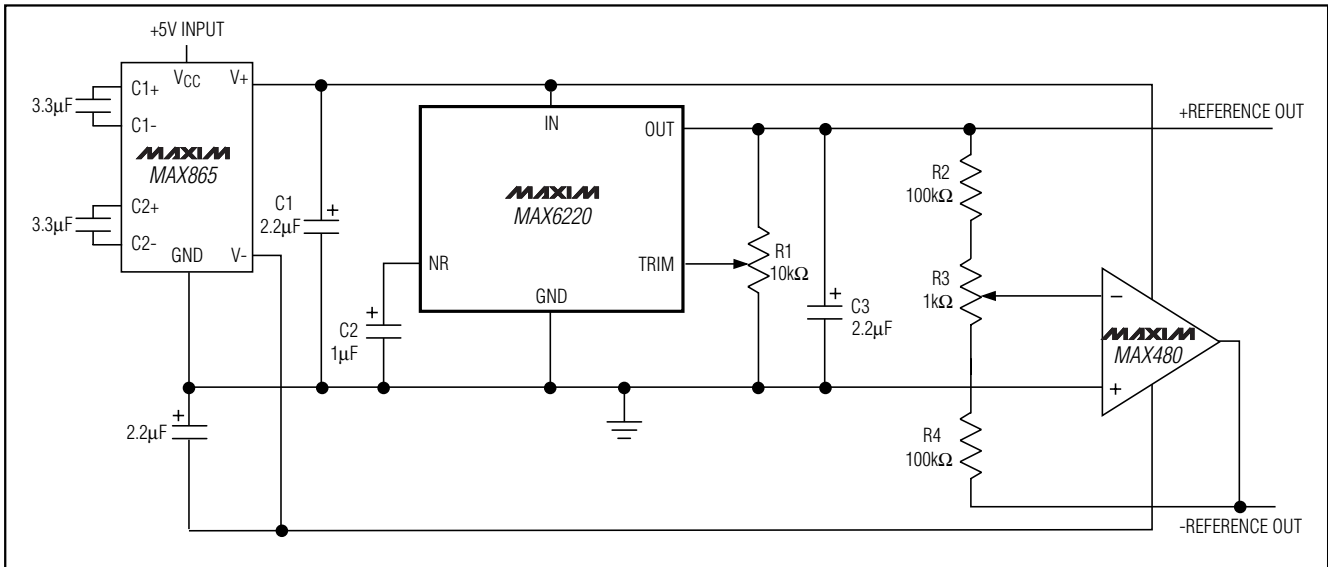

Figure 3. +5V and -5V References from a Single +5V Supply

## Chip Information

TRANSISTOR COUNT: 435

# Low-Noise, Precision, +2.5V/+4.096V/+5V Voltage Reference

## Package Information

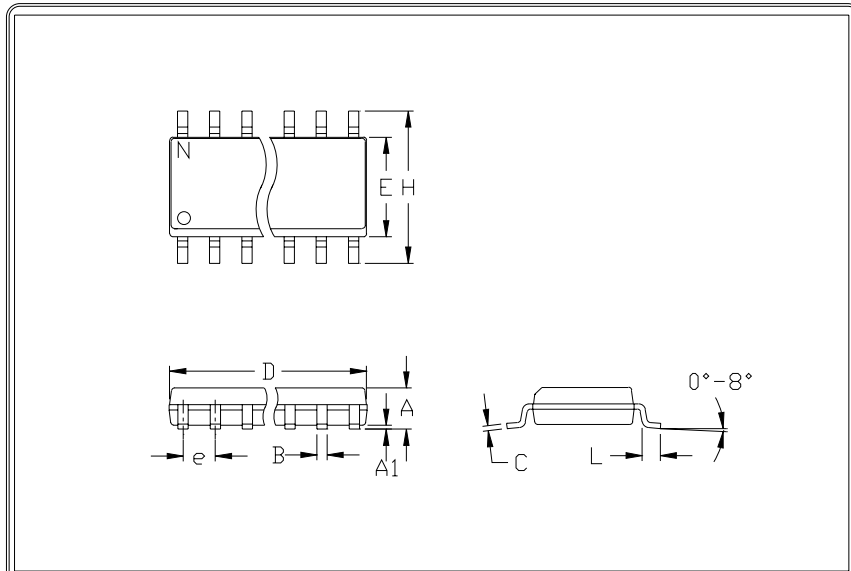

	INCHES		MILLIMETERS	
	MIN	MAX	MIN	MAX
A	0.053	0.069	1.35	1.75
A1	0.004	0.010	0.10	0.25
B	0.014	0.019	0.35	0.49
C	0.007	0.010	0.19	0.25
e	0.050		1.27	
E	0.150	0.157	3.80	4.00
H	0.228	0.244	5.80	6.20
h	0.010	0.020	0.25	0.50
L	0.016	0.050	0.40	1.27

	INCHES		MILLIMETERS		N	MS012
	MIN	MAX	MIN	MAX		
D	0.189	0.197	4.80	5.00	8	A
D	0.337	0.344	8.55	8.75	14	B
D	0.386	0.394	9.80	10.00	16	C

NOTES:

1. D&E DO NOT INCLUDE MOLD FLASH
2. MOLD FLASH OR PROTRUSIONS NOT TO EXCEED .15mm (.006")
3. LEADS TO BE COPLANAR WITHIN .102mm (.004")
4. CONTROLLING DIMENSION: MILLIMETER
5. MEETS JEDEC MS012-XX AS SHOWN IN ABOVE TABLE
6. N = NUMBER OF PINS



PACKAGE FAMILY OUTLINE: SOIC .150"



21-0041 A  
DOCUMENT CONTROL NUMBER REV.

Maxim cannot assume responsibility for use of any circuitry other than circuitry entirely embodied in a Maxim product. No circuit patent licenses are implied. Maxim reserves the right to change the circuitry and specifications without notice at any time.

10 Maxim Integrated Products, 120 San Gabriel Drive, Sunnyvale, CA 94086 (408) 737-7600

# Mouser Electronics

Authorized Distributor

Click to View Pricing, Inventory, Delivery & Lifecycle Information:

## Maxim Integrated:

[MAX6220ASA-2.5+T](#) [MAX6220ASA-4.1+](#) [MAX6220ASA-4.1+T](#) [MAX6220ASA-5.0+T](#) [MAX6220ASA-2.5+](#)  
[MAX6220ASA-5.0+](#)