



Low-Power, Fixed and Adjustable Reference with Shutdown in SOT23

MAX6037

General Description

The MAX6037 family of low-dropout, micropower voltage references offer fixed and adjustable output voltage options ranging from 1.184V to 5V. Connect an external resistive-divider on the MAX6037_ADJ to adjust the output voltage from 1.184V to 5V. The other devices in the MAX6037 family feature fixed output voltages of 1.25V, 2.048V, 2.5V, 3.0V, 3.3V, and 4.096V. The MAX6037 offers shutdown functionality with an active-low shutdown (500nA, max).

These series-mode voltage references operate from a 2.5V to 5.5V supply and consume 275 μ A (max) quiescent current. The output is stable driving loads from 0.02 μ F to 1 μ F and can source and sink 5mA of load current. The MAX6037 offers a low temperature coefficient of 25ppm/ $^{\circ}$ C and initial accuracy of \pm 0.2% (max). The low dropout voltage (100mV, max at 1mA) and supply-independent, low supply current make the MAX6037 ideal for battery-powered applications.

The MAX6037 is available in the miniature 5-pin SOT23 package and is specified over the -40 $^{\circ}$ C to +125 $^{\circ}$ C automotive temperature range.

Applications

Medical Equipment	Portable Equipment
Wireless LAN	Precision Regulators

Features

- ◆ Adjustable V_{OUT}: 1.184V to 5V
- ◆ Fixed Outputs: 1.25V, 2.048V, 2.5V, 3.0V, 3.3V, and 4.096V
- ◆ Shutdown Current < 500nA (max)
- ◆ 25ppm/ $^{\circ}$ C (max) Temperature Coefficient (A Grade)
- ◆ \pm 0.2% (max) Initial Accuracy (A Grade)
- ◆ Low 100mV (max) Dropout Voltage at 1mA Load Current
- ◆ 2.5V to 5.5V Input Voltage Range
- ◆ 5mA Sink and Source Current Capability
- ◆ Available in 5-Pin SOT23 Package
- ◆ Operates Over the Automotive Temperature Range: -40 $^{\circ}$ C to +125 $^{\circ}$ C

Typical Operating Circuit

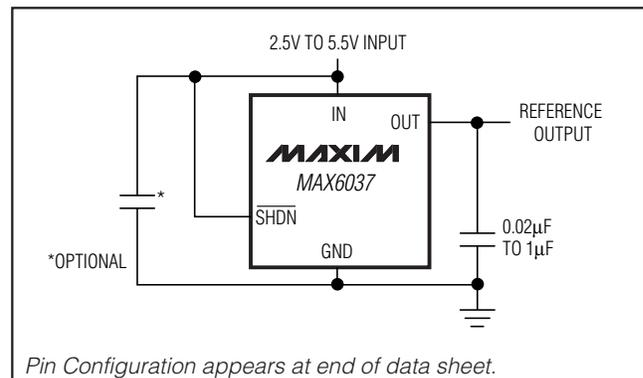

Ordering Information/Selector Guide

PART	OUTPUT VOLTAGE (V)	INITIAL ACCURACY %	MAX TEMPCO (ppm/ $^{\circ}$ C)	PIN-PACKAGE	PKG CODE	TOP MARK
MAX6037AAUK12+T	1.25	0.2	25	5 SOT23-5	U5-2	AEIV
MAX6037BAUK12+T	1.25	0.3	50	5 SOT23-5	U5-2	AEIW
MAX6037CAUK12+T	1.25	0.5	50	5 SOT23-5	U5-2	AEIX
MAX6037AAUK21+T	2.048	0.2	25	5 SOT23-5	U5-2	AEIY
MAX6037BAUK21+T	2.048	0.3	50	5 SOT23-5	U5-2	AEIZ
MAX6037CAUK21+T	2.048	0.5	50	5 SOT23-5	U5-2	AEJA

+ Denotes a lead-free package.

T = Tape and reel.

Note: All devices are specified over the -40 $^{\circ}$ C to +125 $^{\circ}$ C operating temperature range.

Ordering Information/Selector Guide continued at end of data sheet.



Maxim Integrated Products 1

For pricing delivery, and ordering information please contact Maxim Direct at 1-888-629-4642, or visit Maxim's website at www.maxim-ic.com.

Low-Power, Fixed and Adjustable Reference with Shutdown in SOT23

ABSOLUTE MAXIMUM RATINGS

IN, OUT, $\overline{\text{SHDN}}$, ADJ to GND -0.3V to +6V
 Output Short Circuit to GND or IN Continuous
 Continuous Power Dissipation ($T_A = +70^\circ\text{C}$)
 5-Pin SOT23 (derate 7.1mW/ $^\circ\text{C}$ above +70 $^\circ\text{C}$) 571mW

Operating Temperature Range -40 $^\circ\text{C}$ to +125 $^\circ\text{C}$
 Junction Temperature +150 $^\circ\text{C}$
 Storage Temperature Range -65 $^\circ\text{C}$ to +150 $^\circ\text{C}$
 Lead Temperature (soldering, 10s) +300 $^\circ\text{C}$

Stresses beyond those listed under "Absolute Maximum Ratings" may cause permanent damage to the device. These are stress ratings only, and functional operation of the device at these or any other conditions beyond those indicated in the operational sections of the specifications is not implied. Exposure to absolute maximum rating conditions for extended periods may affect device reliability.

ELECTRICAL CHARACTERISTICS—MAX6037_12 ($V_{\text{OUT}} = 1.25\text{V}$)

($V_{\text{IN}} = V_{\overline{\text{SHDN}}} = +3\text{V}$, $I_{\text{OUT}} = 0$, $C_{\text{OUT}} = 0.1\mu\text{F}$, $T_A = T_{\text{MIN}}$ to T_{MAX} , unless otherwise noted. Typical values are at $T_A = +25^\circ\text{C}$.) (Note 1)

PARAMETER	SYMBOL	CONDITIONS	MIN	TYP	MAX	UNITS	
OUTPUT							
Output Voltage	V_{OUT}	$T_A = +25^\circ\text{C}$	MAX6037A_12 (0.2%)	1.2475	1.250	1.2525	V
			MAX6037B_12 (0.3%)	1.2462	1.250	1.2538	
			MAX6037C_12 (0.5%)	1.2438	1.250	1.2563	
Output-Voltage Temperature Coefficient (Note 2, 4)	TCV_{OUT}	MAX6037A_12		6	25	ppm/ $^\circ\text{C}$	
		MAX6037B/C_12		6	50		
Line Regulation	$\Delta V_{\text{OUT}}/\Delta V_{\text{IN}}$	$2.5\text{V} \leq V_{\text{IN}} \leq 5.5\text{V}$		0.0006	0.0096	%/V	
Load Regulation	$\Delta V_{\text{OUT}}/\Delta I_{\text{OUT}}$	Sourcing: $0 \leq I_{\text{OUT}} \leq 1\text{mA}$		0.008	0.072	%mA	
		Sourcing: $1\text{mA} \leq I_{\text{OUT}} \leq 5\text{mA}$		0.006	0.072		
		Sinking: $-1\text{mA} \leq I_{\text{OUT}} \leq 0$		0.025	0.12		
		Sinking: $-5\text{mA} \leq I_{\text{OUT}} \leq -1\text{mA}$		0.014	0.12		
OUT Short-Circuit Current	I_{SC}	Short to GND		16		mA	
		Short to IN		32			
Thermal Hysteresis (Note 3)	$\Delta V_{\text{OUT}}/\text{cycle}$			485		ppm	
Long-Term Stability	$\Delta V_{\text{OUT}}/\text{time}$	1000h at $T_A = +25^\circ\text{C}$		133		ppm	
DYNAMIC							
Noise Voltage	e_{OUT}	$f = 0.1\text{Hz}$ to 10Hz		6		$\mu\text{V}_{\text{P-P}}$	
		$f = 10\text{Hz}$ to 1kHz		15		μV_{RMS}	
Turn-On Settling Time	t_{R}	$T_{\text{O}} V_{\text{OUT}} = 0.1\%$ of final value, $C_{\text{OUT}} = 0.02\mu\text{F}$	Initial power-up	360		μs	
			$V_{\text{IN}} = 3\text{V}$, $\overline{\text{SHDN}}$ pulled from low to high	75			
Output Impedance when Disabled	Z_{OUT}	$V_{\text{IN}} = 3\text{V}$, $V_{\overline{\text{SHDN}}} = 0\text{V}$		125		$\text{k}\Omega$	
Capacitive-Load Stability Range (Note 4)	C_{OUT}		0.02		1	μF	
INPUT							
Supply Voltage Range	V_{IN}	Guaranteed by line regulation test	2.5		5.5	V	
Quiescent Supply Current	I_{IN}			190	275	μA	
Shutdown Supply Current	$I_{\overline{\text{SHDN}}}$	$V_{\overline{\text{SHDN}}} = 0\text{V}$		0.05	500	nA	

Low-Power, Fixed and Adjustable Reference with Shutdown in SOT23

MAX6037

ELECTRICAL CHARACTERISTICS—MAX6037_12 (V_{OUT} = 1.25V) (continued)

(V_{IN} = V_{SHDN} = +3V, I_{OUT} = 0, C_{OUT} = 0.1μF, T_A = T_{MIN} to T_{MAX}, unless otherwise noted. Typical values are at T_A = +25°C.) (Note 1)

PARAMETER	SYMBOL	CONDITIONS	MIN	TYP	MAX	UNITS
SHUTDOWN ($\overline{\text{SHDN}}$)						
Logic-High Input Voltage	V _{ENH}	2.5V ≤ V _{IN} ≤ 5.5V	2.0			V
Logic-Low Input Voltage	V _{ENL}	2.5V ≤ V _{IN} ≤ 5.5V			0.7	V
Logic-High Input Current	I _{ENH}	2.5V ≤ V _{IN} ≤ 5.5V, V _{SHDN} = V _{IN}	-1000	0.15	+1000	nA
Logic-Low Input Current	I _{ENL}	2.5V ≤ V _{IN} ≤ 5.5V, V _{SHDN} = 0V	-1000	0.05	+1000	nA

ELECTRICAL CHARACTERISTICS—MAX6037_21 (V_{OUT} = 2.048V)

(V_{IN} = V_{SHDN} = +3V, I_{OUT} = 0, C_{OUT} = 0.1μF, T_A = T_{MIN} to T_{MAX}, unless otherwise noted. Typical values are at T_A = +25°C.) (Note 1)

PARAMETER	SYMBOL	CONDITIONS	MIN	TYP	MAX	UNITS	
OUTPUT							
Output Voltage	V _{OUT}	T _A = +25°C	MAX6037A_21 (0.2%)	2.0439	2.0480	2.0521	V
			MAX6037B_21 (0.3%)	2.0418	2.0480	2.0542	
			MAX6037C_21 (0.5%)	2.0378	2.0480	2.0582	
Output-Voltage Temperature Coefficient (Note 2, 4)	TCV _{OUT}	MAX6037A_21		6	25	ppm/°C	
		MAX6037B/C_21		6	50		
Line Regulation	ΔV _{OUT} /ΔV _{IN}	2.5V ≤ V _{IN} ≤ 5.5V		0.0008	0.0107	%/V	
Load Regulation	ΔV _{OUT} /ΔI _{OUT}	Sourcing: 0 ≤ I _{OUT} ≤ 1mA		0.006	0.044	%mA	
		Sourcing: 1mA ≤ I _{OUT} ≤ 5mA		0.004	0.044		
		Sinking: -1mA ≤ I _{OUT} ≤ 0		0.02	0.195		
		Sinking: -5mA ≤ I _{OUT} ≤ -1mA		0.01	0.195		
OUT Short-Circuit Current	I _{SC}	Short to GND		16		mA	
		Short to IN		32			
Thermal Hysteresis (Note 3)	ΔV _{OUT} /cycle			458		ppm	
Long-Term Stability	ΔV _{OUT} /time	1000h at T _A = +25°C		133		ppm	
DYNAMIC							
Noise Voltage	e _{OUT}	f = 0.1Hz to 10Hz		11		μV _{P-P}	
		f = 10Hz to 1kHz		25		μV _{RMS}	
Turn-On Settling Time	t _R	To V _{OUT} = 0.1% of final value, C _{OUT} = 0.02μF	Initial power-up	2.1		ms	
			V _{IN} = 3V, $\overline{\text{SHDN}}$ pulled from low to high	2			
Output Impedance when Disabled	Z _{OUT}	V _{IN} = 3V, V _{SHDN} = 0V		205		kΩ	
Capacitive-Load Stability Range (Note 4)	C _{OUT}		0.02		1	μF	
INPUT							
Supply Voltage Range	V _{IN}	Guaranteed by line regulation test	2.5		5.5	V	
Quiescent Supply Current	I _{IN}			190	275	μA	
Shutdown Supply Current	I _{SHDN}	V _{SHDN} = 0V		0.05	500	nA	

Low-Power, Fixed and Adjustable Reference with Shutdown in SOT23

ELECTRICAL CHARACTERISTICS—MAX6037_21 (V_{OUT} = 2.048V) (continued)

(V_{IN} = V_{SHDN} = +3V, I_{OUT} = 0, C_{OUT} = 0.1μF, T_A = T_{MIN} to T_{MAX}, unless otherwise noted. Typical values are at T_A = +25°C.) (Note 1)

PARAMETER	SYMBOL	CONDITIONS	MIN	TYP	MAX	UNITS
SHUTDOWN (SHDN)						
Logic-High Input Voltage	V _{ENH}	2.5V ≤ V _{IN} ≤ 5.5V	2.0			V
Logic-Low Input Voltage	V _{ENL}	2.5V ≤ V _{IN} ≤ 5.5V			0.7	V
Logic-High Input Current	I _{ENH}	2.5V ≤ V _{IN} ≤ 5.5V, V _{SHDN} = V _{IN}	-1000	0.15	+1000	nA
Logic-Low Input Current	I _{ENL}	2.5V ≤ V _{IN} ≤ 5.5V, V _{SHDN} = 0V	-1000	0.05	+1000	nA

ELECTRICAL CHARACTERISTICS—MAX6037_25 (V_{OUT} = 2.500V)

(V_{IN} = V_{SHDN} = +5V, I_{OUT} = 0, C_{OUT} = 0.1μF, T_A = T_{MIN} to T_{MAX}, unless otherwise noted. Typical values are at T_A = +25°C.) (Note 1)

PARAMETER	SYMBOL	CONDITIONS	MIN	TYP	MAX	UNITS	
OUTPUT							
Output Voltage	V _{OUT}	T _A = +25°C	MAX6037A_25 (0.2%)	2.4950	2.500	2.5050	V
			MAX6037B_25 (0.3%)	2.4925	2.500	2.5075	
			MAX6037C_25 (0.5%)	2.4875	2.500	2.5125	
Output-Voltage Temperature Coefficient (Note 2, 4)	TCV _{OUT}	MAX6037A_25		6	25	ppm/°C	
		MAX6037B/C_25		6	50		
Line Regulation	ΔV _{OUT} /ΔV _{IN}	(V _{OUT} + 0.2V) ≤ V _{IN} ≤ 5.5V		0.0004	0.012	%/V	
Load Regulation	ΔV _{OUT} /ΔI _{OUT}	Sourcing: 0 ≤ I _{OUT} ≤ 1mA		0.005	0.036	%mA	
		Sourcing: 1mA ≤ I _{OUT} ≤ 5mA		0.003	0.036		
		Sinking: -1mA ≤ I _{OUT} ≤ 0		0.02	0.2		
		Sinking: -5mA ≤ I _{OUT} ≤ -1mA		0.01	0.2		
OUT Short-Circuit Current	I _{SC}	Short to GND		33		mA	
		Short to IN		32			
Dropout Voltage (Note 5)	V _{IN} - V _{OUT}	I _{SOURCE} = 1mA		40	100	mV	
		I _{SOURCE} = 5mA		190	410		
Thermal Hysteresis (Note 3)	ΔV _{OUT} /cycle			514		ppm	
Long-Term Stability	ΔV _{OUT} /time	1000h at T _A = +25°C		133		ppm	
DYNAMIC							
Noise Voltage	e _{OUT}	f = 0.1Hz to 10Hz		14		μV _{P-P}	
		f = 10Hz to 1kHz		30		μV _{RMS}	
Turn-On Settling Time	t _R	To V _{OUT} = 0.1% of final value, C _{OUT} = 0.02μF	Initial power-up	2.2		ms	
			V _{IN} = 5V, SHDN pulled from low to high	2			
Output Impedance when Disabled	Z _{OUT}	V _{IN} = 5V, V _{SHDN} = 0V		250		kΩ	
Capacitive-Load Stability Range (Note 4)	C _{OUT}		0.02		1	μF	

Low-Power, Fixed and Adjustable Reference with Shutdown in SOT23

MAX6037

ELECTRICAL CHARACTERISTICS—MAX6037_25 (V_{OUT} = 2.500V) (continued)

(V_{IN} = V_{SHDN} = +5V, I_{OUT} = 0, C_{OUT} = 0.1μF, T_A = T_{MIN} to T_{MAX}, unless otherwise noted. Typical values are at T_A = +25°C.) (Note 1)

PARAMETER	SYMBOL	CONDITIONS	MIN	TYP	MAX	UNITS
INPUT						
Supply Voltage Range	V _{IN}	Guaranteed by line regulation test	2.7		5.5	V
Quiescent Supply Current	I _{IN}			210	275	μA
Shutdown Supply Current	I _{SHDN}	V _{SHDN} = 0V		0.05	500	nA
SHUTDOWN (SHDN)						
Logic-High Input Voltage	V _{ENH}	2.7V ≤ V _{IN} ≤ 5.5V	2.0			V
Logic-Low Input Voltage	V _{ENL}	2.7V ≤ V _{IN} ≤ 5.5V			0.75	V
Logic-High Input Current	I _{ENH}	2.7V ≤ V _{IN} ≤ 5.5V, V _{SHDN} = V _{IN}	-1000	0.15	+1000	nA
Logic-Low Input Current	I _{ENL}	2.7V ≤ V _{IN} ≤ 5.5V, V _{SHDN} = 0V	-1000	0.05	+1000	nA

ELECTRICAL CHARACTERISTICS—MAX6037_30 (V_{OUT} = 3.000V)

(V_{IN} = V_{SHDN} = +5V, I_{OUT} = 0, C_{OUT} = 0.1μF, T_A = T_{MIN} to T_{MAX}, unless otherwise noted. Typical values are at T_A = +25°C.) (Note 1)

PARAMETER	SYMBOL	CONDITIONS	MIN	TYP	MAX	UNITS	
OUTPUT							
Output Voltage	V _{OUT}	T _A = +25°C	MAX6037A_30 (0.2%)	2.9940	3.000	3.0060	V
			MAX6037B_30 (0.3%)	2.9910	3.000	3.0090	
			MAX6037C_30 (0.5%)	2.9850	3.000	3.0150	
Output-Voltage Temperature Coefficient (Note 2, 4)	TC _{VOUT}	MAX6037A_30		6	25	ppm/°C	
		MAX6037B/C_30		6	50		
Line Regulation	ΔV _{OUT} /ΔV _{IN}	(V _{OUT} + 0.2V) ≤ V _{IN} ≤ 5.5V		0.0004	0.0133	%/V	
Load Regulation	ΔV _{OUT} /ΔI _{OUT}	Sourcing: 0 ≤ I _{OUT} ≤ 1mA		0.005	0.035	%mA	
		Sourcing: 1mA ≤ I _{OUT} ≤ 5mA		0.008	0.03		
		Sinking: -1mA ≤ I _{OUT} ≤ 0		0.02	0.2		
		Sinking: -5mA ≤ I _{OUT} ≤ -1mA		0.01	0.2		
OUT Short-Circuit Current	I _{SC}	Short to GND		33		mA	
		Short to IN		32			
Dropout Voltage (Note 5)	V _{IN} - V _{OUT}	I _{SOURCE} = 1mA		40	100	mV	
		I _{SOURCE} = 5mA		190	410		
Thermal Hysteresis (Note 3)	ΔV _{OUT} /cycle			501		ppm	
Long-Term Stability	ΔV _{OUT} /time	1000h at T _A = +25°C		133		ppm	
DYNAMIC							
Noise Voltage	e _{OUT}	f = 0.1Hz to 10Hz		17		μV _{P-P}	
		f = 10Hz to 1kHz		40		μV _{RMS}	
Turn-On Settling Time	t _R	To V _{OUT} = 0.1% of final value, C _{OUT} = 0.02μF	Initial power-up	2.4		ms	
			V _{IN} = 5V, SHDN pulled from low to high	2.1			

Low-Power, Fixed and Adjustable Reference with Shutdown in SOT23

ELECTRICAL CHARACTERISTICS—MAX6037_30 (V_{OUT} = 3.000V) (continued)

(V_{IN} = V_{SHDN} = +5V, I_{OUT} = 0, C_{OUT} = 0.1μF, T_A = T_{MIN} to T_{MAX}, unless otherwise noted. Typical values are at T_A = +25°C.) (Note 1)

PARAMETER	SYMBOL	CONDITIONS	MIN	TYP	MAX	UNITS
Output Impedance when Disabled	Z _{OUT}	V _{IN} = 5V, V _{SHDN} = 0V		300		kΩ
Capacitive-Load Stability Range (Note 4)	C _{OUT}		0.02		1	μF
INPUT						
Supply Voltage Range	V _{IN}	Guaranteed by line regulation test	3.2		5.5	V
Quiescent Supply Current	I _{IN}			210	275	μA
Shutdown Supply Current	I _{SHDN}	V _{SHDN} = 0V		0.05	500	nA
SHUTDOWN (SHDN)						
Logic-High Input Voltage	V _{ENH}	3.2V ≤ V _{IN} ≤ 5.5V	2.0			V
Logic-Low Input Voltage	V _{ENL}	3.2V ≤ V _{IN} ≤ 5.5V			0.8	V
Logic-High Input Current	I _{ENH}	3.2V ≤ V _{IN} ≤ 5.5V, V _{SHDN} = V _{IN}	-1000	0.15	+1000	nA
Logic-Low Input Current	I _{ENL}	3.2V ≤ V _{IN} ≤ 5.5V, V _{SHDN} = 0V	-1000	0.05	+1000	nA

ELECTRICAL CHARACTERISTICS—MAX6037_33 (V_{OUT} = 3.300V)

(V_{IN} = V_{SHDN} = +5V, I_{OUT} = 0, C_{OUT} = 0.1μF, T_A = T_{MIN} to T_{MAX}, unless otherwise noted. Typical values are at T_A = +25°C.) (Note 1)

PARAMETER	SYMBOL	CONDITIONS	MIN	TYP	MAX	UNITS	
OUTPUT							
Output Voltage	V _{OUT}	T _A = +25°C	MAX6037A_33 (0.2%)	3.2934	3.300	3.3066	V
			MAX6037B_33 (0.3%)	3.2901	3.300	3.3099	
			MAX6037C_33 (0.5%)	3.2855	3.300	3.3165	
Output-Voltage Temperature Coefficient (Note 2, 4)	TCV _{OUT}	MAX6037A_33		6	25	ppm/°C	
		MAX6037B/C_33		6	50		
Line Regulation	ΔV _{OUT} /ΔV _{IN}	(V _{OUT} + 0.2V) ≤ V _{IN} ≤ 5.5V		0.0003	0.0133	%/V	
Load Regulation	ΔV _{OUT} /ΔI _{OUT}	Sourcing: 0 ≤ I _{OUT} ≤ 1mA		0.005	0.027	%mA	
		Sourcing: 1mA ≤ I _{OUT} ≤ 5mA		0.002	0.027		
		Sinking: -1mA ≤ I _{OUT} ≤ 0		0.02	0.212		
		Sinking: -5mA ≤ I _{OUT} ≤ -1mA		0.01	0.212		
OUT Short-Circuit Current	I _{SC}	Short to GND		33		mA	
		Short to IN		32			
Dropout Voltage (Note 5)	V _{IN} - V _{OUT}	I _{SOURCE} = 1mA		40	100	mV	
		I _{SOURCE} = 5mA		190	410		
Thermal Hysteresis (Note 3)	ΔV _{OUT} /cycle			514		ppm	
Long-Term Stability	ΔV _{OUT} /time	1000h at T _A = +25°C		133		ppm	

Low-Power, Fixed and Adjustable Reference with Shutdown in SOT23

MAX6037

ELECTRICAL CHARACTERISTICS—MAX6037_33 (V_{OUT} = 3.300V) (continued)

(V_{IN} = V_{SHDN} = +5V, I_{OUT} = 0, C_{OUT} = 0.1μF, T_A = T_{MIN} to T_{MAX}, unless otherwise noted. Typical values are at T_A = +25°C.) (Note 1)

PARAMETER	SYMBOL	CONDITIONS	MIN	TYP	MAX	UNITS
DYNAMIC						
Noise Voltage	e _{OUT}	f = 0.1Hz to 10Hz		19		μV _{P-P}
		f = 10Hz to 1kHz		45		μV _{RMS}
Turn-On Settling Time	t _R	To V _{OUT} = 0.1% of final value, C _{OUT} = 0.02μF	Initial power-up		2.6	ms
			V _{IN} = 5V, $\overline{\text{SHDN}}$ pulled from low to high		2.4	
Output Impedance when Disabled	Z _{OUT}	V _{IN} = 5V, V _{SHDN} = 0V		330		kΩ
Capacitive-Load Stability Range (Note 4)	C _{OUT}		0.02		1	μF
INPUT						
Supply Voltage Range	V _{IN}	Guaranteed by line regulation test	3.5		5.5	V
Quiescent Supply Current	I _{IN}			210	275	μA
Shutdown Supply Current	I _{SHDN}	V _{SHDN} = 0V		0.05	500	nA
SHUTDOWN ($\overline{\text{SHDN}}$)						
Logic-High Input Voltage	V _{ENH}	3.5V ≤ V _{IN} ≤ 5.5V	2.0			V
Logic-Low Input Voltage	V _{ENL}	3.5V ≤ V _{IN} ≤ 5.5V			0.8	V
Logic-High Input Current	I _{ENH}	3.5V ≤ V _{IN} ≤ 5.5V, V _{SHDN} = V _{IN}	-1000	0.15	+1000	nA
Logic-Low Input Current	I _{ENL}	3.5V ≤ V _{IN} ≤ 5.5V, V _{SHDN} = 0V	-1000	0.05	+1000	nA

ELECTRICAL CHARACTERISTICS—MAX6037_41 (V_{OUT} = 4.096V)

(V_{IN} = V_{SHDN} = +5V, I_{OUT} = 0, C_{OUT} = 0.1μF, T_A = T_{MIN} to T_{MAX}, unless otherwise noted. Typical values are at T_A = +25°C.) (Note 1)

PARAMETER	SYMBOL	CONDITIONS	MIN	TYP	MAX	UNITS	
OUTPUT							
Output Voltage	V _{OUT}	T _A = +25°C	MAX6037A_41 (0.2%)	4.0878	4.096	4.1042	V
			MAX6037B_41 (0.3%)	4.0837	4.096	4.1083	
			MAX6037C_41 (0.5%)	4.0755	4.096	4.1165	
Output-Voltage Temperature Coefficient (Note 2, 4)	TCV _{OUT}	MAX6037A_41		6	25	ppm/°C	
		MAX6037B/C_41		6	50		
Line Regulation	ΔV _{OUT} /ΔV _{IN}	(V _{OUT} + 0.2V) ≤ V _{IN} ≤ 5.5V		0.0003	0.0105	%/V	
Load Regulation	ΔV _{OUT} /ΔI _{OUT}	Sourcing: 0 ≤ I _{OUT} ≤ 1mA		0.004	0.35	%mA	
		Sourcing: 1mA ≤ I _{OUT} ≤ 5mA		0.002	0.027		
		Sinking: -1mA ≤ I _{OUT} ≤ 0		0.02	0.212		
		Sinking: -5mA ≤ I _{OUT} ≤ -1mA		0.01	0.212		

Low-Power, Fixed and Adjustable Reference with Shutdown in SOT23

ELECTRICAL CHARACTERISTICS—MAX6037_41 (V_{OUT} = 4.096V) (continued)

(V_{IN} = V_{SHDN} = +5V, I_{OUT} = 0, C_{OUT} = 0.1μF, T_A = T_{MIN} to T_{MAX}, unless otherwise noted. Typical values are at T_A = +25°C.) (Note 1)

PARAMETER	SYMBOL	CONDITIONS	MIN	TYP	MAX	UNITS
OUT Short-Circuit Current	I _{SC}	Short to GND		33		mA
		Short to I _N		32		
Dropout Voltage (Note 5)	V _{IN} - V _{OUT}	I _{SOURCE} = 1mA		40	100	mV
		I _{SOURCE} = 5mA		190	410	
Thermal Hysteresis (Note 3)	ΔV _{OUT} /cycle			524		ppm
Long-Term Stability	ΔV _{OUT} /time	1000h at T _A = +25°C		133		ppm
DYNAMIC						
Noise Voltage	e _{OUT}	f = 0.1Hz to 10Hz		24		μV _{P-P}
		f = 10Hz to 1kHz		50		μV _{RMS}
Turn-On Settling Time	t _R	To V _{OUT} = 0.1% of final value, C _{OUT} = 0.02μF	Initial power-up	3.2		ms
			V _{IN} = 5V, $\overline{\text{SHDN}}$ pulled from low to high	3.2		
Output Impedance when Disabled	Z _{OUT}	V _{IN} = 5V, V _{SHDN} = 0		410		kΩ
Capacitive-Load Stability Range (Note 4)	C _{OUT}		0.02		1	μF
INPUT						
Supply Voltage Range	V _{IN}	Guaranteed by line regulation test	4.3		5.5	V
Quiescent Supply Current	I _{IN}			210	275	μA
Shutdown Supply Current	I _{SHDN}	V _{SHDN} = 0V		0.05	500	nA
SHUTDOWN (SHDN)						
Logic-High Input Voltage	V _{ENH}	4.3V ≤ V _{IN} ≤ 5.5V	2.0			V
Logic-Low Input Voltage	V _{ENL}	4.3V ≤ V _{IN} ≤ 5.5V			0.8	V
Logic-High Input Current	I _{ENH}	4.3V ≤ V _{IN} ≤ 5.5V, V _{SHDN} = V _{IN}	-1000	0.15	+1000	nA
Logic-Low Input Current	I _{ENL}	4.3V ≤ V _{IN} ≤ 5.5V, V _{SHDN} = 0V	-1000	0.05	+1000	nA

Low-Power, Fixed and Adjustable Reference with Shutdown in SOT23

MAX6037

ELECTRICAL CHARACTERISTICS—MAX6037_ADJ (V_{OUT} = 1.184V to 5V)

(V_{IN} = V_{SHDN} = +5V, I_{OUT} = 0, T_A = T_{MIN} to T_{MAX}, ADJ shorted to OUT unless otherwise noted. Typical values are at T_A = +25°C.) (Note 1)

PARAMETER	SYMBOL	CONDITIONS	MIN	TYP	MAX	UNITS	
OUTPUT							
Initial Output Voltage (Note 6)	V _{OUT}	T _A = +25°C	MAX6037A_ADJ (0.2%)	1.1816	1.1840	1.1864	V
			MAX6037B_ADJ (0.3%)	1.1805	1.1840	1.1875	
			MAX6037C_ADJ (0.5%)	1.1781	1.1840	1.1899	
Output Voltage Range	V _{OUT}		1.184	V _{IN} - 0.15		V	
Output-Voltage Temperature Coefficient (Notes 2, 4, 7)	TCV _{OUT}	MAX6037A_ADJ		6	25	ppm/°C	
		MAX6037B/C_ADJ		6	50		
Line Regulation (Note 8)	ΔV _{OUT} /ΔV _{IN}	2.5V ≤ V _{IN} ≤ 5.5V		0.0008	0.013	%/V	
Load Regulation	ΔV _{OUT} /ΔI _{OUT}	Sourcing: 0 ≤ I _{OUT} ≤ 1mA		0.012	0.078	%mA	
		Sourcing: 1mA ≤ I _{OUT} ≤ 5mA		0.014	0.1		
		Sinking: -1mA ≤ I _{OUT} ≤ 0		0.005	0.12		
		Sinking: -5mA ≤ I _{OUT} ≤ -1mA		0.005	0.12		
OUT Short-Circuit Current	I _{SC}	Short to GND		33		mA	
		Short to IN		32			
Dropout Voltage (Notes 5, 9)	V _{IN} - V _{OUT}	I _{SOURCE} = 1mA, V _{OUT} = 5V		40	100	mV	
		I _{SOURCE} = 5mA, V _{OUT} = 5V		190	410		
Thermal Hysteresis (Note 3)	ΔV _{OUT} /cycle			421		ppm	
Long-Term Stability	ΔV _{OUT} /time	1000h at T _A = +25°C		133		ppm	
DYNAMIC							
Noise Voltage (Note 10)	e _{OUT}	f = 0.1Hz to 10Hz		6		μV _{P-P}	
		f = 10Hz to 1kHz		15		μV _{RMS}	
Turn-On Settling Time	t _R	To V _{OUT} = 0.1% of final value, C _{OUT} = 0.02μF	Initial power-up	360		μs	
			V _{IN} = 5V, $\overline{\text{SHDN}}$ pulled from low to high	75			
Output Impedance when Disabled (Note 11)	Z _{OUT}	V _{IN} = 5V, $\overline{\text{VSHDN}}$ = 0V		>10		MΩ	
Capacitive-Load Stability Range (Note 4)	C _{OUT}		0.02		1	μF	
INPUT							
Supply Voltage Range	V _{IN}	Guaranteed by line regulation test	2.5		5.5	V	
Quiescent Supply Current	I _{IN}			200	250	μA	
Shutdown Supply Current	I _{SHDN}	V _{SHDN} = 0V		0.15	500	nA	
ADJ Input Bias Current (Note 4)	I _{ADJ}		-50	0.5	+50	nA	

Low-Power, Fixed and Adjustable Reference with Shutdown in SOT23

ELECTRICAL CHARACTERISTICS—MAX6037_ADJ ($V_{OUT} = 1.184V$ to $5V$) (continued)

($V_{IN} = V_{SHDN} = +5V$, $I_{OUT} = 0$, $T_A = T_{MIN}$ to T_{MAX} , ADJ shorted to OUT unless otherwise noted. Typical values are at $T_A = +25^\circ C$.) (Note 1)

PARAMETER	SYMBOL	CONDITIONS	MIN	TYP	MAX	UNITS
SHUTDOWN (\overline{SHDN})						
Logic-High Input Voltage	V_{ENH}	$2.5V \leq V_{IN} \leq 5.5V$	2.0			V
Logic-Low Input Voltage	V_{ENL}	$2.5V \leq V_{IN} \leq 5.5V$			0.7	V
Logic-High Input Current	I_{ENH}	$2.5V \leq V_{IN} \leq 5.5V$, $V_{SHDN} = V_{IN}$	-1000	0.15	+1000	nA
Logic-Low Input Current	I_{ENL}	$2.5V \leq V_{IN} \leq 5.5V$, $V_{SHDN} = 0V$	-1000	0.05	+1000	nA

Note 1: All devices are 100% tested at $T_A = +25^\circ C$ and are guaranteed by design for $T_A = T_{MIN}$ to T_{MAX} , as specified.

Note 2: Temperature coefficient is measured by the "box" method, i.e., the maximum $\Delta V_{OUT} / V_{OUT}$ is divided by the maximum ΔT .

Note 3: Thermal hysteresis is defined as the change in $+25^\circ C$ output voltage before and after cycling the device from T_{MAX} to T_{MIN} .

Note 4: Not production tested. Guaranteed by design.

Note 5: Dropout voltage is defined as the minimum differential voltage ($V_{IN} - V_{OUT}$) at which V_{OUT} decreases by 1% from its original value at $V_{IN} = +5.0V$.

Note 6: V_{OUT} initial accuracy for the MAX6037_ADJ is tested with ADJ shorted to OUT. Actual accuracy will be affected by matching and the temperature coefficient of the external resistors used. Use 1% resistors with low temperature coefficient for best overall accuracy.

Note 7: The temperature coefficient for the MAX6037_ADJ is specified for the case where ADJ is connected to OUT. For the case where an external resistive network is used to set the output voltage, actual change in reference output over temperature will be affected by the temperature coefficient and matching of the external resistors used.

Note 8: The minimum V_{IN} is the greater of $+2.5V$ and $(V_{OUT} + 0.2V)$.

Note 9: V_{OUT} set to $+5V$ with an external resistive-divider.

Note 10: Noise for the MAX6037_ADJ is specified for a $+1.25V$ output. Noise is proportional to V_{OUT} and is greater for higher output voltages. In addition, external resistors used to set the output voltage can contribute to noise.

Typical Operating Characteristics

($V_{IN} = +3V$ for the MAX6037_12 and MAX6037_21; $V_{IN} = +5V$ for the MAX6037_25, MAX6037_30, MAX6037_33, and MAX6037_41; $I_{OUT} = 0$, $C_{OUT} = 0.1\mu F$, $C_{IN} = 0.1\mu F$, $T_A = +25^\circ C$, unless otherwise specified.)

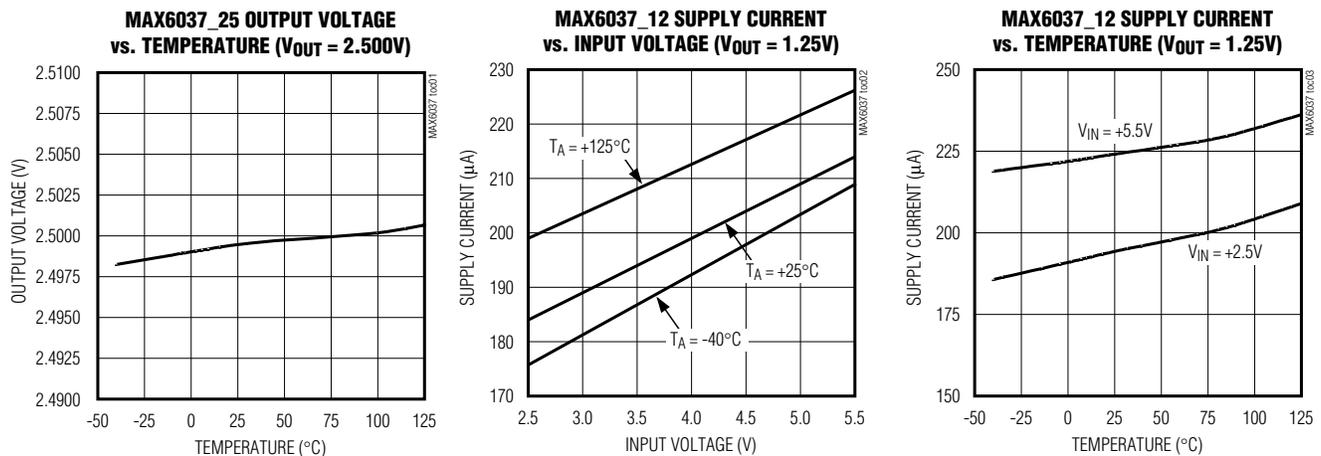

Low-Power, Fixed and Adjustable Reference with Shutdown in SOT23

MAX6037

Typical Operating Characteristics (continued)

($V_{IN} = +3V$ for the MAX6037_12 and MAX6037_21; $V_{IN} = +5V$ for the MAX6037_25, MAX6037_30, MAX6037_33, and MAX6037_41; $I_{OUT} = 0$, $C_{OUT} = 0.1\mu F$, $C_{IN} = 0.1\mu F$, $T_A = +25^\circ C$, unless otherwise specified.)

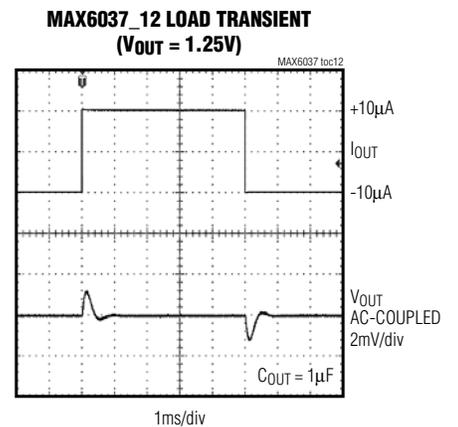
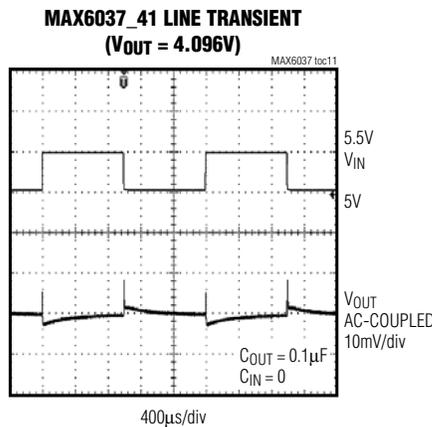
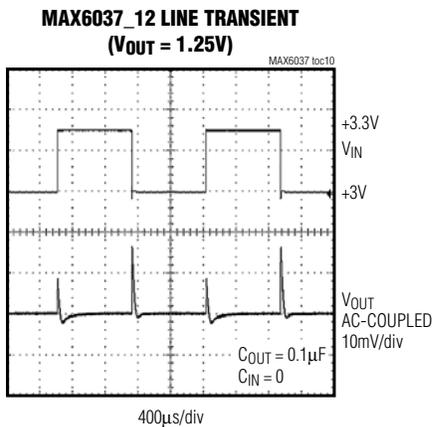
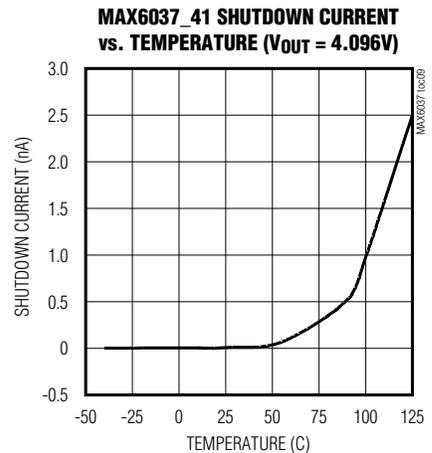
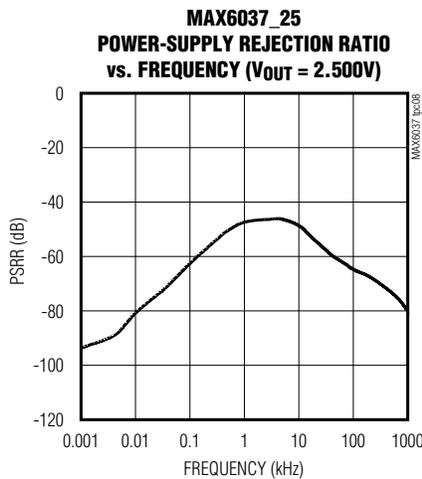
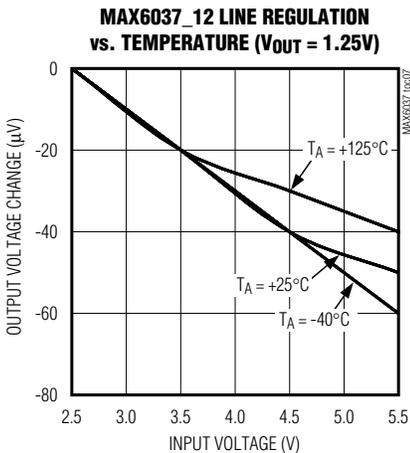
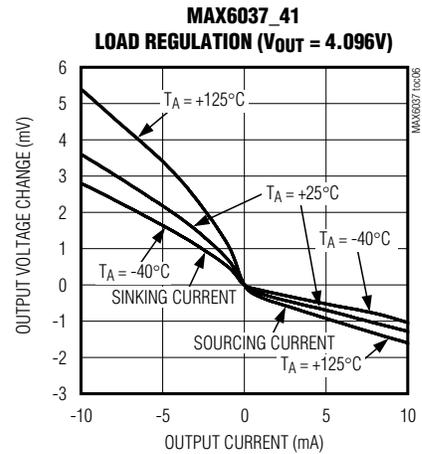
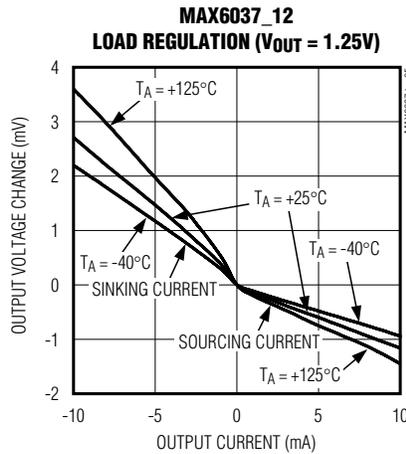
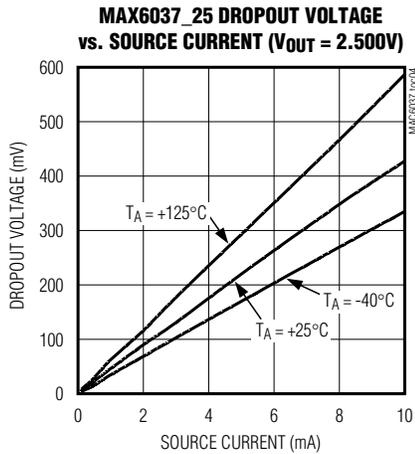

Low-Power, Fixed and Adjustable Reference with Shutdown in SOT23

Typical Operating Characteristics (continued)

($V_{IN} = +3V$ for the MAX6037_12 and MAX6037_21; $V_{IN} = +5V$ for the MAX6037_25, MAX6037_30, MAX6037_33, and MAX6037_41; $I_{OUT} = 0$, $C_{OUT} = 0.1\mu F$, $C_{IN} = 0.1\mu F$, $T_A = +25^\circ C$, unless otherwise specified.)

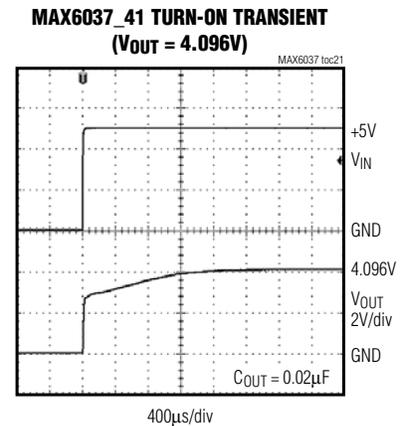
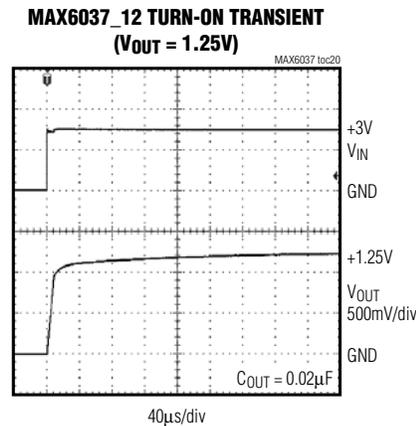
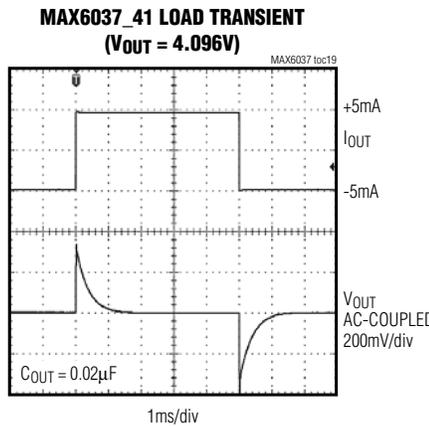
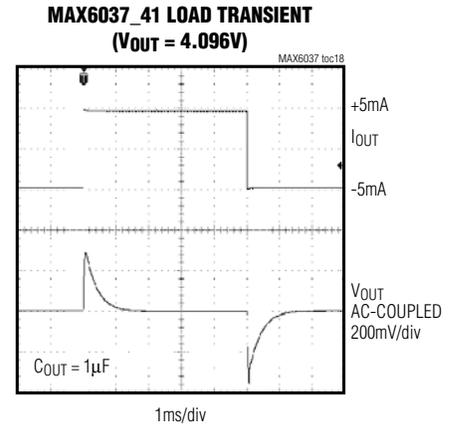
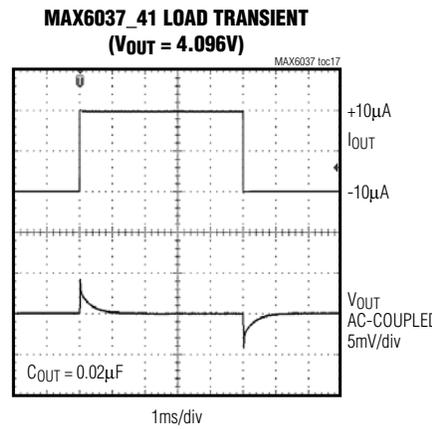
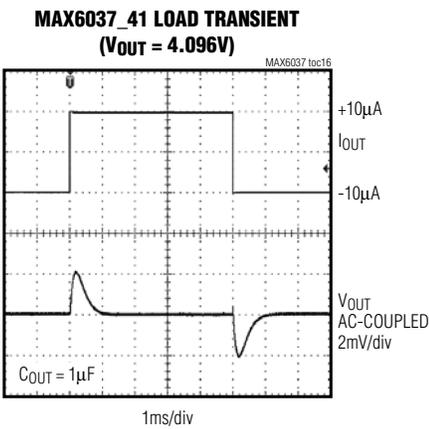
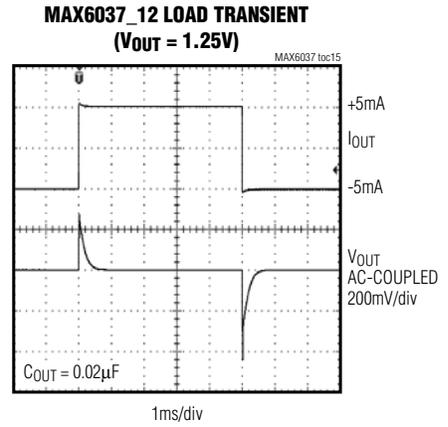
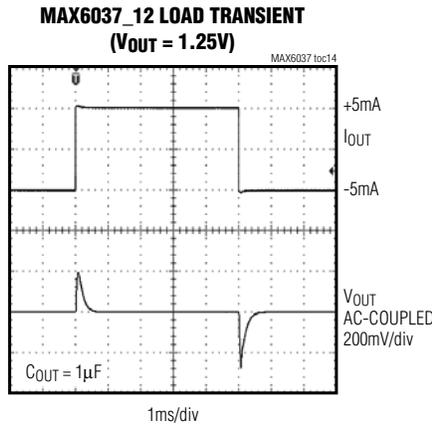
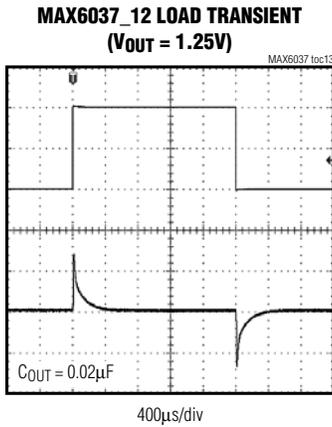

Low-Power, Fixed and Adjustable Reference with Shutdown in SOT23

MAX6037

Typical Operating Characteristics (continued)

($V_{IN} = +3V$ for the MAX6037_12 and MAX6037_21; $V_{IN} = +5V$ for the MAX6037_25, MAX6037_30, MAX6037_33, and MAX6037_41; $I_{OUT} = 0$, $C_{OUT} = 0.1\mu F$, $C_{IN} = 0.1\mu F$, $T_A = +25^\circ C$, unless otherwise specified.)

MAX6037_12 SHUTDOWN TRANSIENT
($V_{OUT} = 1.25V$)

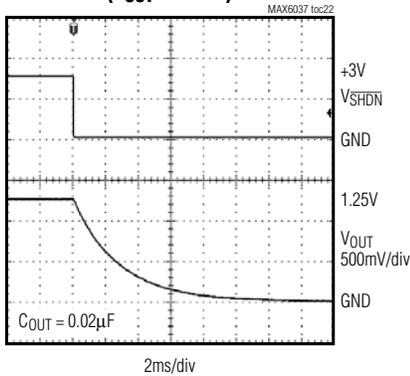

MAX6037_12 EXITING SHUTDOWN TRANSIENT
($V_{OUT} = 1.25V$)

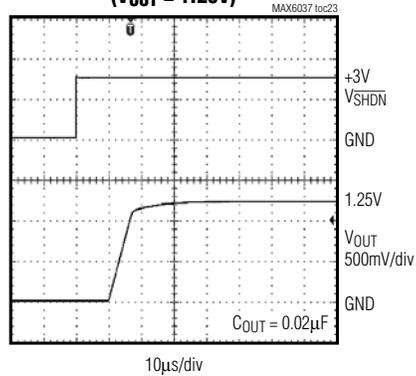

MAX6037_41 SHUTDOWN TRANSIENT
($V_{OUT} = 4.096V$)

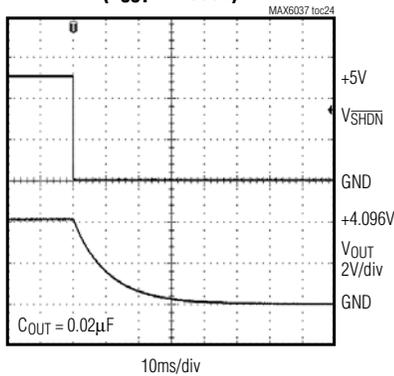

MAX6037_41 EXITING SHUTDOWN TRANSIENT
($V_{OUT} = 4.096V$)

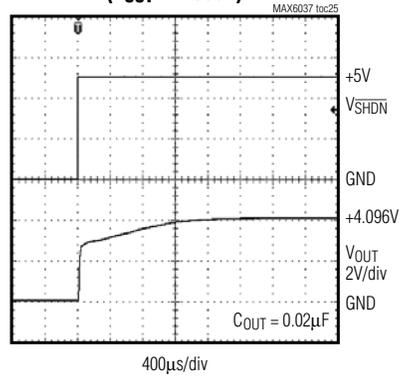

MAX6037_25 LONG-TERM STABILITY vs. TIME ($V_{OUT} = 2.500V$)

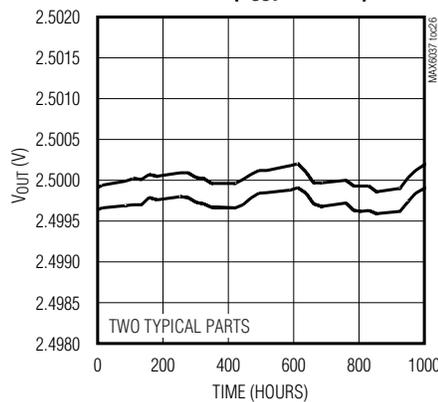

Low-Power, Fixed and Adjustable Reference with Shutdown in SOT23

Typical Operating Characteristics (continued)

($V_{IN} = +3V$ for the MAX6037_12 and MAX6037_21; $V_{IN} = +5V$ for the MAX6037_25, MAX6037_30, MAX6037_33, and MAX6037_41; $I_{OUT} = 0$, $C_{OUT} = 0.1\mu F$, $C_{IN} = 0.1\mu F$, $T_A = +25^\circ C$, unless otherwise specified.)

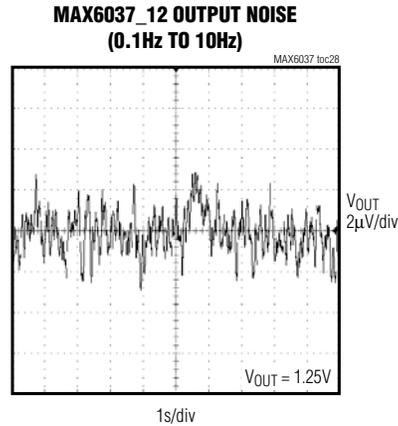
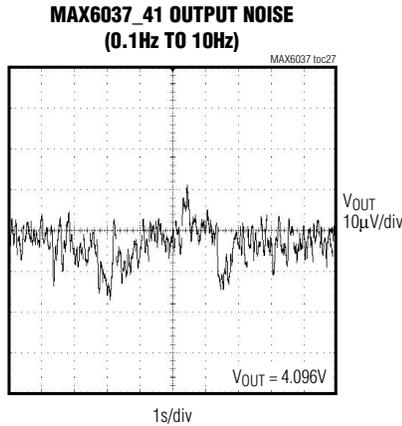

Note 12: Many of the MAX6037 family *Typical Operating Characteristics* are extremely similar. The extremes of these characteristics are found in the MAX6037_12 (1.25V output) and the MAX6037_41 (4.096V output). The *Typical Operating Characteristics* of the remainder of the MAX6037 family typically lie between those two extremes and can be estimated based on their output voltages.

Pin Description

PIN	NAME	FUNCTION
1	I.C.	Internally connected. (All fixed output voltage options.) Do not connect anything to this pin.
	ADJ	Output Voltage Adjustment Connection. Connect a resistor-divider between OUT, ADJ and GND to set the output voltage. (MAX6037_ADJ only).
2	GND	Ground
3	$\overline{\text{SHDN}}$	Active-Low Shutdown Input. Pull $\overline{\text{SHDN}}$ low to disable the device. Connect $\overline{\text{SHDN}}$ to IN for normal operation.
4	IN	Supply Voltage Input. Bypass with a 0.1µF to 1µF capacitor to GND.
5	OUT	Reference-Voltage Output. Connect an output capacitor to GND in the 0.02µF to 1µF range.

Pin Configuration

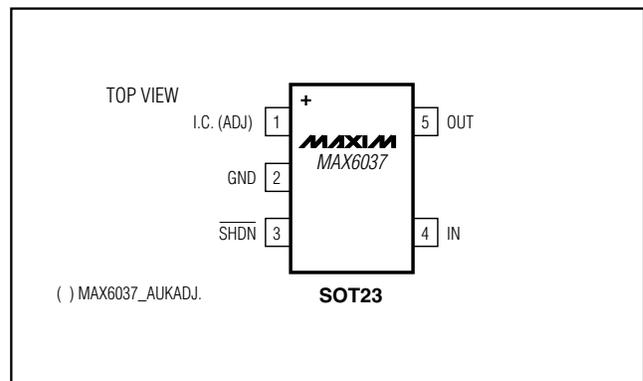

Low-Power, Fixed and Adjustable Reference with Shutdown in SOT23

Detailed Description

The MAX6037 is a family of low-dropout, micropower voltage references. These devices all feature a shutdown mode by forcing $\overline{\text{SHDN}}$ low, dropping the quiescent current to less than 500nA. The MAX6037 can sink and source up to 5mA with less than 410mV of dropout voltage, making them attractive for use in low-voltage applications. The MAX6037 is available in six fixed output voltages of 1.25V, 2.048V, 2.5V, 3.0V, 3.3V and 4.096V, and an adjustable output version for voltages between the range of 1.184V and 5V.

Shutdown

The MAX6037 features an active-low shutdown mode. Pulling $\overline{\text{SHDN}}$ low disables the output and forces the quiescent current to less than 500nA (typically 50pA). Connect $\overline{\text{SHDN}}$ to IN for normal operation.

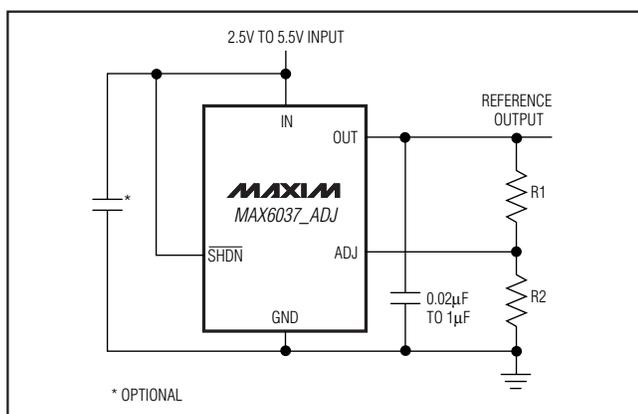

Figure 1. MAX6037_ADJ Typical Operating Circuit

MAX6037_ADJ Adjustable Output Voltage

Set the output voltage on the MAX6037_ADJ by placing a resistor-divider network between OUT, ADJ, and GND (See Figure 1). Use the following formula to calculate the output voltage:

$$V_{\text{OUT}} = \left(1 + \frac{R1}{R2}\right)V_{\text{ADJ}}$$

where $V_{\text{ADJ}} = 1.184\text{V}$. Set $R2 = 1\text{M}\Omega$ or less. Currents through Resistor R1 and R2 add to the quiescent supply current.

Supply Current

The quiescent supply current of the series-mode MAX6037 family is typically 190µA to 210µA. When the supply voltage is below the minimum-specified input voltage during turn-on, the device can draw up to 250µA beyond the nominal supply current. The input voltage source must be capable of providing this current to ensure reliable turn-on.

Thermal Hysteresis

Output voltage hysteresis is the change of output voltage at $T_A = +25^\circ\text{C}$ before and after the device is cycled over its entire operating temperature range. The typical thermal hysteresis value is 500ppm.

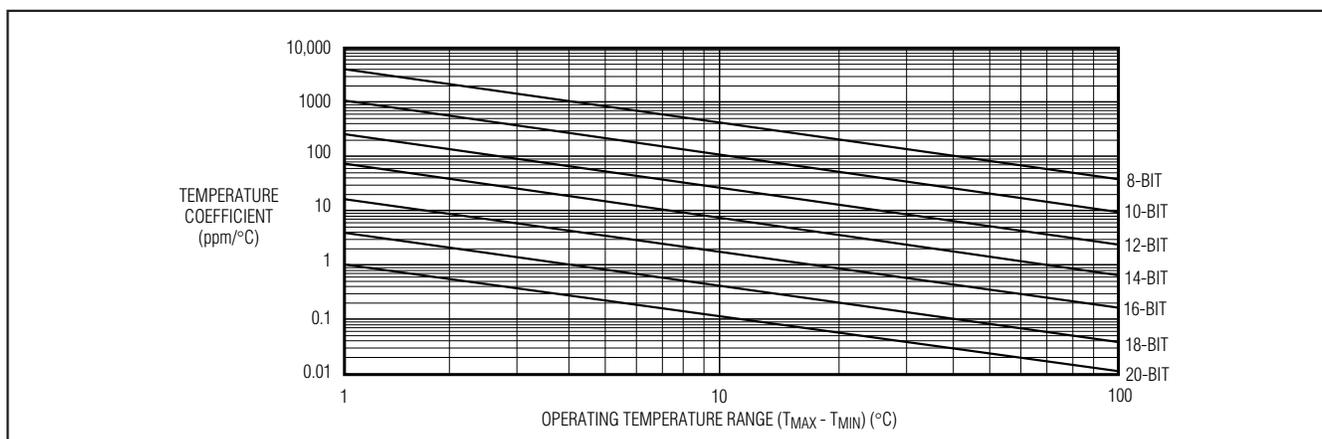

Figure 2. Temperature Coefficient vs. Operating Temperature Range for a 1 LSB Maximum Error

Low-Power, Fixed and Adjustable Reference with Shutdown in SOT23

Turn-On Time

These devices typically turn on and settle to within 0.1% of their final value in 360 μ s to 3.2ms, depending on the device. The turn-on time can increase up to 10ms with the device operating at the minimum dropout voltage and the maximum capacitive load.

Applications Information

Input Bypassing

For the best transient performance, decouple the input with a 0.1 μ F to 1 μ F ceramic capacitor as shown in the *Typical Operating Circuit*. Locate the capacitor as close to IN as possible. No capacitor is necessary if transient performance is less important.

Output/Load Capacitance

Devices in the MAX6037 family require an output capacitance in the range of 0.02 μ F to 1 μ F for frequency stability.

Temperature Coefficient vs. Operating Temperature Range for a 1 LSB Maximum Error

In a data converter application, the reference voltage of the converter must stay within a certain limit to keep the error in the data converter smaller than the resolution limit throughout the operating temperature range. Figure 2 shows the maximum allowable reference voltage temperature coefficient to keep the conversion error to less than 1 LSB, as a function of the operating temperature range ($T_{MAX} - T_{MIN}$) with the converter resolution as a parameter. The graph assumes the reference voltage temperature coefficient as the only parameter affecting accuracy.

In reality, the absolute static accuracy of a data converter is dependent on the combination of many parameters such as integral nonlinearity, differential nonlinearity, offset error, gain error, as well as voltage reference changes.

Ordering Information/Selector Guide (continued)

PART	OUTPUT VOLTAGE (V)	INITIAL ACCURACY %	MAX TEMPCO (ppm/°C)	PIN-PACKAGE	PKG CODE	TOP MARK
MAX6037AAUK25+T	2.5	0.2	25	5 SOT23-5	U5-2	AEJB
MAX6037BAUK25+T	2.5	0.3	50	5 SOT23-5	U5-2	AEJC
MAX6037CAUK25+T	2.5	0.5	50	5 SOT23-5	U5-2	AEJD
MAX6037AAUK30+T	3.0	0.2	25	5 SOT23-5	U5-2	AEJE
MAX6037BAUK30+T	3.0	0.3	50	5 SOT23-5	U5-2	AEJF
MAX6037CAUK30+T	3.0	0.5	50	5 SOT23-5	U5-2	AEJG
MAX6037AAUK33+T	3.3	0.2	25	5 SOT23-5	U5-2	AEJH
MAX6037BAUK33+T	3.3	0.3	50	5 SOT23-5	U5-2	AEJI
MAX6037CAUK33+T	3.3	0.5	50	5 SOT23-5	U5-2	AEJJ
MAX6037AAUK41+T	4.096	0.2	25	5 SOT23-5	U5-2	AEJK
MAX6037BAUK41+T	4.096	0.3	50	5 SOT23-5	U5-2	AEJL
MAX6037CAUK41+T	4.096	0.5	50	5 SOT23-5	U5-2	AEJM
MAX6037AAUKADJ+T**	1.184 to 5, adjustable	0.2	25	5 SOT23-5	U5-2	AEIS
MAX6037BAUKADJ+T**	1.184 to 5, adjustable	0.3	50	5 SOT23-5	U5-2	AEIT
MAX6037CAUKADJ+T**	1.184 to 5, adjustable	0.5	50	5 SOT23-5	U5-2	AEIU

**The accuracy of the MAX6037_ADJ is dependent on the accuracy of the external resistors. Use 1% resistors with low temperature coefficient for best overall accuracy.

+Denotes a lead-free package.

T = Tape and reel.

Note: All devices are specified over the -40°C to +125°C operating temperature range.

Chip Information

TRANSISTOR COUNT: 372

PROCESS: BiCMOS

Low-Power, Fixed and Adjustable Reference with Shutdown in SOT23

Package Information

(The package drawing(s) in this data sheet may not reflect the most current specifications. For the latest package outline information go to www.maxim-ic.com/packages.)

MAX6037

SOT-23 5L EPS

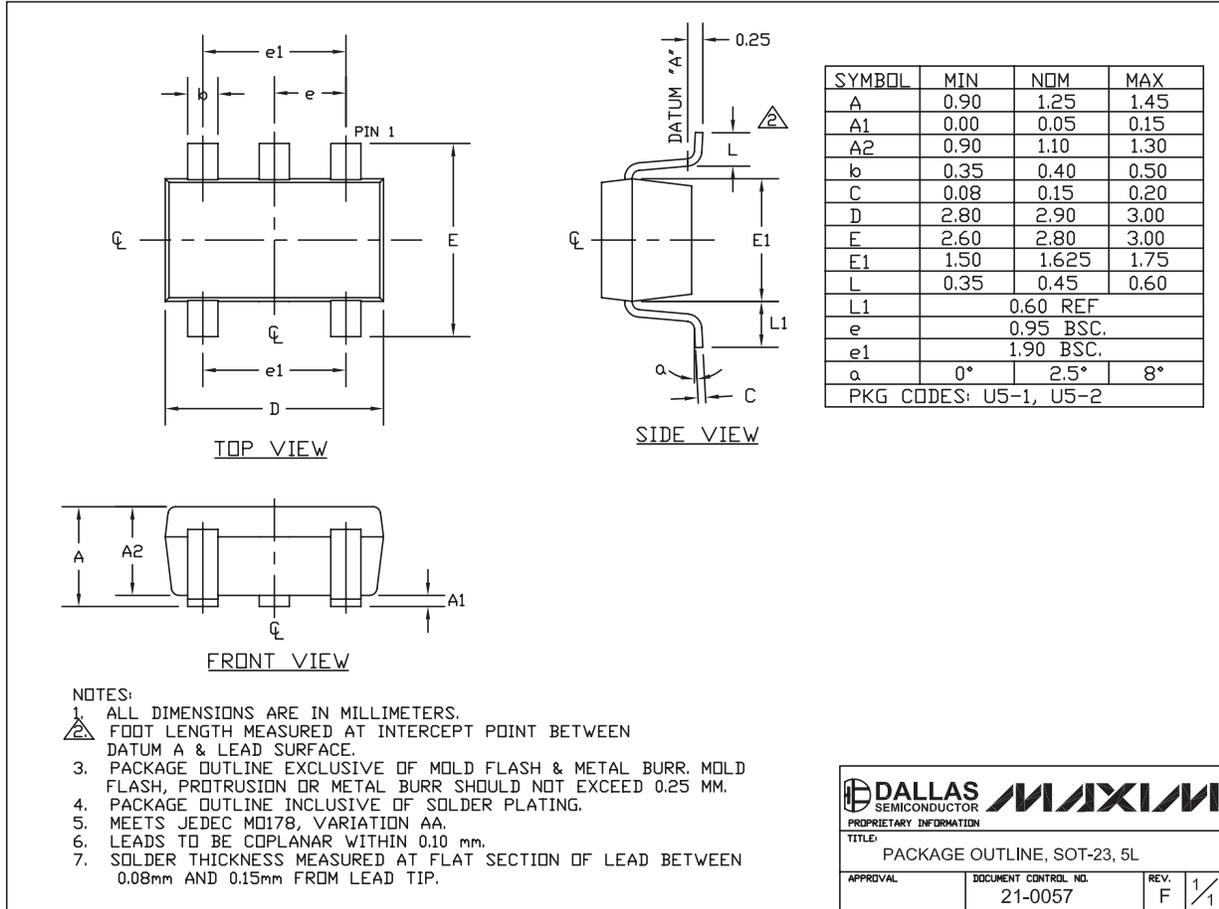

Low-Power, Fixed and Adjustable Reference with Shutdown in SOT23

Revision History

REVISION NUMBER	REVISION DATE	DESCRIPTION	PAGES CHANGED
0	2/04	Initial release	—
1	12/07	Updating selector table	1-7, 9, 16

Maxim cannot assume responsibility for use of any circuitry other than circuitry entirely embodied in a Maxim product. No circuit patent licenses are implied. Maxim reserves the right to change the circuitry and specifications without notice at any time.

18 _____ **Maxim Integrated Products, 120 San Gabriel Drive, Sunnyvale, CA 94086 408-737-7600**

Mouser Electronics

Authorized Distributor

Click to View Pricing, Inventory, Delivery & Lifecycle Information:

Maxim Integrated:

[MAX6037AAUK12+T](#) [MAX6037AAUK21+T](#) [MAX6037AAUK30+T](#) [MAX6037AAUK33+T](#) [MAX6037AAUK41+T](#)
[MAX6037BAUK12+T](#) [MAX6037BAUK21+T](#) [MAX6037BAUK25+T](#) [MAX6037BAUK30+T](#) [MAX6037BAUK33+T](#)
[MAX6037BAUK41+T](#) [MAX6037BAUKADJ+T](#) [MAX6037CAUK12+T](#) [MAX6037CAUK21+T](#) [MAX6037CAUK25+T](#)
[MAX6037CAUK30+T](#) [MAX6037CAUK33+T](#) [MAX6037CAUK41+T](#) [MAX6037CAUKADJ+T](#) [MAX6037AAUK25+T](#)
[MAX6037AAUKADJ+T](#)