

MAX25603 Evaluation Kit

Evaluates: MAX25603

General Description

The MAX25603 evaluation kit (EV kit) provides a proven design to evaluate the MAX25603 automotive high-voltage, high-brightness LED buck-boost controller. The EV kit operates from a 5V to 60V DC supply voltage. The EV kit is configured to deliver up to 1A to one or two strings of 1 to 15 LEDs. The total voltage of each string can vary from 0V to 60V. The anode of the LED strings should go to LED1+ or LED2+ terminals and the cathodes to the GND terminal. Shunting FETs are provided to emulate a combination headlamp in which a single LED string can contain the clearance lamp (CLL), low beam (LB), and high beam (HB) all in one. Each can be independently turned on or off by shorting across the appropriate segments of the LED string.

Features

- 5V to 60V Input Voltage Range
- Demonstrates Use in Combination Headlamps and Multistring, Time-Sharing Applications
- Analog and Digital Dimming Control
- Input Current Limit
- LED Current Clamp Function
- Output Discharge for Faster Transient Time
- LED Short and Open Protection
- Proven PCB Layout
- Fully Assembled and Tested

[Ordering Information](#) appears at end of data sheet.

EV Kit Photo



Quick Start

Required Equipment

- MAX25603 EV kit
- 12V, 5A DC power supply
- Signal generator
- Series-connected LED strings rated to at least 1.5A
- Oscilloscope with a current probe

Procedure

The EV kit is fully assembled and tested. Use the following steps below to verify board operation:

Caution: Do not turn on power supply until all connections are made. Be sure not to violate power ratings if modifying component values.

1. Verify that all jumpers are in their default positions, as shown in [Table 1](#).
2. Connect the positive terminal of the 12V supply to VINP1 and the negative terminal to the PGND.
3. Connect the anode a LED string to LED1+ and the cathode to GND on the EV kit.
4. Clip the current probe on the wire connected to the LED string.
5. Turn on the DC power supply.
6. Apply 5V to EN1.
7. Verify that the LEDs turn on.
8. Adjust potentiometer R3 until the LED current is approximately 1A.

Table 1. Jumper Connection Guide

JUMPER	SHUNT POSITION	FEATURE
J1	Open	Apply an external DC voltage between 0.2V to 1.2V for setting the LED current.
	Closed	Uses the resistive divider from VCC and the potentiometer R3 to set the LED current.
J2	Open	Uses the resistive divider from VCC and the potentiometer R3 to set the LED current.
	1-2	R4 is placed in series with R3 to lower the LED current when EN2 is high.
	2-3	R4 is placed in series with R3 to lower the LED current when EN1 is high.
J3	Open	Apply an external 0 to 5V signal on the SHUNT pin.
	1-2	SHUNT pin is tied to VCC. The error amplifier will always be connected to COMP2.
	2-3	SHUNT pin is tied to GND. The error amplifier will always be connected to COMP1.
J4	Open	Apply an external 0 to 5V PWM clock source for PWM dimming on Q6.
	1-2	EN2 pin pulled to VCC for 100% duty on Q6.
	2-3	EN2 pin pulled to GND to turn off Q6.
J5	Open	Apply an external 0 to 5V PWM clock source for PWM dimming on Q5.
	1-2	EN1 pin pulled to VCC for 100% duty on Q5.
	2-3	EN1 pin pulled to GND to turn off Q5.
J6	Open	Disconnects the source of shunting FET Q7 from LED2+.
	Closed	Connects the source of shunting FET Q7 to LED2+.
J7	Open	Disconnects the drain of shunting FET Q7 from LB+.
	Closed	Connects the drain of shunting FET Q7 to LB+.
J8	Open	Overvoltage protection threshold is set by the resistive divider from VOUTCAP.
	1-2	R49 is placed in parallel with R46 and lowered the overvoltage protection threshold when EN2 is high.
	2-3	R49 is placed in parallel with R46 and lowered the overvoltage protection threshold when EN1 is high.
J10	Open	LED2+ LEDs are driven through the Q6.
	Closed	Bypasses Q6. Use to compare performance without the LED current clamp.
J11	Open	LED1+ LEDs are driven through Q5.
	Closed	Bypasses Q5. Use to compare performance without the LED current clamp.

Default options appear in bold.

Setup and Operation

1. Verify that all jumpers are in their default positions, as shown in [Table 1](#).
2. Connect the positive terminal of the 12V supply to VINP1 and the negative terminal to the PGND.
3. Connect the anode a LED string to LED1+ and the cathode to GND on the EV Kit.
4. Clip the current probe on the wire connected to the LED string.
5. Turn on the DC power supply.
6. Apply 5V to EN1.
7. Verify that the LEDs turn on.
8. Adjust potentiometer R3 until the LED current is approximately 1A.

Clearance Lamp (CCL), Low Beam (LB), High Beam (HB)

Shunting FETs Q7, Q9, Q10, and Q11 are provided to emulate an application in which a single MAX25603 device can drive the clearance lamp, daytime running lamps, low beam, and high beam functions all from a single LED string. The following procedure describes how to configure this EV kit to drive the LED configuration shown in [Typical Application Circuit](#).

9. With jumper J6 closed, connect the daytime running lamp LEDs between LED2+ and DRL-. The clearance lamp LEDs are connected between DRL- and LB.
10. Short LED1+ to LB+. The low beam LEDs are connected between LB+ and HB. The high beam LEDs are connected between HB and GND.
11. Controlling each individual segment is done by driving the gates of the appropriate shunting FETs high or low. The clearance lamp and daytime running lamps can be dimmed simultaneously by applying a 5V 200Hz PWM signal at EN1. While EN1 is low, EN2 must be high to conduct the clearance and daytime running lamps. A level shifter is provided for driving the gate of the Q7 pMOS.
12. Apply a 5V signal to the gate of Q8 to turn the daytime running lamps off. If desired, the SHUNT pin can be tied to EN1. When SHUNT is low, the error amplifier of the MAX25603 uses the compensation network on COMP1. COMP2 is connected to the error amplifier when SHUNT is high. Using the SHUNT pin also enables the output discharge feature.

Detailed Description of Hardware

This evaluation kit should be used with the following documents:

- MAX25603 data sheet
- MAX25603 EV kit data sheet (this document)

These documents, or links to them, are included on the MAX25603 EV kit package. For the latest versions of the documents listed above, use the following link: www.maximintegrated.com/MAX25603

EN1 and EN2—PWM Dimming

EN1 and EN2 are input signals that control GTP1 and GTP2, respectively, as well as the switching of MAX25603. If both EN1 and EN2 are low, the MAX25603 is in the off state. If both EN1 and EN2 are high, EN1 has priority, and GTP1 is on while GTP2 is off. PWM dimming can be achieved on either channel by keeping the respective jumper J4 or J5 open and applying an external PWM signal to either EN1 or EN2. Move either jumper to position 1-2 keeps that channel on 100% and moving that jumper to 2-3 keeps that channel off. If simultaneously toggling between EN1 and EN2, ensure that there is at least a 1μs deadtime between the falling edge of one EN and the rising edge of the other EN. For the typical application circuit in Figure 1, keep EN2 high and toggle EN1 to implement PWM dimming on the CLL and DRL LEDs.

Analog Dimming Control (ICTRL)

When J1 is closed, the LED current is set by resistive divider from VCC. The equation to set the LED current is:

$$I_{LED} = (V_{ICTRL} - 200mV) / (5 \times R24 || R25)$$

Use a screwdriver to turn the potentiometer R3 to adjust ICTRL. If ICTRL is greater than 1.3V, the LED current is limited to:

$$I_{LED} = 1.1V / (5 \times R24 || R25)$$

For time sharing applications in which EN1 and EN2 are alternately dimmed, a different LED current setting can be desired on each string. R4 and Q1 are provided to lower the programmed current. Place jumper J2 in position 1-2 for a lower LED current on the EN2 or in position 2-3 for a lower LED on the EN1 string. By default, J2 is open and the LED current is the same for both strings.

LED Current Clamp and Output Discharge

When closing any of the shunting FETs, the total LED string voltage is initially too high that causes the LEDs to conduct a large amount of current until the output capacitor decreases to the appropriate value for the desired programmed current. A unique feature with the MAX25603 is the ability to drive the PMOS on GTP1 and GTP2 as linear current clamps to limit the LED current and protect the LEDs. This clamp level is set to 25% greater than the current set by ICTRL. If the current clamp is triggered concurrently to a rising edge on the SHUNT pin, the MAX25603 switches in a hysteretic mode to provide negative inductor current and discharge the output capacitor back to the supply. The LED current clamp improves robustness of the system while utilizing the dual compensation and output discharge of SHUNT pin greatly improves transient performance.

Input-Current Limit

The MAX25603 features circuitry that limits the input current during line dropouts. Refer to the MAX25603 IC data sheet for details on setting the input current limit. The input current is given by the following equation:

$$I_{N_{MAX}} = \frac{0.1}{RN1 || RN2}$$

This circuitry can be disabled by replacing RN1 and RN2 with 0Ω resistors.

Open LED

The MAX25603 features an adjustable overvoltage threshold used for open LED detection. The threshold is determined by the voltage divider on the FB pin and is given by the following equation:

$$V_{OVP} = 1.24 \times \frac{R45 + R46}{R46}$$

The overvoltage threshold level should be set to approximately 25% above the expected LED forward voltage. When driving the LEDs with a very narrow PWM duty cycle, overvoltage may not be detected if the overvoltage level is set too high and the output cannot slew up to it within the PWM on-time. This can arise when driving two strings with a largely different number of LEDs. R49 and Q3 are provided as way to lower the threshold. By default, J8 is open and the overvoltage threshold is set to 35V for both EN1 and EN2. Select an appropriate value for R49 and short jumper J8 between 1-2 or 2-3 depending on if either EN1 or EN2 requires the lower threshold.

When an open is detected, switching stops and FLT is pulled low. Switching resumes only when the voltage on the FB drops by 70mV and EN1 or EN2 is high. FLT goes high only if EN1 or EN2 is high and V(ISP-ISP) is greater than 20mV.

Short LED

A short-circuit condition across the LED string is detected when the voltage on ISP falls below 4.7V for at least 10ms. After 10ms the regulation point of the voltage across the LED current-sense resistor is determined by the lower of 320mV or ICTRL. A short-circuit does not assert FLT. The short-circuit condition is cleared when ISP rises above 4.8V.

Typical Application Circuit

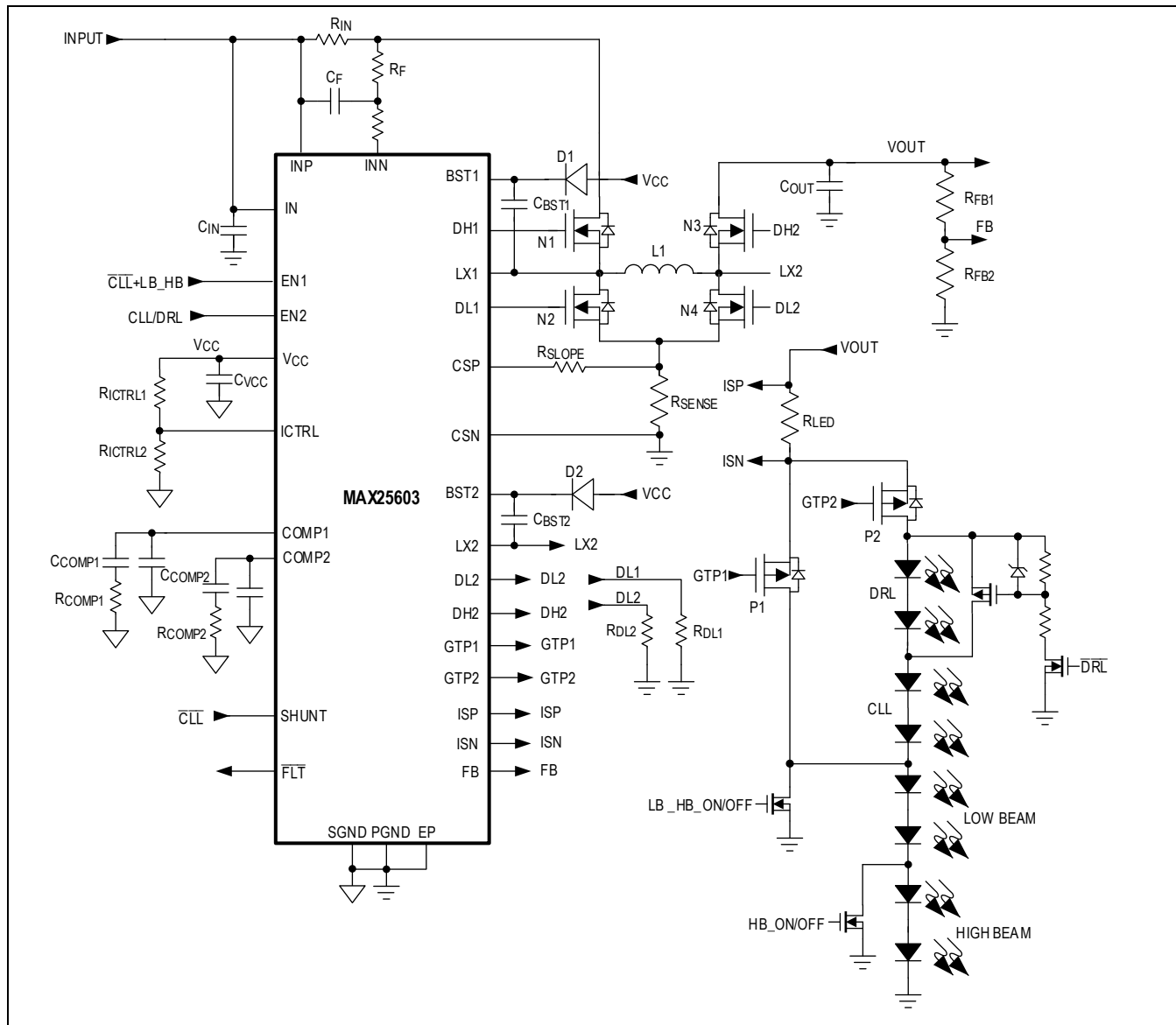

Ordering Information

PART	TYPE
MAX25603EVKIT#	EV Kit

#Denotes RoHS compliance.

MAX25603 EV Kit Bill of Materials

PART	QTY	DESCRIPTION
C1, C5, C17, C43	4	CAP; SMT (0603); 0.1UF; 10%; 50V; X7R; CERAMIC
C2, C3, C18-C20, C44	6	CAP; SMT (1206); 4.7UF; 10%; 50V; X7R; CERAMIC
C4	1	CAP; SMT (CASE_F); 68UF; 20%; 50V; ALUMINUM-ELECTROLYTIC
C6, C16, C21	3	CAP; SMT (0603); 0.1UF; 10%; 25V; X7R; CERAMIC
C7	1	CAP; SMT (0603); 2.2UF; 10%; 25V; X5R; CERAMIC
C8	1	CAP; SMT (0603); 1000PF; 5%; 100V; C0G; CERAMIC
C10, C31, C33	3	CAP; SMT (0603); 0.1UF; 10%; 100V; X7R; CERAMIC
C12	1	CAP; SMT (0603); 0.1UF; 10%; 35V; X7R; CERAMIC
C13-C15, C36-C41	9	CAP; SMT (0603); 1000PF; 5%; 50V; C0G; CERAMIC
C23, C24	2	CAP; SMT (0603); 2200PF; 5%; 50V; C0G; CERAMIC
C27	1	CAP; SMT (1210); 10UF; 10%; 100V; X7S; CERAMIC
C32, C34	2	CAP; SMT (0603); 0.01UF; 5%; 50V; C0G; CERAMIC
C35	1	CAP; SMT (0603); 100PF; 5%; 50V; C0G; CERAMIC
C42	1	CAP; SMT (0603); 470PF; 10%; 100V; X7R; CERAMIC
D1-D4, D7-D9, D11-D13	10	DIODE; SWT; SMT (SOD-123); PIV=100V; IF=0.3A; -65 DEGC TO +150 DEGC
D10	1	DIODE; ZNR; SMT (SOT23-3); VZ=12V; IZ=0.005A
FLTB, VCC	2	TEST POINT; PIN DIA=0.125IN; TOTAL LENGTH=0.35IN; BOARD HOLE=0.063IN; WHITE; PHOSPHOR BRONZE WIRE SILVER PLATE FINISH;
J1, J6, J7, J10, J11	5	CONNECTOR; MALE; THROUGH HOLE; BREAKAWAY; STRAIGHT THROUGH; 2PINS; -65 DEGC TO +125 DEGC
J2-J5, J8	5	CONNECTOR; MALE; THROUGH HOLE; BREAKAWAY; STRAIGHT THROUGH; 3PINS; -65 DEGC TO +125 DEGC
L1	1	INDUCTOR; SMT (1806); FERRITE-BEAD; 56 IMPEDANCE AT 100MHZ; 6A
L2	1	INDUCTOR; SMT; SHIELDED; 1UH; TOL=+/-20%; 11.1A
L3, L9-L11	4	INDUCTOR; SMT (1206); FERRITE-BEAD; 1000; TOL=25%; 2A
L7	1	INDUCTOR; SMT; FERRITE CORE; 10UH; TOL=+/-20%; 5.7A

L8	1	RES; SMT (0805); 0; JUMPER; JUMPER; 0.5000W
MTH1-MTH4	4	MACHINE FABRICATED; ROUND-THRU HOLE SPACER; NO THREAD; M3.5; 5/8IN; NYLON
Q1, Q3, Q8	3	TRAN; ; NCH; SOT-23; PD-(0.33W); IC-(0.5A); VCEO-(60V); -55 DEGC TO +150 DEGC
Q2, Q22	2	TRAN; DUAL N-CHANNEL POWER MOSFET; NCH; SO-8FL; PD-(19W); I-(26A); V-(60V)
Q5, Q6	2	TRAN; P-CHANNEL 60-V (D-S) MOSFET; PCH; POWERPAK1212-8; PD-(3.8W); I-(-5.7A); V-(-60V)
Q7	1	TRAN; AUTOMOTIVE P-CHANNEL MOSFET; PCH; SOT-23; PD-(2W); I-(-1.7A); V-(-60V)
Q9-Q11	3	TRAN; SMALL SIGNAL MOSFET; NCH; SOT-346; PD-(1W); IC-(3A); VDSS-(60V)
Q12	1	TRAN; NPN SMALL SIGNAL SURFACE MOUNT TRANSISTOR; NPN; SOT-23; PD-(0.3W); I-(0.5A); V-(80V)
R1	1	RES; SMT (0805); 1; 1%; +/-100PPM/DEGC; 0.1250W
R2, R7, R9-R11	5	RES; SMT (0603); 10K; 5%; +/-200PPM/DEGC; 0.0630W
R3	1	RESISTOR; THROUGH-HOLE-RADIAL LEAD; 3296 SERIES; 10K OHM; 10%; 100PPM; 0.5W; SQUARE TRIMMING POTENTIOMETER; 25 TURNS; MOLDER CERAMIC OVER METAL FILM
R4, R49	2	RES; SMT (0603); 806; 1%; +/-100PPM/DEGK; 0.1000W
R5	1	RES; SMT (0603); 100; 1%; 100PPM; 0.2500W
R6	1	RES; SMT (0603); 75; 1%; +/-100PPM/DEGC; 0.1000W
R8, R31, R36, R39, R42, R50	6	RES; SMT (0603); 1M; 1%; +/-100PPM/DEGC; 0.1000W
R12	1	RES; SMT (0603); 100; 0.10%; +/-25PPM/DEGC; 0.1000W
R13	1	RES; SMT (0603); 49.9; 1%; +/-100PPM/DEGC; 0.1000W
R14, R19, R26, R27, R43, R44	6	RES; SMT (0603); 0; JUMPER; JUMPER; 0.1000W
R15, R16, R21, R22	4	RES; SMT (0603); 5.62; 1%; +/-100PPM/DEGC; 0.1000W
R17, R20	2	RES; SMT (1206); 1.5; 5%; +600/-100PPMDEGC; 0.6600W
R18	1	RES; SMT (0603); 1.27K; 1%; +/-100PPM/DEGC; 0.1000W
R24, R25	2	RES; SMT (1206); 0.4; 1%; +/-300PPM/DEGC; 0.25W
R28	1	RES; SMT (0603); 2.49K; 1%; +/-100PPM/DEGC; 0.1000W

R29	1	RES; SMT (0603); 20K; 1%; +/-100PPM/DEGC; 0.1000W
R32-R34, R37, R40	5	RES; SMT (0603); 1K; 1%; +/-100PPM/DEGC; 0.1000W
R35, R38, R41	3	RES; SMT (0603); 4.22K; 1%; +/-100PPM/DEGC; 0.1000W
R45	1	RES; SMT (0603); 330K; 1%; +/-100PPM/DEGC; 0.1000W
R46	1	RES; SMT (0603); 12.1K; 1%; +/-100PPM/DEGC; 0.1000W
R47	1	RES; SMT (0603); 20K; 5%; +/-200PPM/DEGC; 0.1000W
R48	1	RES; SMT (0603); 30K; 1%; +/-100PPM/DEGC; 0.1000W
R51	1	RES; SMT (0603); 0; JUMPER; JUMPER; 0.2500W
RN1, RN2	2	RES; SMT (1206); 0.024; 1%; +/-150PPM/DEGC; 1W
RS1, RS2	2	RES; SMT (1206); 0.02; 1%; +/-75PPM/DEGC; 1W
SU1	1	TEST POINT; SHUNT AND JUMPER; STR; TOTAL LENGTH=6.10MM; BLACK; INSULATION=GLASS FILLED POLYESTER; CONTACT=PHOSPHOR BRONZE
TP1	1	CONNECTOR; PANELMOUNT; BINDING POST; STRAIGHT THROUGH; 1PIN; BLACK
TP2	1	CONNECTOR; PANELMOUNT; BINDING POST; STRAIGHT THROUGH; 1PIN; RED
U1	1	EVKIT PART - IC; MAX25603; AUTOMOTIVE FOUR-SWITCH BUCK-BOOST LED CONTROLLER FOR COMBINATION HEAD LIGHTS; TSSOP28-EP; PACKAGE CODE U28+1C; LAND PATTERN: 90-100069; PACKAGE OUTLINE DRAWING: 21-100182
PCB	1	PCB:MAX25603
C9, C11	0	CAP; SMT (0603); 1500PF; 10%; 50V; C0G; CERAMIC
C22	0	CAP; SMT (0603); 100PF; 5%; 100V; C0G; CERAMIC
C25	0	CAP; SMT (1210); 4.7UF; 10%; 100V; X7S; CERAMIC
C26	0	CAP; SMT (1210); 10UF; 10%; 100V; X7S; CERAMIC
C28, C29	0	CAP; SMT (1206); 0.022UF; 10%; 50V; X7R; CERAMIC
C30	0	CAP; SMT (1206); 1UF; 10%; 100V; X7R; CERAMIC
D5, D6	0	DIODE; SCH; SMA (DO-214AC); PIV=50V; IF=3A

R23	0	RES; SMT (0603); 3.3; 1%; +/-100PPM/DEGC; 0.1000W
-----	---	---

MAX25603 EV Kit Schematic

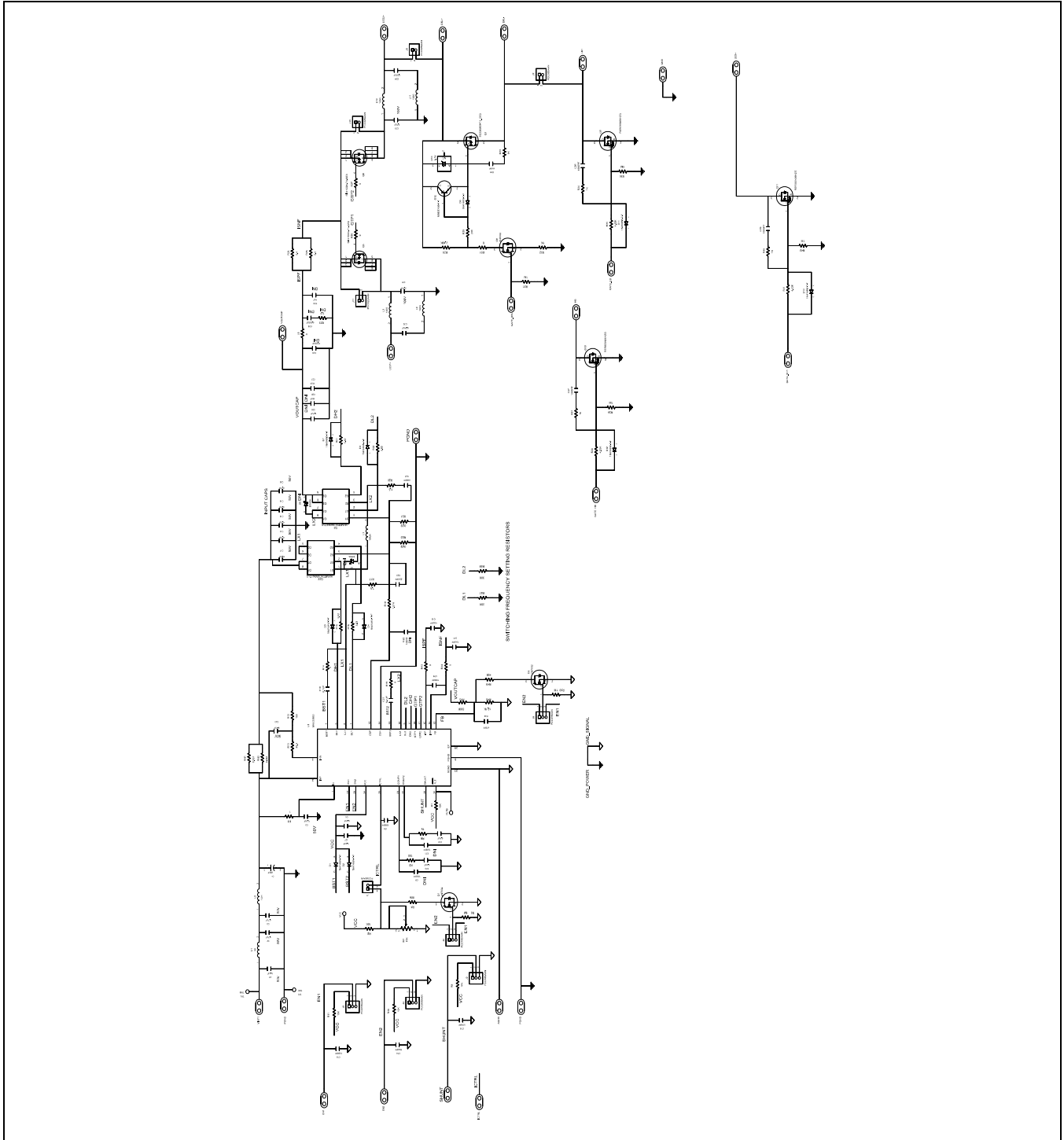

MAX25603 EV Kit PCB Layout

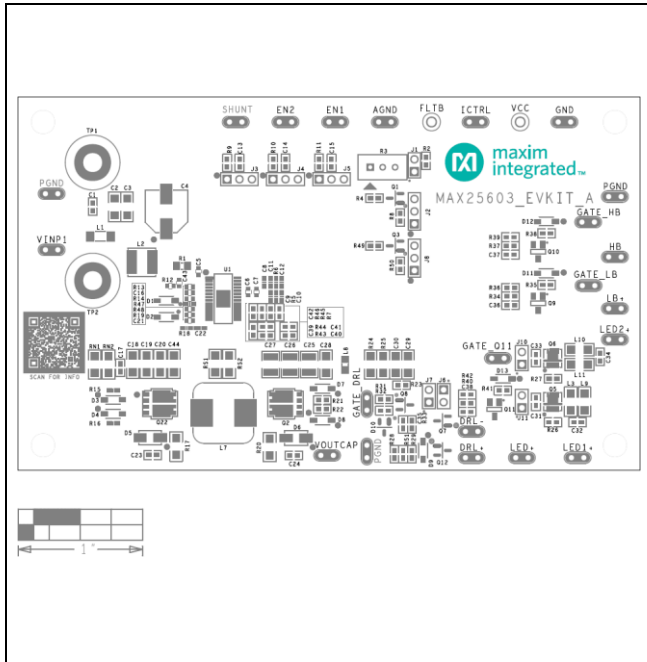

MAX25603 EV Kit Component Placement Guide—Top Silkscreen

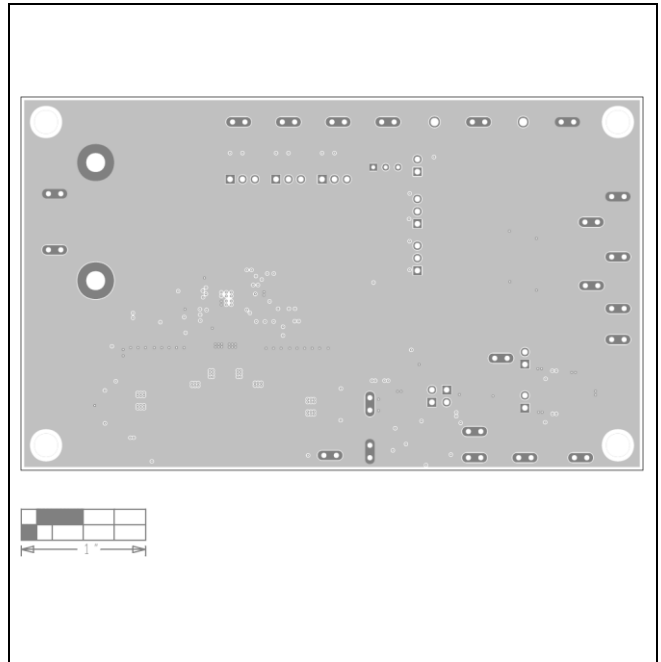

MAX25603 EV Kit PCB Layout—Layer 2

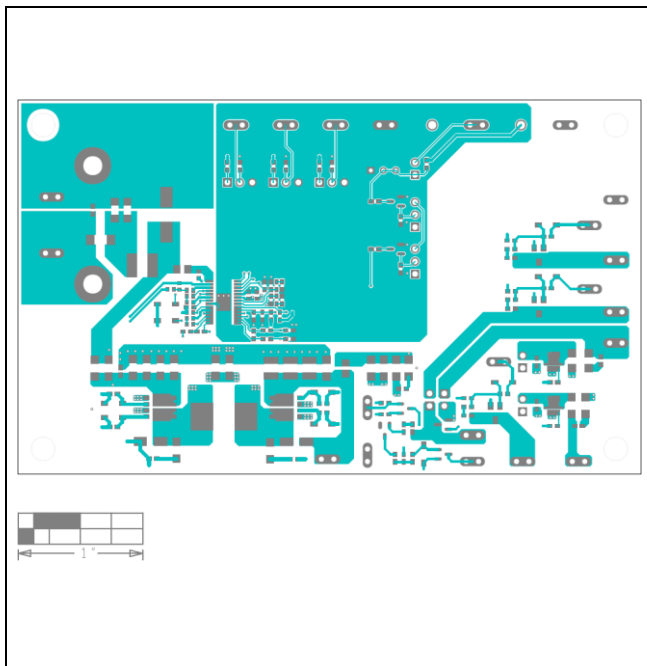

MAX25603 EV Kit PCB Layout—Top

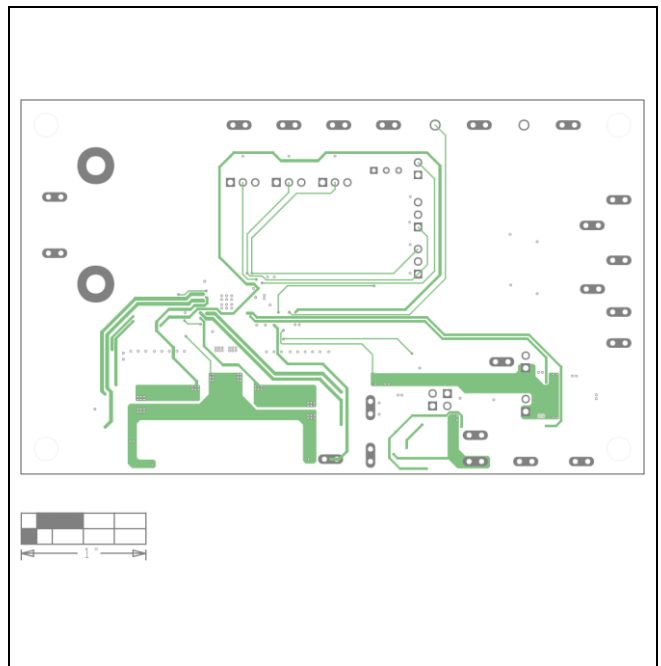

MAX25603 EV Kit PCB Layout—Layer 3

**MAX25603 EV Kit PCB Layout
(continued)**

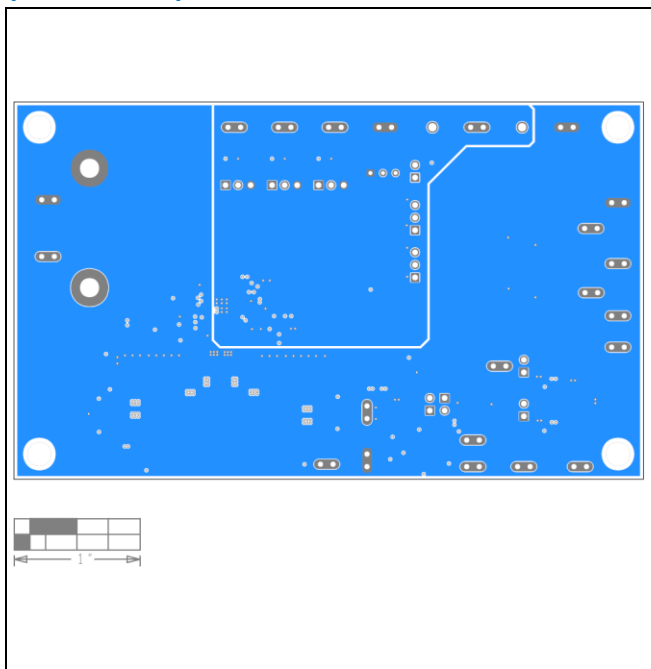

MAX25603 EV Kit PCB Layout—Bottom

Revision History

REVISION NUMBER	REVISION DATE	DESCRIPTION	PAGES CHANGED
0	12/21	Initial release	—

Mouser Electronics

Authorized Distributor

Click to View Pricing, Inventory, Delivery & Lifecycle Information:

[Maxim Integrated:](#)

[MAX25603EVKIT#](#)