

Features

- Integrated Logic
- Positive Single Control
- Insertion Loss: 2.0 dB @ 3.4 GHz
- IP3: >42 dBm typical @ 2.0 GHz
- Attenuation Accuracy: 0.3 dB + 3% @ 3.4 GHz
- 0.5 dB Attenuation Steps to 15.5 dB
- Lead-Free 3 mm 16-Lead PQFN Package
- Halogen-Free “Green” Mold Compound
- RoHS* Compliant and 260°C Re-flow Compatible

Description

M/A-COM’s MAADSS0018 is a 5-bit, 0.5-dB step GaAs MMIC digital attenuator in a lead-free 3mm 16 lead PQFN surface mount plastic package. The MAADSS0018 is ideally suited for use where high accuracy, very low power consumption and low intermodulation products are required. Typical applications include radio, cellular, wireless LANs, GPS equipment and other gain / level control circuits.

The MAADSS0018 is part of a digital attenuator family. This family includes 4, 5 and 6 bit attenuators with 0.5, 1 or 2 dB steps and up to 31.5 range.

Ordering Information ^{1,2}

Part Number	Package
MAADSS0018TR-1000	1000 piece reel
MAADSS0018TR-3000	3000 piece reel
MAADSS0018SMB	Sample Board

1. Reference Application Note M513 for reel size information.
2. All sample boards include 5 loose parts.

Functional Schematic ³

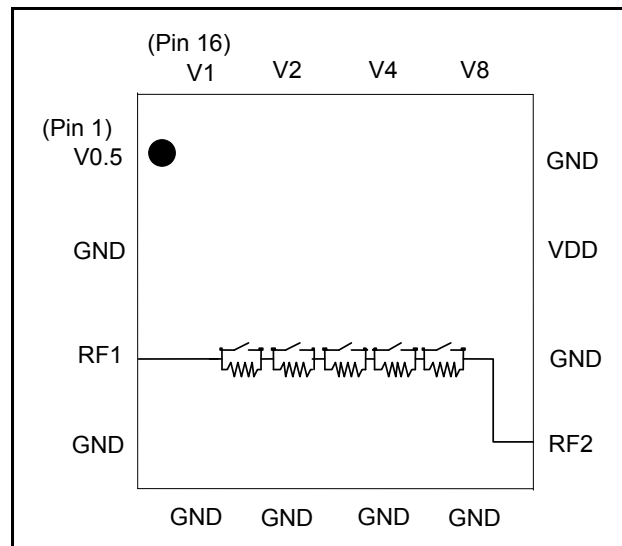

3. Blocking capacitors are required on all RF ports

Pin Configuration

Pin No.	Function	Pin No.	Function
1	V0.5 (0.5dB Bit)	9	RF In/Out
2	Ground	10	Ground
3	RF In/Out	11	VDD
4	Ground	12	Ground
5	Ground	13	V8 (8dB Bit)
6	Ground	14	V4 (4dB Bit)
7	Ground	15	V2 (2dB Bit)
8	Ground	16	V1 (1dB Bit)

* Restrictions on Hazardous Substances, European Union Directive 2002/95/EC.

Digital Attenuator, 5-Bit, Single Control 15.5 dB, 2.0 - 6.0 GHz

Rev. V1

Electrical Specifications ⁴: $T_A = 25^\circ\text{C}$, $Z_0 = 50\ \Omega$, $V_{DD} = 5\ \text{V}$, $V_C = 5\ \text{V}$

Parameter	Test Conditions	Units	Min.	Typ.	Max.
Reference Insertion Loss	3.4 GHz	dB	0.0	2.0	3.0
Attenuation Accuracy	3.4 GHz	$\pm (0.3\ \text{dB} + 3\% \text{ of attenuation setting in dB})\ \text{dB}$			
VSWR	2.0 - 6.0 GHz	Ratio	—	1.45:1	—
Trise, Tfall	10% to 90% RF, 90% to 10% RF	ns	—	50	—
Ton, Toff	50% Control to 90% RF, 50% Control to 10% RF	ns	—	50	—
Transients	In Band	mV	—	75	—
Input P1dB	2.0 GHz	dBm	—	25	—
IP ₂	2-Tone, +5 dBm/tone, 1 MHz Spacing 2.0 - 6.0 GHz	dBm	—	80	—
IP ₃	2-Tone, +5 dBm/tone, 1 MHz Spacing 2.0 - 6.0 GHz	dBm	—	42	—
I _C	$V_C = 5\ \text{V}$	μA	—	15	25
I _{DD}	$V_{DD} = 5\ \text{V}$	μA	—	225	300

4. External DC blocking capacitors are required on all RF ports.

Truth Table ⁵

VC0.5	VC1	VC2	VC4	VC8	Attenuation (dB)
0	0	0	0	0	Reference IL
1	0	0	0	0	0.5
0	1	0	0	0	1
0	0	1	0	0	2
0	0	0	1	0	4
0	0	0	0	1	8
1	1	1	1	1	15.5

5. 0 = 0 V, 1 = 2.8 to 5V

Absolute Maximum Ratings ^{6,7}

Parameter	Absolute Maximum
Input Power 2.0 - 6.0 GHz	+33 dBm
Control Voltage	$-0.5\ \text{V} \leq V_C \leq 5.5\ \text{V}$
Operating Temperature	-40°C to $+85^\circ\text{C}$
Storage Temperature	-65°C to $+150^\circ\text{C}$

6. Exceeding any one or combination of these limits may cause permanent damage to this device.

7. M/A-COM does not recommend sustained operation near these survivability limits.

Typical Performance Curves

Insertion Loss

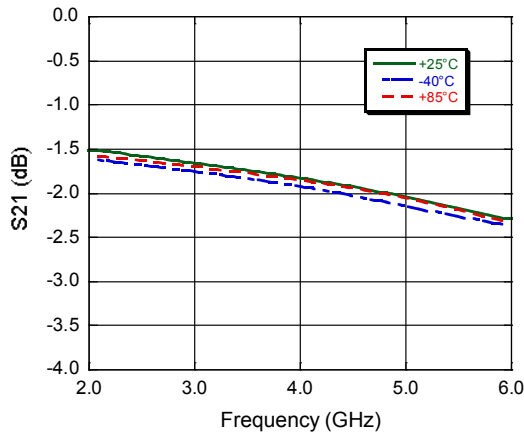

Relative Attenuation across all major states

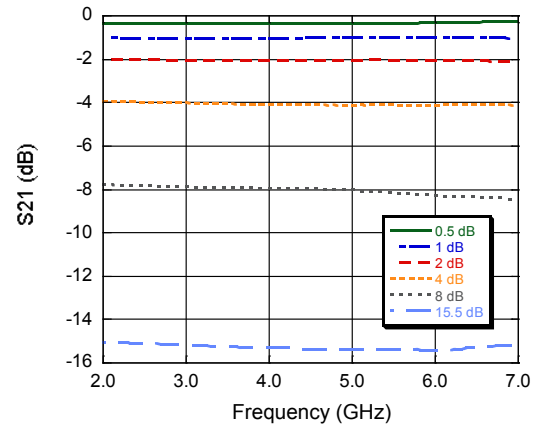

Return Loss, Insertion Loss State

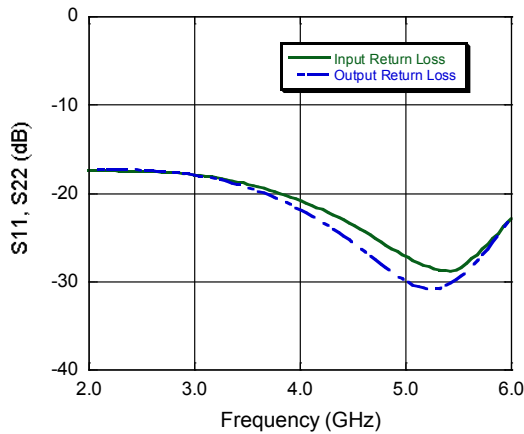

Input Return Loss, across all major attenuation states

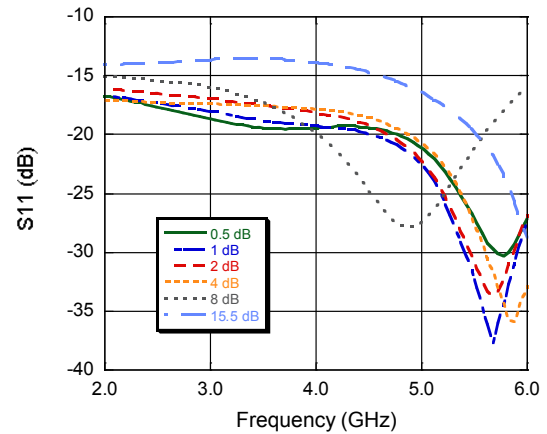

Step Error vs. State over Frequency

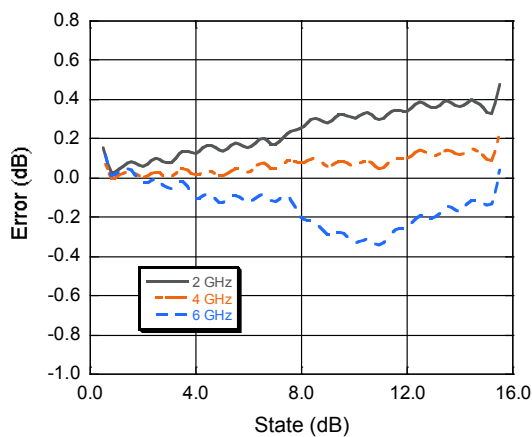

Output Return Loss, across all major attenuation states

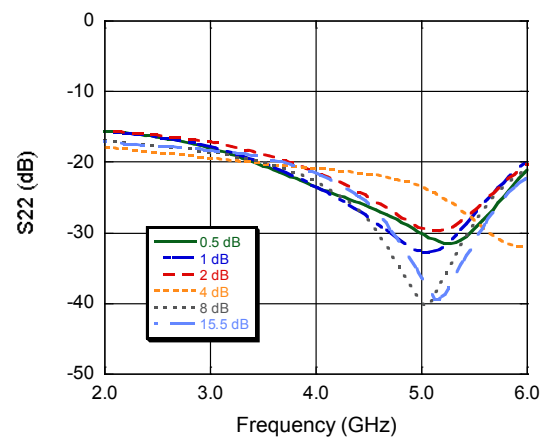

3
3

M/A-COM Technology Solutions Inc. All rights reserved.

Information in this document is provided in connection with M/A-COM Technology Solutions Inc ("MACOM") products. These materials are provided by MACOM as a service to its customers and may be used for informational purposes only. Except as provided in MACOM's Terms and Conditions of Sale for such products or in any separate agreement related to this document, MACOM assumes no liability whatsoever. MACOM assumes no responsibility for errors or omissions in these materials. MACOM may make changes to specifications and product descriptions at any time, without notice. MACOM makes no commitment to update the information and shall have no responsibility whatsoever for conflicts or incompatibilities arising from future changes to its specifications and product descriptions. No license, express or implied, by estoppel or otherwise, to any intellectual property rights is granted by this document.

THESE MATERIALS ARE PROVIDED "AS IS" WITHOUT WARRANTY OF ANY KIND, EITHER EXPRESS OR IMPLIED, RELATING TO SALE AND/OR USE OF MACOM PRODUCTS INCLUDING LIABILITY OR WARRANTIES RELATING TO FITNESS FOR A PARTICULAR PURPOSE, CONSEQUENTIAL OR INCIDENTAL DAMAGES, MERCHANTABILITY, OR INFRINGEMENT OF ANY PATENT, COPYRIGHT OR OTHER INTELLECTUAL PROPERTY RIGHT. MACOM FURTHER DOES NOT WARRANT THE ACCURACY OR COMPLETENESS OF THE INFORMATION, TEXT, GRAPHICS OR OTHER ITEMS CONTAINED WITHIN THESE MATERIALS. MACOM SHALL NOT BE LIABLE FOR ANY SPECIAL, INDIRECT, INCIDENTAL, OR CONSEQUENTIAL DAMAGES, INCLUDING WITHOUT LIMITATION, LOST REVENUES OR LOST PROFITS, WHICH MAY RESULT FROM THE USE OF THESE MATERIALS.

MACOM products are not intended for use in medical, lifesaving or life sustaining applications. MACOM customers using or selling MACOM products for use in such applications do so at their own risk and agree to fully indemnify MACOM for any damages resulting from such improper use or sale.

5
5

M/A-COM Technology Solutions Inc. (MACOM) and its affiliates reserve the right to make changes to the product(s) or information contained herein without notice.
Visit www.macom.com for additional data sheets and product information.

Mouser Electronics

Authorized Distributor

Click to View Pricing, Inventory, Delivery & Lifecycle Information:

[MACOM:](#)

[MAADSS0018](#) [MAADSS0018T-1000](#) [MAADSS0018TR](#)