

LSP05G Module Series





Description

Littelfuse's LSP05G thermally protected surge protection device specially designed to be used in outdoor, commercial, and industrial LED lighting fixtures. It utilizes Littelfuse's thermally protected varistor technology which acts as a self-protector, helping prevent end-of-life issues related to varistors as well as issues related to sustaining over-voltage conditions. It also provides high line-to-earth/ground resistance, facilitating faster production line testing.

LSP05G series connected option allows clear indication of thermal fault protection by disconnecting power to luminaire, thereby signaling SPD module replacement. The LSP05G Surge Protective Device facilitates customer's product compliance to IEEE C62.41.2 Location Category C Low ANSI C136.2 and US Dept. of Energy MSSLC Model Spec.

Agency Approvals

Agency	Standard	Agency File Number
	UL1449+ for 120V, 240V, 277V Only	E320116
	IEC 61643-11**	NL-37684 and NL-40516

+ = For 120V, 240V and 277V
 ++ = For 240V and 277V, respectively

Applications

- Outdoor and Commercial LED Lighting
- Roadway lighting
- Traffic lighting
- Digital signage
- Wall wash lighting
- Parking garage lighting
- Flood lighting
- Tunnel lighting
- Street lighting
- Industrial high-bay and low-bay lighting

Additional Information



Datasheet



Resources



Samples

Features

- Maximum Discharge Current (I_{max}) 10kA, 8/20 μ s
- Meets ANSI C136.2 Enhanced Level 10kV/5kA, IEEE C62.41.2 Location Category C Low Exposure and US Dept. of Energy MSSLC Model Spec.
- Thermally Protected Varistor technology
- Parallel and Series Connected SPD Options
- IP66 Water-proof and Dust-proof
- UL1449 Recognized (120Vac, 240Vac and 277Vac only)
- Series- connected option for 240V and 277V is IEC 61643-11 Test Class II and EN 61643-11 Type 2 compliant.
- IEC CB Scheme Certificate NL-37684 available for 240V and NL-40516 for 277V
- Compact form factor with mounting tabs
- 240Vac and 277Vac are CE compliant and available for Class I and Class II installation based on IEC luminaire protection classes
- Series connected – Varistor thermal protection indication by removal of power to luminaire
- High line-to-earth/ground resistance
- RohS compliant

Absolute Maximum Ratings

• For ratings of individual members of a series, see Device Ratings and Specifications chart

	LSP05G Series	Units
Continuous:		
Max AC Voltage Range ($V_{MIACRMS}$)	150 to 510	V
Continuous Current	5	A
Transient:		
Maximum Discharge Current, 8/20 μ s Waveform (I_{max})	10,000	A
Nominal Discharge Current, 8/20 μ s Waveform (I_n)	5,000	A
Operating Ambient Temperature Range (T_A)	-45 to +85	°C
Storage Temperature Range (T_{STG})	-45 to +90	°C
Isolation Voltage Capability (When the thermal disconnect opens)	600	V
Insulation Resistance	>1,000	M Ω

CAUTION: Stresses above those listed in "Absolute Maximum Ratings" may cause permanent damage to the device. This is a stress only rating and operation of the device at these or any other conditions above those indicated in the operational sections of this specification is not implied.

LSP05G Series Device Ratings & Specifications

Part Number	Operating Voltage (VAC)	MCOV/U _c ¹ (VAC)	Maximum Discharge Current ² I _{max} (A)	Nominal Discharge Current ³ I _n (A)	Typical MLV ⁴ (V)	Typical U _p ⁵ (V)	Safety Compliance	
							IEC/EN 61643-11 ^{6 & 7}	UL1449
LSP05G120*	120	150	10,000	5,000	L-N:600 L-G:1410 N-G:1410	L-N:700 L-G:1600 N-G:1600		X
LSP05G240*	240	275	10,000	5,000	L-N:970 L-G:1410 N-G:1410	L-N:1100 L-G:1600 N-G:1600	X	X
LSP05G277*	277	320	10,000	5,000	L-N: 1130 L-G: 1410 N-G:1410	L-N: 1200 L-G: 1600 N-G:1600	X	X
LSP05G347*	347	420	10,000	5,000	L-N: 1530 L-G: 1550 N-G: 1410	L-N: 1600 L-G: 1700 N-G: 1600		
LSP05G480*	480	510	10,000	5,000	L-N: 1800 L-G: 1900 N-G: 1410	L-N: 2100 L-G: 2000 N-G: 1600		
LSP05G480*H†	480	510	10,000	5,000	L-N: 1800 L-G: 3090 N-G: 3090	L-N: 2100 L-G: 3700 N-G: 3700		

* = S or P

† with 1500Vac Hi-Pot withstand capability in common mode (L-G and N-G)

Glossary:

1. MCOV/U_c: Maximum Continuous Operating Voltage - maximum r.m.s. voltage that could be continuously applied to the SPD.
2. Maximum Discharge Current I_{max}(A): The maximum discharge current is a measure of the SPDs maximum capability; single impulse of discharge current uses the 8/20µs current waveform. All Devices pass maximum discharge current with possible, safe opening of thermal disconnect.
3. Nominal Discharge Current I_n (A): The nominal discharge current is a measure of the SPDs endurance capability; 15 impulses of discharge current uses the 8/20µs current waveform.
4. MLV: UL1449 Measured limiting voltage; the highest value of residual voltage measurements during the application of impulses of 8/20µs nominal discharge current (I_n); an average voltage value of 15 impulses
5. U_p: IEC 61643-11 Voltage protection level; the highest value of residual voltage measurements during the application of impulses of 8/20µs nominal discharge current (I_n); a rounding voltage value of maximum measurement.
6. Series module used in parallel connection for indication circuit connection.
7. LSP05G240S & LSP05G277S are certified by DEKRA with below IEC 61643-11 specifications

LSP05G240S Specification	Parameter	Value	Unit	Condition
Temporary overvoltage TOV	U _T	337	V	LV system fault 255 V x 1.32 at t _T = 5 s, TN power grid
Temporary overvoltage TOV	U _T	442	V	LV system fault 255 V x 1.732 at t _T = 120 min, TN power grid
Power grids		TN		
Backup fuse		16	A	max., gG fuse
End of life indication		yes		Optical, light ON: SPD is functional Light OFF: SPD has reached end-of-life
Max earth leakage current at U _c		50	µA	Max. rms, to GND

LSP05G277S Specification	Parameter	Value	Unit	Condition
Temporary overvoltage TOV	U _T	403	V	LV system fault 305 V x 1.32 at t _T = 5 s, TN power grid
Temporary overvoltage TOV	U _T	529	V	LV system fault 305 V x 1.732 at t _T = 120 min, TN power grid
Power grids		TN		
Backup fuse		20	A	max., gG fuse
End of life indication		yes		Optical, light ON: SPD is functional Light OFF: SPD has reached end-of-life

Repetitive Surge Capability

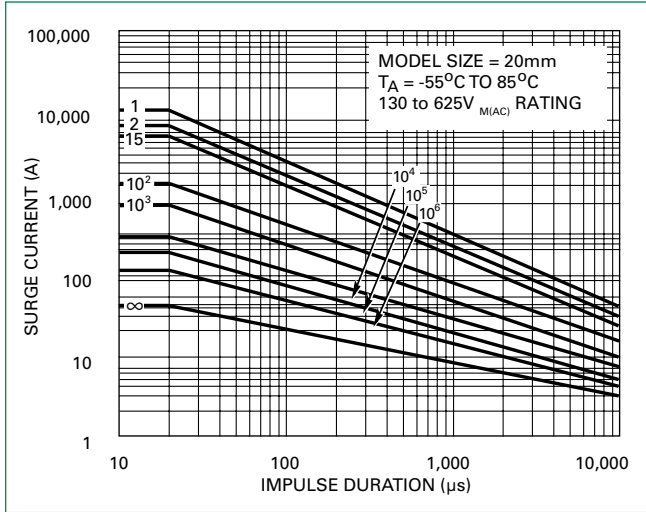

Pulse Rating (8x20µSec)	
Strikes	Surge
1	10,000A
2	7,000A
15	5,000A
100	1,500A
1,000	700A

Dimensions

Series Version

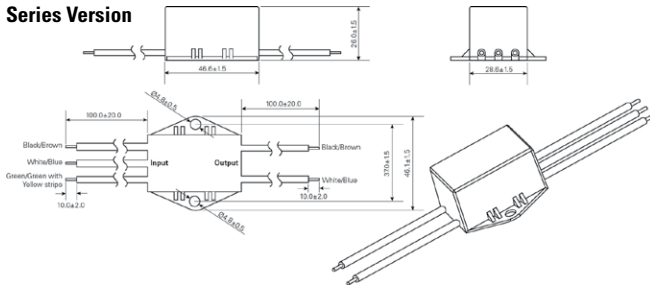

Parallel Version

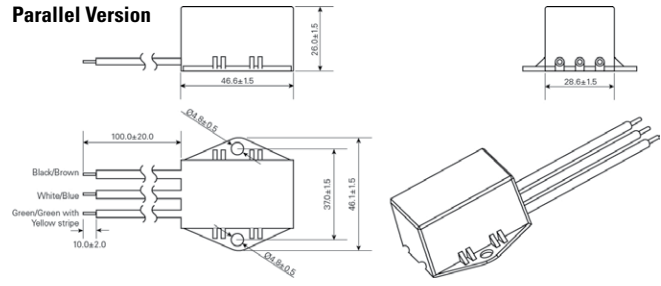

Notes:

1. Black: Line; White: Neutral; Green: Ground.
(P/N with suffix X3333/X3316: Brown: Line; Blue: Neutral; Green-Yellow stripe: Ground)
2. Wire Gauge: AWG16, wire length: 100mm±20mm, wire stripping length: 10±2mm.
3. Caution: Line/neutral wires must be correctly connected to AC power grid. Wiring error on line/neutral polarity may cause module failure.

Application/Installation Schematic

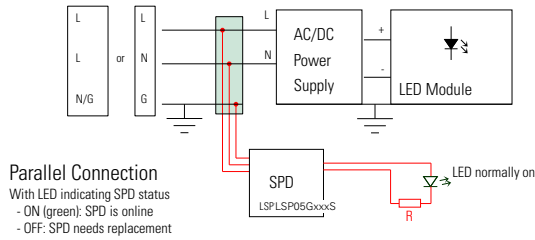
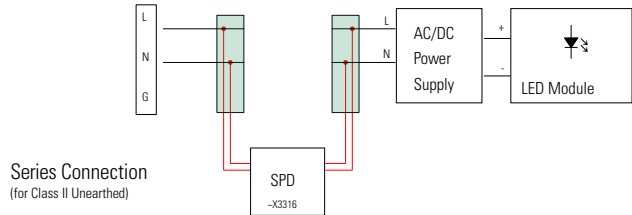
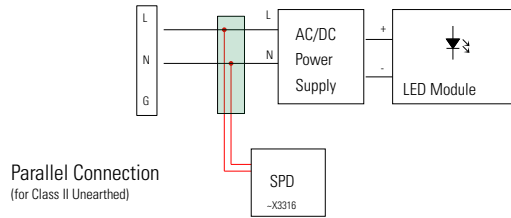
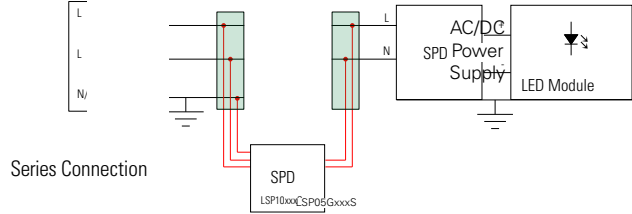
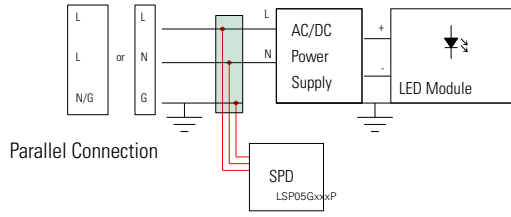

Notes:

1. Series module used in parallel connection for indication circuit connection.
2. LED indicator and associated circuitry are not included in the module.
3. Black wire is AC line voltage (hot); white wire is AC neutral voltage.
4. Black wire voltage is cut off when SPD needs replacement.
5. R is current limiting resistor; its resistance/wattage is determined by AC line voltage and desired current driving LED. Example: AC line voltage 240V, LED: 1.6mA, resistor:150kOhm/0.5W.

Part Numbering System

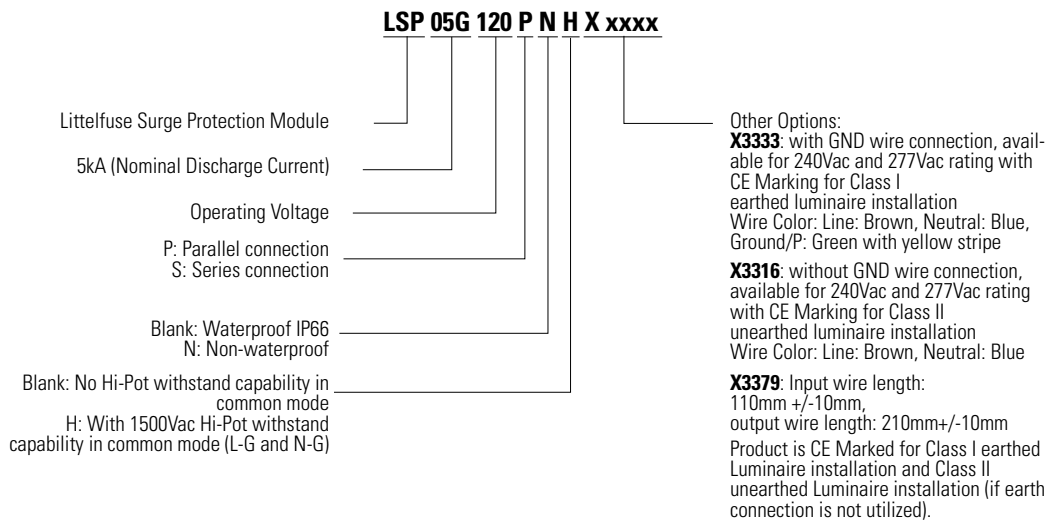

Disclaimer Notice - Information furnished is believed to be accurate and reliable. However, users should independently evaluate the suitability of and test each product selected for their own applications. Littelfuse products are not designed for, and may not be used in, all applications. Read complete Disclaimer Notice at www.littelfuse.com/disclaimer-electronics.

Mouser Electronics

Authorized Distributor

Click to View Pricing, Inventory, Delivery & Lifecycle Information:

Littelfuse:

[LSP05G277PX3333](#) [LSP05G277PX3316](#) [LSP05G240PX3333](#) [LSP05G240PX3316](#) [LSP05G277SX3333](#)
[LSP05G277SX3316](#) [LSP05G240SX3316](#) [LSP05G240SX3333](#) [LSP05G240S](#) [LSP05G277S](#) [LSP05G240P](#)
[LSP05G277P](#) [LSP05G347P](#) [LSP05G347S](#) [LSP05G277SN](#) [LSP05G480P](#) [LSP05G120S](#) [LSP05G120P](#)
[LSP05G277PN](#) [LSP05G480PN](#) [LSP05G277PH](#) [LSP05G277PL250](#) [LSP05G480SN](#) [LSP05G480PH](#) [LSP05G120PN](#)
[LSP05G120SN](#) [LSP05G240SH](#) [LSP05G480PNH](#) [LSP05G120SH](#) [LSP05G347PN](#) [LSP05G480SNH](#) [LSP05G240PN](#)
[LSP05G347SN](#) [LSP05G240PH](#) [LSP05G480SH](#) [LSP05G240SN](#) [LSP05G480S](#)