

SP3222 0.9pF 30kV dual channel TVS

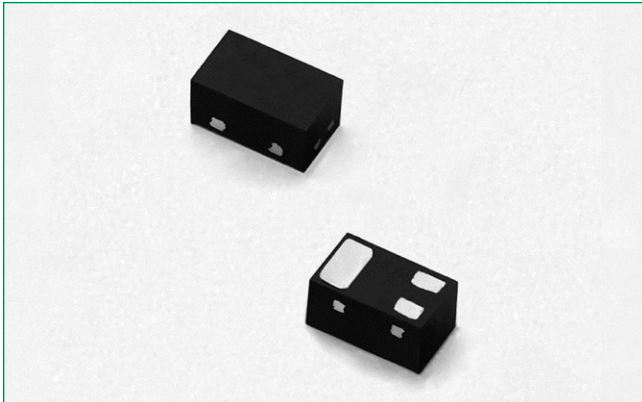

Pinout

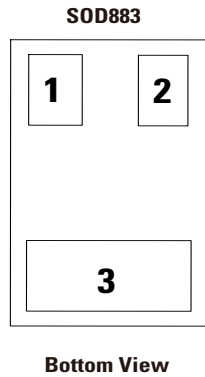

Description

The SP3222 integrates 2 channels of low capacitance diodes to provide protection for electronic equipment that may experience destructive electrostatic discharges (ESD). These robust diodes can safely absorb repetitive ESD strikes above the maximum level specified in the IEC 61000-4-2 international standard ($\pm 30\text{kV}$ contact discharge) without performance degradation. The low loading capacitance makes it ideal for protecting high speed data lines such as DVI, USB2.0, USB3.0 and eSATA.

Features

- ESD protection of $\pm 30\text{kV}$ contact discharge, $\pm 30\text{kV}$ air discharge, (IEC 61000-4-2)
- EFT, IEC 61000-4-4, 40A (5/50ns)
- Lightning protection, IEC 61000-4-5 2nd edition, 3A ($t_p=8/20\mu\text{s}$)
- Low capacitance of 0.9pF @ $V_R=0\text{V}$ (MAX)
- Space efficient 0402 (SOD883) footprint
- Extremely low dynamic resistance (0.17 Ω TYP)
- Moisture Sensitivity Level (MSL -1)
- Halogen free, Lead free and RoHS compliant
- AEC-Q101 qualified

Functional Block Diagram

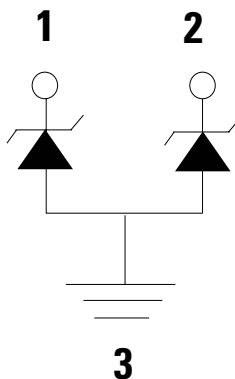

Applications

- USB 3.0/USB 2.0/MHL
- MIPI Camera and Display
- DisplayPort 1.3, eSATA
- Set Top Boxes, Game Consoles
- Smart Phones
- External Storage
- Ultrabooks, Notebooks
- Tablets, eReaders
- High Speed Serial Interfaces

Applications Example

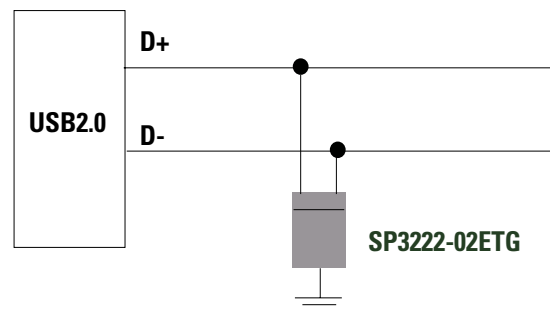

Life Support Note:

Not Intended for Use in Life Support or Life Saving Applications

The products shown herein are not designed for use in life sustaining or life saving applications unless otherwise expressly indicated.

Absolute Maximum Ratings

Symbol	Parameter	Value	Units
P_{PK}	Peak Pulse Power ($t_p=8/20\mu s$)	30	W
I_{PP}	Peak Current ($t_p=8/20\mu s$)	3.0	A
T_{OP}	Operating Temperature	-40 to 125	$^{\circ}C$

CAUTION: Stresses above those listed in "Absolute Maximum Ratings" may cause permanent damage to the component. This is a stress only rating and operation of the component at these or any other conditions above those indicated in the operational sections of this specification is not implied.

Electrical Characteristics ($T_{OP}=25^{\circ}C$)

Parameter	Symbol	Test Conditions	Min	Typ	Max	Units
Reverse Standoff Voltage	V_{RWM}				3.3	V
Forward Bias				-0.9	-0.7	V
Breakdown Voltage	V_{BR}	$I_R=1mA$	6.1	8.0	9.0	V
Reverse Leakage Current	I_{LEAK}	$V_R=3.3V$		0.01	0.1	μA
Clamp Voltage ¹	V_C	$I_{PP}=3A, t_p=8/20\mu s, Fwd$		10		V
Dynamic Resistance ²	R_{DYN}	TLP, $t_p=100ns, I/O$ to GND		0.17		Ω
ESD Withstand Voltage ¹	V_{ESD}	IEC 61000-4-2 (Contact)	± 30			kV
		IEC 61000-4-2 (Air)	± 30			kV
Diode Capacitance ¹	C_D	Reverse Bias=0V			0.9	pF

Note:

- Parameter is guaranteed by design and/or component characterization.
- Transmission Line Pulse (TLP) with 100ns width, 200ps rise time, and average window $t_1=70ns$ to $t_2=90ns$

8/20 μs Pulse Waveform

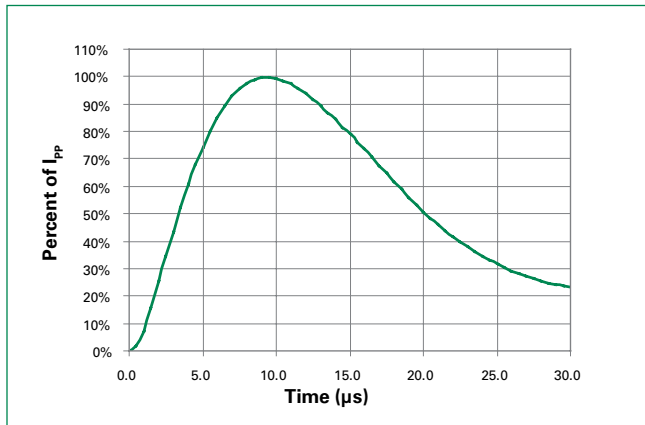

Clamping Voltage vs I_{PP}

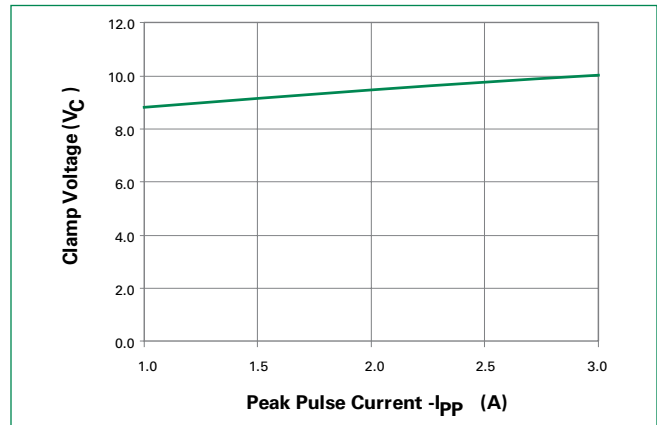

Positive Transmission Line Pulsing (TLP) Plot

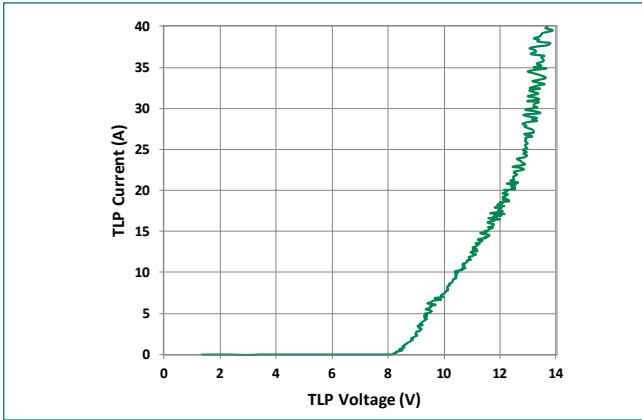

Negative Transmission Line Pulsing (TLP) Plot

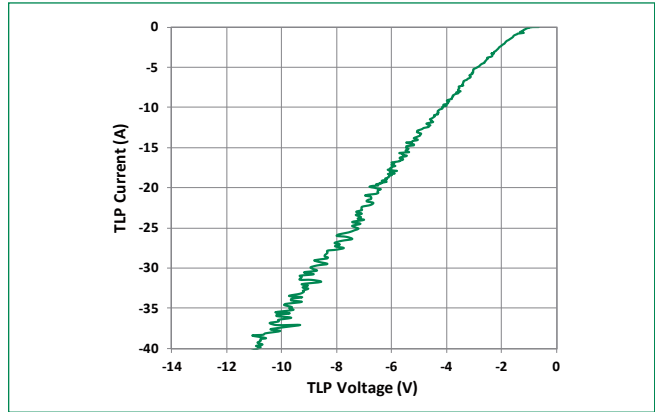

IEC 61000-4-2 +8 kV Contact ESD Clamping Voltage

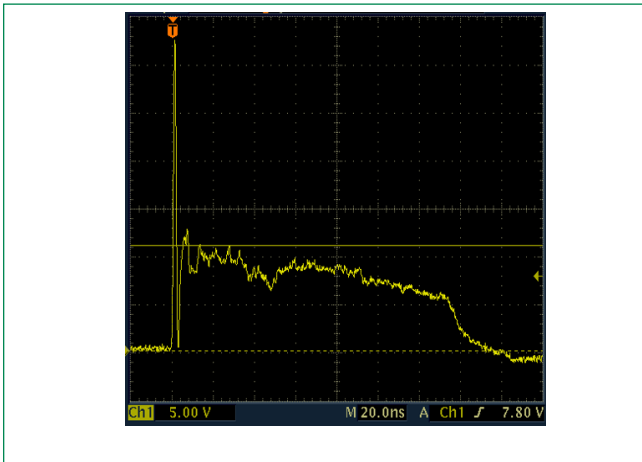

IEC 61000-4-2 -8 kV Contact ESD Clamping Voltage

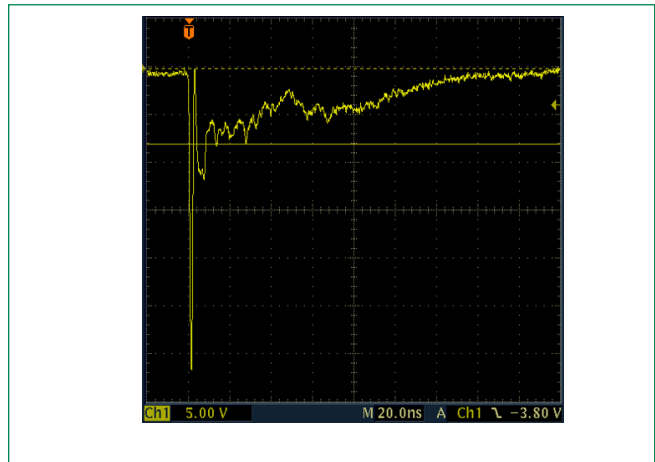

Soldering Parameters

Reflow Condition		Pb - Free assembly
Pre Heat	- Temperature Min ($T_{s(min)}$)	150°C
	- Temperature Max ($T_{s(max)}$)	200°C
	- Time (min to max) (t_p)	60 - 180 secs
Average ramp up rate (Liquidus) Temp (T_L) to peak		3°C/second max
$T_{s(max)}$ to T_L - Ramp-up Rate		3°C/second max
Reflow	- Temperature (T_L) (Liquidus)	217°C
	- Temperature (t_L)	60 - 150 seconds
Peak Temperature (T_p)		260 ^{+0/-5} °C
Time within 5°C of actual peak Temperature (t_p)		20 - 40 seconds
Ramp-down Rate		6°C/second max
Time 25°C to peak Temperature (T_p)		8 minutes Max.
Do not exceed		260°C

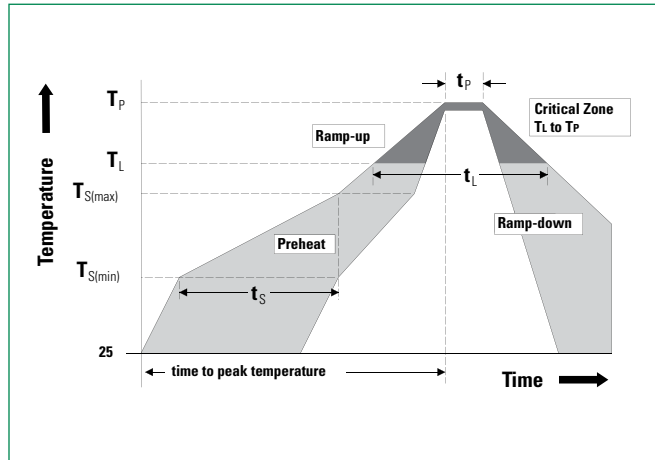

Package Dimensions – SOD883

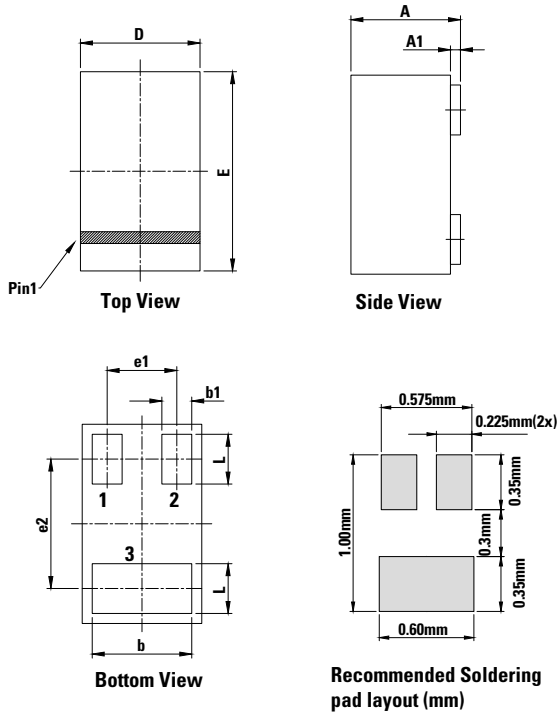

Symbol	Millimeters			Inches		
	Min	Typ	Max	Min	Typ	Max
A	0.45	0.50	0.55	0.018	0.020	0.022
A1	-	0.02	0.05	-	0.001	0.002
D	0.55	0.60	0.65	0.022	0.024	0.026
E	0.95	1.00	1.05	0.037	0.039	0.041
b	0.45	0.55	0.60	0.018	0.022	0.024
b1	0.10	0.15	0.20	0.004	0.006	0.008
L	0.20	0.25	0.30	0.008	0.010	0.012
e1	0.35 BSC			0.014 BSC		
e2	0.65 BSC			0.026 BSC		

Part Marking System

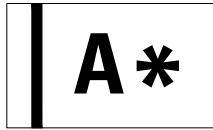

Part Code(A) = SP3222-02ETG
*** = Date code**

Part Numbering System

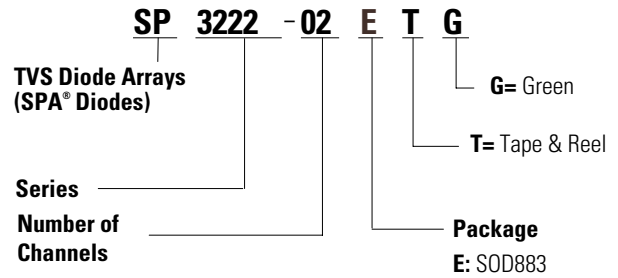

Ordering Information

Part Number	Package	Min. Order Qty.
SP3222-02ETG	SOD883	10000

Embossed Carrier Tape & Reel Specification – SOD883

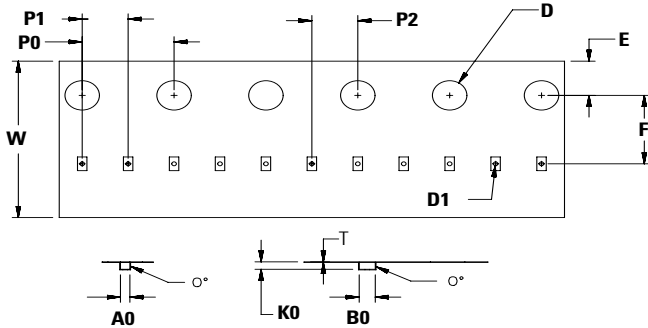

Symbol	Millimeters
A0	0.70+/-0.05
B0	1.15+/-0.05
D	∅ 1.50 + 0.10
D1	∅ 1.55 +/- 0.05
E	1.75+/-0.10
F	3.50+/-0.05
K0	0.47+/-0.05
P0	4.00+/-0.10
P1	2.00+/-0.05
P2	2.00+/-0.05
W	8.00 + 0.30 -0.10
T	0.20+/-0.05

8mm TAPE AND REEL

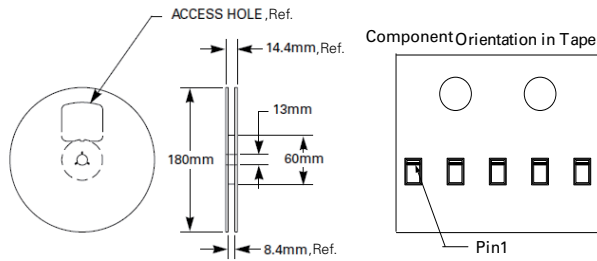

Mouser Electronics

Authorized Distributor

Click to View Pricing, Inventory, Delivery & Lifecycle Information:

[Littelfuse:](#)

[SP3222-02ETG](#)