

1N6267A Series

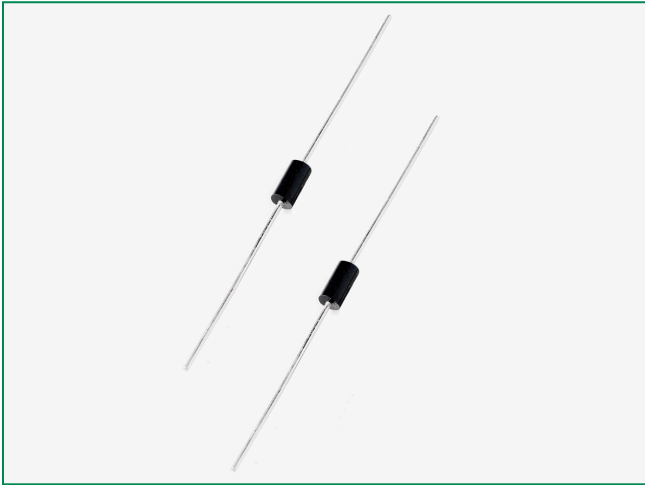

Maximum Ratings and Thermal Characteristics

Rating	Symbol	Value	Unit
Peak Power Dissipation (Note 1) @ $T_L \leq 25^\circ\text{C}$	P_{PK}	1500	W
Steady State Power Dissipation @ $T_L \leq 75^\circ\text{C}$, Lead Length = 3/8" \leq Derated above $T_L = 75^\circ\text{C}$	P_D	5.0 20	W mW/ $^\circ\text{C}$
Thermal Resistance, Junction-to-Lead	$R_{\theta JL}$	20	$^\circ\text{C}/\text{W}$
Forward Surge Current (Note 2) @ $T_A = 25^\circ\text{C}$	I_{FSM}	200	A
Operating and Storage Temperature Range	T_J, T_{stg}	-65 to +175	$^\circ\text{C}/\text{W}$

Maximum ratings are those values beyond which device damage can occur. Maximum ratings applied to the device are individual stress limit values (not normal operating conditions) and are not valid simultaneously. If these limits are exceeded, device functional operation is not implied, damage may occur and reliability may be affected.

1. Nonrepetitive current pulse per Figure 5 and derated above $T_A = 25^\circ\text{C}$ per Figure 2.
2. 1/2 sine wave (or equivalent square wave), $PW = 8.3\text{ ms}$, duty cycle = 4 pulses per minute maximum.

NOTES: Please see 1.5KE6.8CA to 1.5KE250CA for Bidirectional Devices

Description

These devices are designed to protect voltage sensitive components from high voltage, high-energy transients. They have excellent clamping capability, high surge capability, low zener impedance and fast response time. These devices are Littelfuse's exclusive, cost-effective, highly reliable, axial leaded package and are ideally-suited for use in communication systems, numerical controls, process controls, medical equipment, business machines, power supplies and many other industrial/consumer applications, to protect CMOS, MOS and Bipolar integrated circuits.

Features

- Working Peak Reverse Voltage Range – 5.8 V to 214 V
- Peak Power – 1500 Watts @ 1 ms
- ESD Rating of Class 3 (>16 kV) per Human Body Model
- Maximum Clamp Voltage @ Peak Pulse Current
- Low Leakage < 5 μA Above 10 V
- UL 497B for Isolated Loop Circuit Protection
- Response Time is Typically < 1 ns
- Pb-Free Packages are Available

Functional Diagram

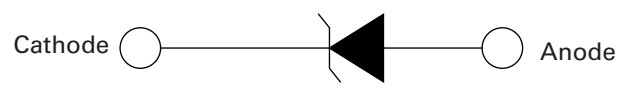

Additional Information



Datasheet



Resources



Samples

I-V Curve Characteristics ($T_A = 25^\circ\text{C}$ unless otherwise noted, $V_F = 3.5\text{ V Max. @ } I_F \text{ (Note 3) } = 100\text{ A}$)

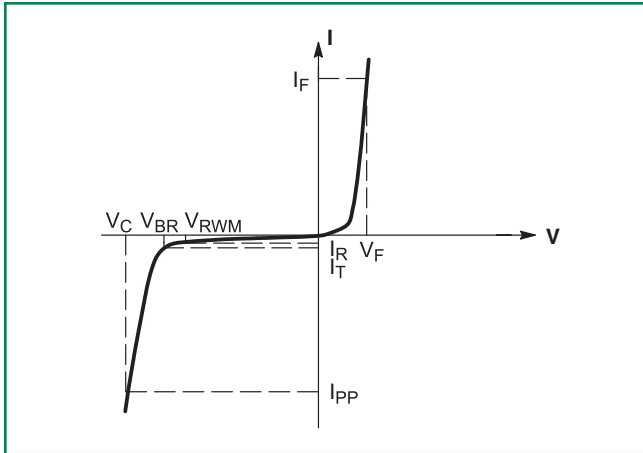

Symbol	Parameter
I_{PP}	Maximum Reverse Peak Pulse Current
V_C	Clamping Voltage @ I_{PP}
V_{RWM}	Working Peak Reverse Voltage
I_R	Maximum Reverse Leakage Current @ V_{RWM}
V_{BR}	Breakdown Voltage @ I_T
I_T	Test Current
I_F	Forward Current
V_F	Forward Voltage @ I_F

Electrical Characteristics ($T_A = 25^\circ\text{C}$ unless otherwise noted, $V_F = 3.5\text{ V Max. @ } I_F \text{ (Note 3) } = 53\text{ A}$)

Device	JEDEC Device† (Note 4)	V_{RWM} (Note 5) (Volts)	$I_R @ V_{RWM}$ (Note 5) (μA)	Breakdown Voltage			$V_C @ I_{PP}$ (Volts) (Note 7)		CV_{BR} ($\text{mV}/^\circ\text{C}$)	
				V_{BR} (V) (Note 6)			$@ I_T$	V_C		I_{PP}
				Min	Nom	Max				
1.5KE6.8A, G	1N6267A, G	5.8	1000	6.45	6.8	7.14	10	10.5	143	0.057
1.5KE7.5A, G	1N6268A, G	6.4	500	7.13	7.5	7.88	10	11.3	132	0.061
1.5KE8.2A, G	1N6269A, G	7.02	200	7.79	8.2	8.61	10	12.1	124	0.065
1.5KE9.1A, G	1N6270A, G	7.78	50	8.65	9.1	9.55	1	13.4	112	0.068
1.5KE10A, G	1N6271A, G	8.55	10	9.5	10	10.5	1	14.5	103	0.073
1.5KE11A, G	1N6272A, G	9.4	5	10.5	11	11.6	1	15.6	96	0.075
1.5KE12A, G	1N6273A, G	10.2	5	11.4	12	12.6	1	16.7	90	0.078
1.5KE13A, G	1N6274A, G	11.1	5	12.4	13	13.7	1	18.2	82	0.081
1.5KE15A, G	1N6275A, G	12.8	5	14.3	15	15.8	1	21.2	71	0.084
1.5KE16A, G	1N6276A, G	13.6	5	15.2	16	16.8	1	22.5	67	0.086
1.5KE18A, G	1N6277A, G	15.3	5	17.1	18	18.9	1	25.2	59.5	0.088
1.5KE20A, G	1N6278A, G	17.1	5	19	20	21	1	27.7	54	0.09
1.5KE22A, G	1N6279A, G	18.8	5	20.9	22	23.1	1	30.6	49	0.092
1.5KE24A, G	1N6280A, G	20.5	5	22.8	24	25.2	1	33.2	45	0.094
1.5KE27A, G	1N6281A, G	23.1	5	25.7	27	28.4	1	37.5	40	0.096
1.5KE30A, G	1N6282A, G	25.6	5	28.5	30	31.5	1	41.4	36	0.097
1.5KE33A, G	1N6283A, G	28.2	5	31.4	33	34.7	1	45.7	33	0.098

Electrical Characteristics (TA = 25 ° C unless otherwise noted, VF = 3.5 V Max. @ IF (Note 3) = 53 A)

Device	JEDEC Device† (Note 4)	V _{RWM} (Note 5) (Volts)	I _R @ V _{RWM} (µA)	Breakdown Voltage				V _C @ I _{PP} (Volts) (Note 7)		CV _{BR} (mV/°C)
				V _{BR} (V) (Note 6)			@ I _T	V _C	I _{PP}	
				Min	Nom	Max	(mA)	(Volts)	(A)	
1.5KE36A, G	1N6284A, G	30.8	5	34.2	36	37.8	1	49.9	30	0.099
1.5KE39A, G	1N6285A, G	33.3	5	37.1	39	41	1	53.9	28	0.1
1.5KE43A, G	1N6286A, G	36.8	5	40.9	43	45.2	1	59.3	25.3	0.101
1.5KE47A, G	1N6287A, G	40.2	5	44.7	47	49.4	1	64.8	23.2	0.101
1.5KE51A, G	1N6288A, G	43.6	5	48.5	51	53.6	1	70.1	21.4	0.102
1.5KE56A, G	1N6289A, G	47.8	5	53.2	56	58.8	1	77	19.5	0.103
1.5KE62A, G	1N6290A, G	53	5	58.9	62	65.1	1	85	17.7	0.104
1.5KE68A, G	1N6291A, G	58.1	5	64.6	68	71.4	1	92	16.3	0.104
1.5KE75A, G	1N6292A, G	64.1	5	71.3	75	78.8	1	103	14.6	0.105
1.5KE82A, G	1N6293A, G	70.1	5	77.9	82	86.1	1	113	13.3	0.105
1.5KE91A, G	1N6294A, G	77.8	5	86.5	91	95.5	1	125	12	
1.5KE100A, G	1N6295A, G	85.5	5	95	100	105	1	137	11	0.106
1.5KE110A, G	1N6296A, G	94	5	105	110	116	1	152	9.9	0.107
1.5KE120A, G	1N6297A, G	102	5	114	120	126	1	165	9.1	0.107
1.5KE130A, G	1N6298A, G	111	5	124	130	137	1	179	8.4	0.107
1.5KE150A, G	1N6299A, G	128	5	143	150	158	1	207	7.2	0.108
1.5KE160A, G	1N6300A, G	136	5	152	160	168	1	219	6.8	0.108
1.5KE170A, G	1N6301A, G	145	5	162	170	179	1	234	6.4	0.108
1.5KE180A, G	1N6302A, G*	154	5	171	180	189	1	246	6.1	0.108
1.5KE200A, G	1N6303A, G	171	5	190	200	210	1	274	5.5	0.108
1.5KE220A, G	—	185	5	209	220	231	1	328	4.6	0.109
1.5KE250A, G	—	214	5	237	250	263	1	344	5	0.109

Devices listed in **bold italic** are Littelfuse Preferred devices. **Preferred devices** are recommended choices for future use and best overall value.

3. 1/2 sine wave (or equivalent square wave), PW = 8.3 ms, duty cycle = 4 pulses per minute maximum.

4. Indicates JEDEC registered data

5. A transient suppressor is normally selected according to the maximum working peak reverse voltage (VRWM), which should be equal to or greater than the dc or continuous peak operating voltage level.

6. VBR measured at pulse test current IT at an ambient temperature of 25 °C

7. Surge current waveform per Figure 5 and derate per Figures 1 and 2.

†The "G" suffix indicates Pb-Free package available.

*Not Available in the 1500/Tape & Reel

Ratings and Characteristic Curves

Figure 1. Pulse Rating Curve

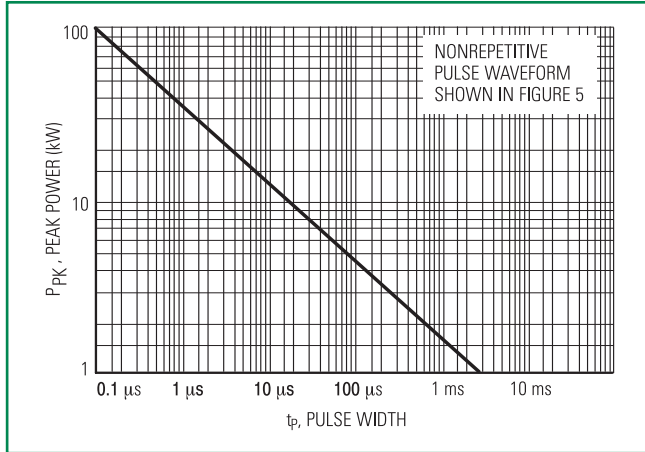

Figure 2. Pulse Derating Curve

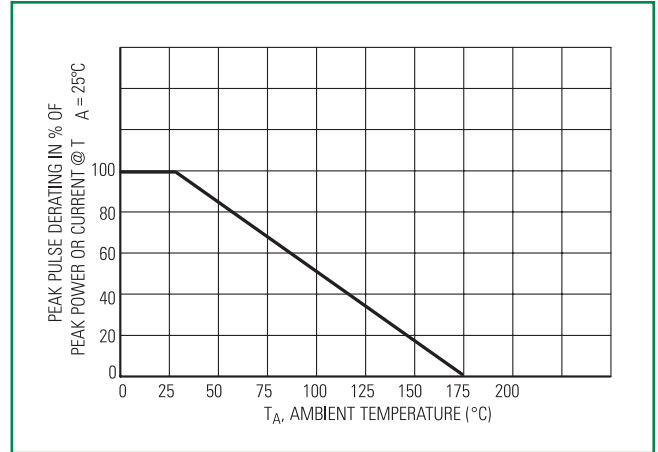
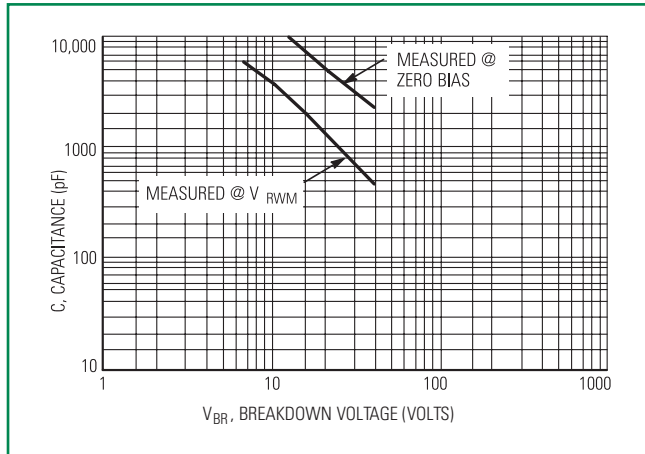

Figure 3. Capacitance versus Breakdown Voltage

1N6373, ICTE-5, MPTE-5, through 1N6389, ICTE-45, C, MPTE-45, C



1N6267A/1.5KE6.8A through 1N6303A/1.5KE200A

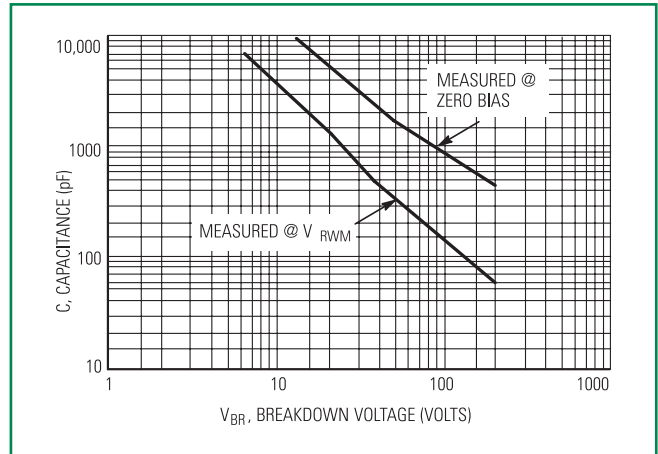

Figure 4. Steady State Power Derating

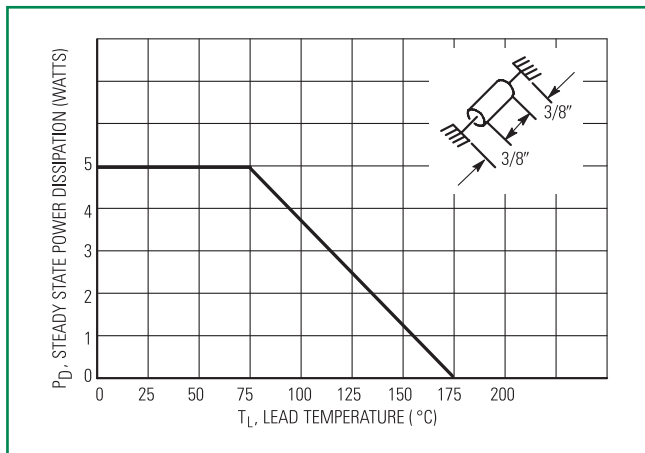
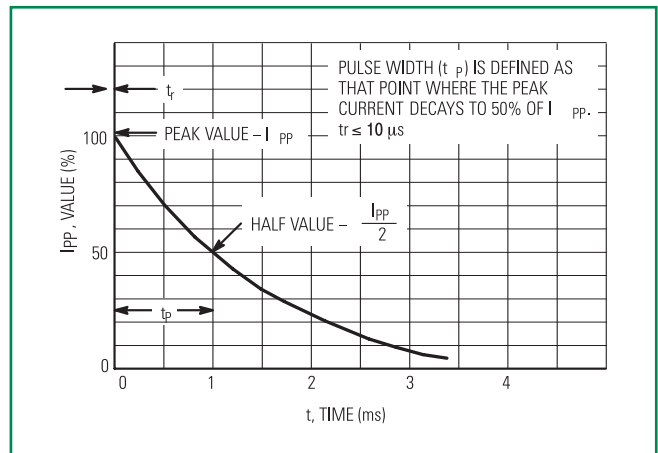

Figure 5. Pulse Waveform



Ratings and Characteristic Curves

Figure 6. Dynamic Impedance

1N6373, ICTE-5, MPTE-5, through 1N6389, ICTE-45, C, MPTE-45, C

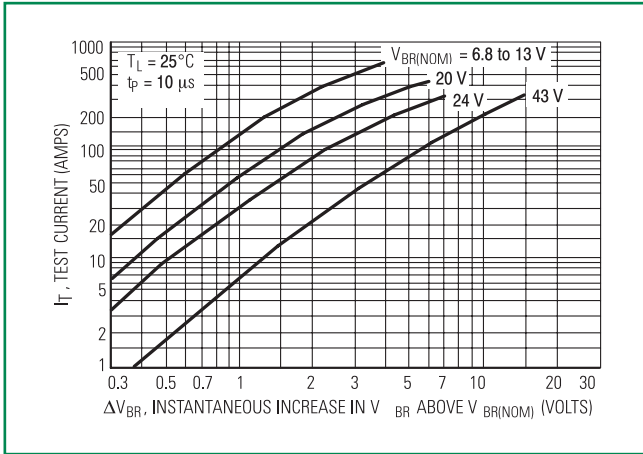

1.5KE6.8A through 1.5KE200A

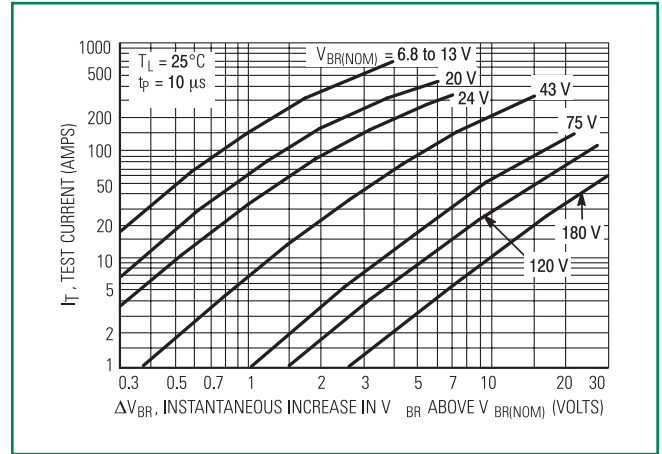
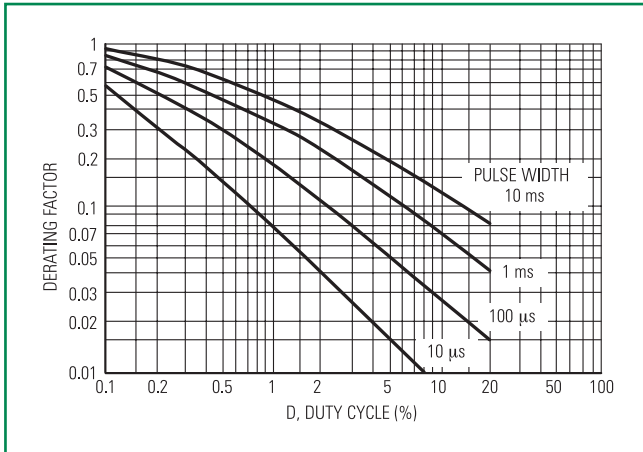

Figure 7. Typical Derating Factor for Duty Cycle



Application Notes

Response Time

In most applications, the transient suppressor device is placed in parallel with the equipment or component to be protected. In this situation, there is a time delay associated with the capacitance of the device and an overshoot condition associated with the inductance of the device and the inductance of the connection method. The capacitance effect is of minor importance in the parallel protection scheme because it only produces a time delay in the transition from the operating voltage to the clamp voltage as shown in Figure 8.

The inductive effects in the device are due to actual turn-on time (time required for the device to go from zero current to full current) and lead inductance. This inductive effect produces an overshoot in the voltage across the equipment or component being protected as shown in Figure 9. Minimizing this overshoot is very important in the application, since the main purpose for adding a transient suppressor is to clamp voltage spikes. These devices have excellent response time, typically in the picosecond range and negligible inductance. However, external inductive effects could produce unacceptable overshoot. Proper circuit layout,

minimum lead lengths and placing the suppressor device as close as possible to the equipment or components to be protected will minimize this overshoot. Some input impedance represented by Z_{in} is essential to prevent overstress of the protection device. This impedance should be as high as possible, without restricting the circuit operation.

Duty Cycle Derating

The data of Figure 1 applies for non-repetitive conditions and at a lead temperature of 25°C. If the duty cycle increases, the peak power must be reduced as indicated by the curves of Figure 7. Average power must be derated as the lead or ambient temperature rises above 25°C. The average power derating curve normally given on data sheets may be normalized and used for this purpose.

At first glance the derating curves of Figure 7 appear to be in error as the 10 ms pulse has a higher derating factor than the 10 μ s pulse. However, when the derating factor for a given pulse of Figure 7 is multiplied by the peak power value of Figure 1 for the same pulse, the results follow the expected trend.

Typical Protection Circuit

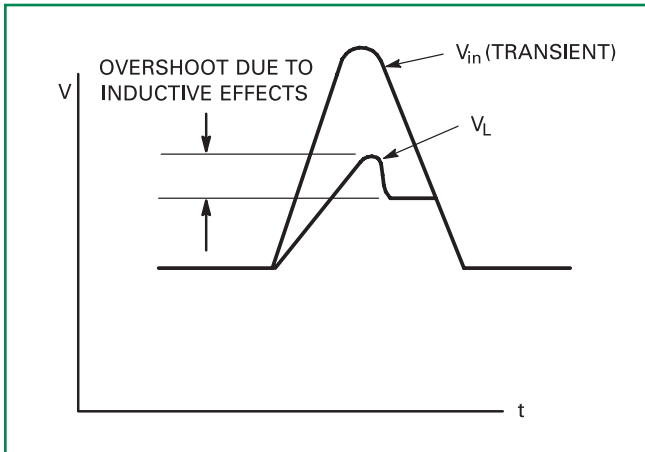
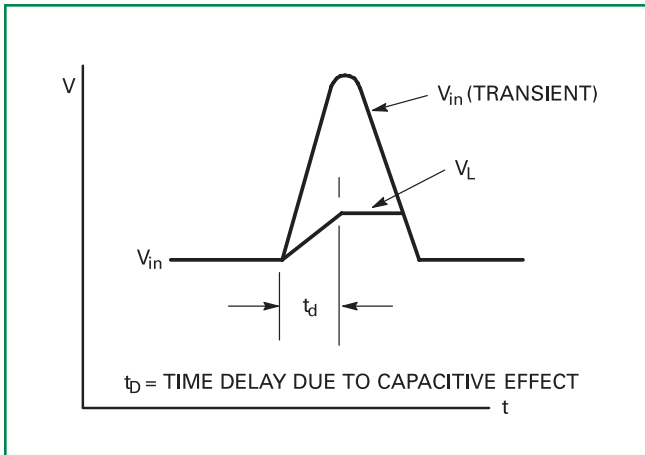
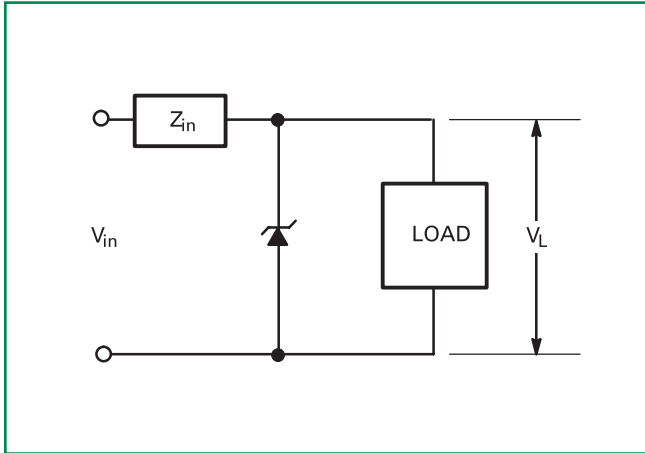

UL Recognition*

The entire series has Underwriters Laboratory Recognition for the classification of protectors (QVGV2) under the UL standard for safety 497B and File #116110. Many competitors only have one or two devices recognized or have recognition in a non-protective category. Some competitors have no recognition at all. With the UL497B recognition, our parts successfully passed several tests including Strike Voltage Breakdown test, Endurance

Conditioning, Temperature test, Dielectric Voltage-Withstand test, Discharge test and several more. Whereas, some competitors have only passed a flammability test for the package material, we have been recognized for much more to be included in their Protector category.

*Applies to 1.5KE6.8A, CA thru 1.5KE250A, CA

Clipper Bi-Directional Devices

1. Clipper-bidirectional devices are available in the 1.5KEXXA series and are designated with a "CA" suffix; for example, 1.5KE18CA. Contact your nearest Littelfuse representative.
2. Clipper-bidirectional part numbers are tested in both directions to electrical parameters in preceding table (except for VF which does not apply)
3. The 1N6267A through 1N6303A series are JEDEC registered devices and the registration does not include a "CA" suffix. To order clipper-bidirectional devices one must add CA to the 1.5KE device title.

Dimensions

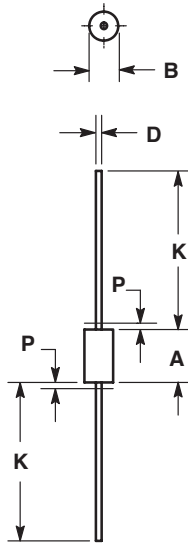

Dim	Inches		Millimeters	
	Min	Max	Min	Max
A	0.335	0.374	8.50	9.50
B	0.189	0.209	4.80	5.30
D	0.038	0.042	0.96	1.06
K	1.000	—	25.40	—
P	—	0.050	—	1.27

NOTES:

1. DIMENSIONING AND TOLERANCING PER ANSI Y14.5M, 1982.
2. CONTROLLING DIMENSION: INCH.
3. LEAD FINISH AND DIAMETER UNCONTROLLED IN DIMENSION P.
4. 041A-01 THRU 041A-03 OBSOLETE, NEW STANDARD 041A-04.

Part Marking System

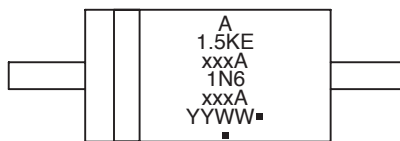

- A= Assembly Location
- 1.5KExxxA= ON Device Code
- 1N6xxxA= JEDEC Device Code
- YY = Year
- WW = Work Week
(See Table on Page 3)
- = Pb-Free Package
(Note: Microdot may be in either location)

ORDERING INFORMATION

Device	Package	Shipping†
1.5KExxxA	Axial Lead	500 Units/Box
1.5KExxxAG	Axial Lead (Pb-Free)	500 Units/Box
1.5KExxxARL4	Axial Lead	1500/Tape & Reel
1.5KExxxARL4G	Axial Lead (Pb-Free)	1500/Tape & Reel
1N6xxxA	Axial Lead	500 Units/Box
1N6xxxAG	Axial Lead (Pb-Free)	500 Units/Box
1N6xxxARL4	Axial Lead	1500/Tape & Reel
1N6xxxARL4G	Axial Lead (Pb-Free)	1500/Tape & Reel

Flow/Wave Soldering (Solder Dipping)

Peak Temperature :	260°C
Dipping Time :	1/16" from the case for 10 seconds

Physical Specifications

Case	Void-free, transfer-molded, thermosetting plastic
Leads	Modified L-Bend providing more contact area to bond pads
Finish	All external surfaces are corrosion resistant and leads are readily solderable
Mounting Position	Any

Disclaimer Notice - Information furnished is believed to be accurate and reliable. However, users should independently evaluate the suitability of and test each product selected for their own applications. Littelfuse products are not designed for, and may not be used in, all applications. Read complete Disclaimer Notice at: www.littelfuse.com/disclaimer-electronics.

Mouser Electronics

Authorized Distributor

Click to View Pricing, Inventory, Delivery & Lifecycle Information:

Littelfuse:

[1N6290AG](#) [1N6289ARL4G](#) [1.5KE43AG](#) [1.5KE56ARL4G](#) [1N6285ARL4G](#) [1.5KE39ARL4G](#) [1N6285AG](#)
[1.5KE24ARL4G](#) [1.5KE27ARL4G](#) [1.5KE11ARL4G](#) [1N6280ARL4G](#) [1.5KE13ARL4G](#) [1.5KE43ARL4G](#) [1N6290ARL4G](#)
[1N6279AG](#) [1N6286AG](#) [1N6281AG](#) [1.5KE27AG](#) [1N6274AG](#) [1.5KE62AG](#) [1.5KE62ARL4G](#)