

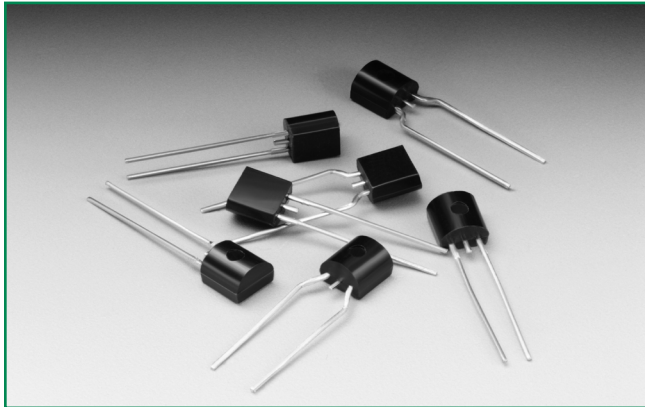

SIDACtor® Series - TO-92



Agency Approvals

| Agency | Agency File Number |
|---|--------------------|
|  | E133083 |

Pinout Designation

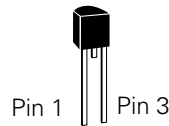

Schematic Symbol



Description

SIDACtor® Series TO-92 are designed to protect baseband equipment such as modems, line cards, CPE and DSL from damaging overvoltage transients.

The series provides a robust through-hole solution that enables equipment to comply with global regulatory standards.

Features and Benefits

- Low voltage overshoot
- Low on-state voltage
- Does not degrade surge capability after multiple surge events within limit.
- Fails short circuit when surged in excess of ratings
- Low capacitance
- 2nd level interconnect is Pb-free per IPC/ JEDEC J-STD-609A.01

Applicable Global Standards

- TIA-968-A
- TIA-968-B
- ITU K.20/21 Enhanced Level*
- ITU K.20/21 Basic Level
- GR 1089 Inter-building*
- GR 1089 Intra-building
- IEC 61000-4-5
- YD/T 1082
- YD/T 993
- YD/T 950

* A/B-rated parts require series resistance

Electrical Characteristics

| Part Number | Marking | V_{DRM} | V_S | I_H | I_S | I_T | V_T | Capacitance | |
|-------------|---------|--------------------|-----------------|--------|--------|-------|------------------|-----------------|--------|
| | | @ $I_{DRM}=5\mu A$ | @ 100V/ μs | mA min | mA max | A max | @ $I_T=2.2$ Amps | @ 1MHz, 2V bias | |
| | | V min | V max | | | | V max | pF min | pF max |
| P0080EALxxx | P0080EA | 6 | 25 | 50 | 800 | 2.2 | 4 | 25 | 150 |
| P0300EALxxx | P0300EA | 25 | 40 | 50 | 800 | 2.2 | 4 | 15 | 140 |
| P0640EALxxx | P0640EA | 58 | 77 | 150 | 800 | 2.2 | 4 | 40 | 60 |
| P0720EALxxx | P0720EA | 65 | 88 | 150 | 800 | 2.2 | 4 | 35 | 60 |
| P0900EALxxx | P0900EA | 75 | 98 | 150 | 800 | 2.2 | 4 | 35 | 55 |
| P1100EALxxx | P1100EA | 90 | 130 | 150 | 800 | 2.2 | 4 | 30 | 50 |
| P1300EALxxx | P1300EA | 120 | 160 | 150 | 800 | 2.2 | 4 | 25 | 45 |
| P1500EALxxx | P1500EA | 140 | 180 | 150 | 800 | 2.2 | 4 | 25 | 40 |
| P1800EALxxx | P1800EA | 170 | 220 | 150 | 800 | 2.2 | 4 | 25 | 35 |
| P2300EALxxx | P2300EA | 190 | 260 | 150 | 800 | 2.2 | 4 | 25 | 35 |
| P2600EALxxx | P2600EA | 220 | 300 | 150 | 800 | 2.2 | 4 | 20 | 35 |
| P3100EALxxx | P3100EA | 275 | 350 | 150 | 800 | 2.2 | 4 | 20 | 35 |
| P3500EALxxx | P3500EA | 320 | 400 | 150 | 800 | 2.2 | 4 | 20 | 35 |

Table continues on next page.

Electrical Characteristics (continued)

| Part Number | Marking | V_{DRM} @ $I_{DRM}=5\mu A$ | V_S @ 100V/ μs | I_H | I_S | I_T | V_T @ $I_T=2.2$ Amps | Capacitance @ 1MHz, 2V bias | |
|-------------|---------|---------------------------------|--------------------------|--------|--------|-------|---------------------------|--------------------------------|--------|
| | | V Min | V Max | mA Min | mA Max | A Max | V Max | pF Min | pF Max |
| P0080EBLxxx | P0080EB | 6 | 25 | 50 | 800 | 2.2 | 4 | 25 | 150 |
| P0300EBLxxx | P0300EB | 25 | 40 | 50 | 800 | 2.2 | 4 | 15 | 140 |
| P0640EBLxxx | P0640EB | 58 | 77 | 150 | 800 | 2.2 | 4 | 40 | 60 |
| P0720EBLxxx | P0720EB | 65 | 88 | 150 | 800 | 2.2 | 4 | 35 | 75 |
| P0900EBLxxx | P0900EB | 75 | 98 | 150 | 800 | 2.2 | 4 | 35 | 70 |
| P1100EBLxxx | P1100EB | 90 | 130 | 150 | 800 | 2.2 | 4 | 30 | 70 |
| P1300EBLxxx | P1300EB | 120 | 160 | 150 | 800 | 2.2 | 4 | 25 | 60 |
| P1500EBLxxx | P1500EB | 140 | 180 | 150 | 800 | 2.2 | 4 | 25 | 55 |
| P1800EBLxxx | P1800EB | 170 | 220 | 150 | 800 | 2.2 | 4 | 25 | 50 |
| xxx | P2300EB | 190 | 260 | 150 | 800 | 2.2 | 4 | 25 | 50 |
| P2600EBLxxx | P2600EB | 220 | 300 | 150 | 800 | 2.2 | 4 | 20 | 45 |
| P3100EBLxxx | P3100EB | 275 | 350 | 150 | 800 | 2.2 | 4 | 20 | 45 |
| P3500EBLxxx | P3500EB | 320 | 400 | 150 | 800 | 2.2 | 4 | 20 | 40 |
| P0080ECLxxx | P0080EC | 6 | 25 | 50 | 800 | 2.2 | 4 | 35 | 260 |
| P0300ECLxxx | P0300EC | 25 | 40 | 50 | 800 | 2.2 | 4 | 25 | 250 |
| P0640ECLxxx | P0640EC | 58 | 77 | 150 | 800 | 2.2 | 4 | 55 | 155 |
| P0720ECLxxx | P0720EC | 65 | 88 | 150 | 800 | 2.2 | 4 | 50 | 150 |
| P0900ECLxxx | P0900EC | 75 | 98 | 150 | 800 | 2.2 | 4 | 45 | 140 |
| P1100ECLxxx | P1100EC | 90 | 130 | 150 | 800 | 2.2 | 4 | 45 | 115 |
| P1300ECLxxx | P1300EC | 120 | 160 | 150 | 800 | 2.2 | 4 | 40 | 105 |
| P1500ECLxxx | P1500EC | 140 | 180 | 150 | 800 | 2.2 | 4 | 35 | 95 |
| P1800ECLxxx | P1800EC | 170 | 220 | 150 | 800 | 2.2 | 4 | 35 | 90 |
| P2300ECLxxx | P2300EC | 190 | 260 | 150 | 800 | 2.2 | 4 | 30 | 80 |
| P2600ECLxxx | P2600EC | 220 | 300 | 150 | 800 | 2.2 | 4 | 30 | 80 |
| P3100ECLxxx | P3100EC | 275 | 350 | 150 | 800 | 2.2 | 4 | 30 | 70 |
| P3500ECLxxx | P3500EC | 320 | 400 | 150 | 800 | 2.2 | 4 | 25 | 65 |

Notes:
 - Absolute maximum ratings measured at $T_J = 25^\circ C$ (unless otherwise noted).
 - Devices are bi-directional (unless otherwise noted).

Notes:
 - xxx part number suffix: 'AP' = Ammo Pack, 'RP1' and 'RP2' = Reel Pack, blank = Bulk Pack

Surge Ratings

| Series | I_{PP} | | | | | | | | | I_{TSM} 50/60 Hz | di/dt |
|--------|----------------------|-------------------|---------------------|---------------------|---------------------|--------------------|---------------------|----------------------|---------------------|-----------------------|----------------|
| | 0.2x310 ¹ | 2x10 ¹ | 8x20 ¹ | 10x160 ¹ | 10x560 ¹ | 5x320 ¹ | 10x360 ¹ | 10x1000 ¹ | 5x310 ¹ | | |
| | 0.5x700 ² | 2x10 ² | 1.2x50 ² | 10x160 ² | 10x560 ² | 9x720 ² | 10x360 ² | 10x1000 ² | 10x700 ² | | |
| | A min | A min | A min | A min | A min | A min | A min | A min | A min | A min | A/ μs max |
| A | 20 | 150 | 150 | 90 | 50 | 75 | 75 | 45 | 75 | 20 | 500 |
| B | 25 | 250 | 250 | 150 | 100 | 100 | 125 | 80 | 100 | 25 | 500 |
| C | 50 | 500 | 400 | 200 | 150 | 200 | 175 | 100 | 200 | 30 | 500 |

Notes:
 1 Current waveform in μs
 2 Voltage waveform in μs
 - Peak pulse current rating (I_{PP}) is repetitive and guaranteed for the life of the product that remains in thermal equilibrium.
 - I_{PP} ratings applicable over temperature range of $-40^\circ C$ to $+85^\circ C$
 - The device must initially be in thermal equilibrium with $-40^\circ C \leq T_J \leq +150^\circ C$

Thermal Considerations

| Package | Symbol | Parameter | Value | Unit |
|---|-----------------|---|-------------|--------------|
| TO-92  | T_J | Operating Junction Temperature Range | -40 to +150 | $^\circ C$ |
| | T_S | Storage Temperature Range | -65 to +150 | $^\circ C$ |
| | $R_{\theta JA}$ | Thermal Resistance: Junction to Ambient | 90 | $^\circ C/W$ |

V-I Characteristics

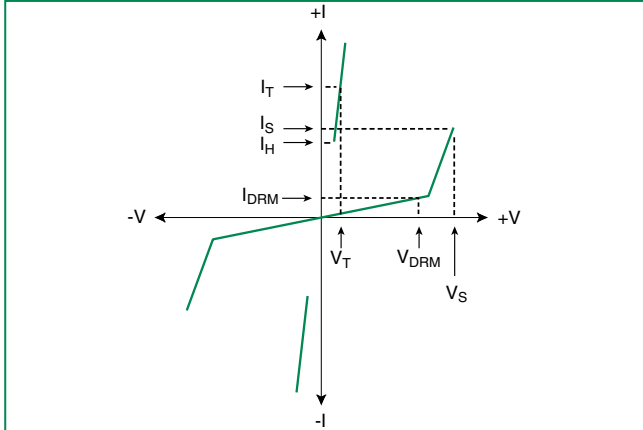

$t_r \times t_d$ Pulse Waveform

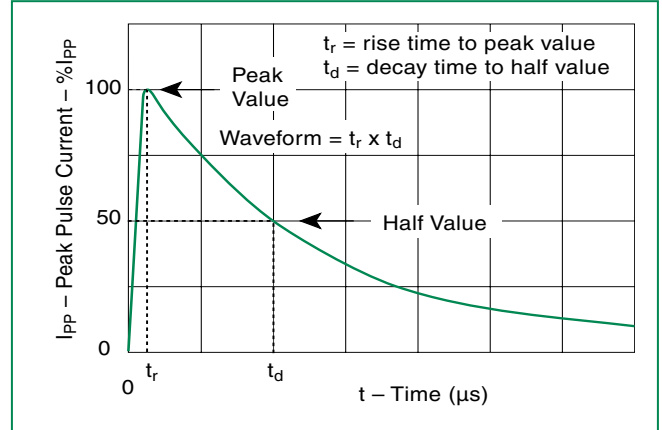

Normalized V_S Change vs. Junction Temperature

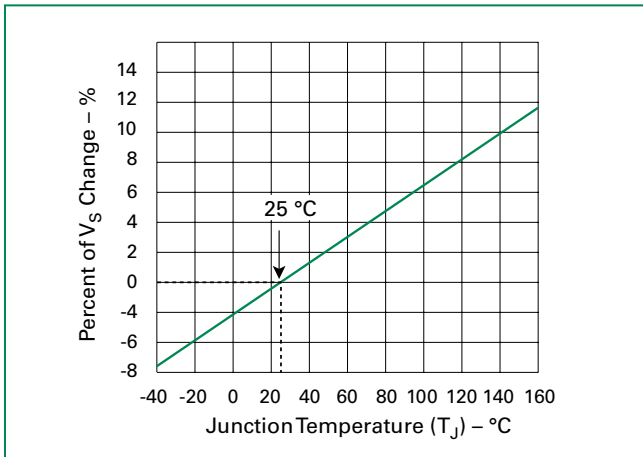

Normalized DC Holding Current vs. Case Temperature

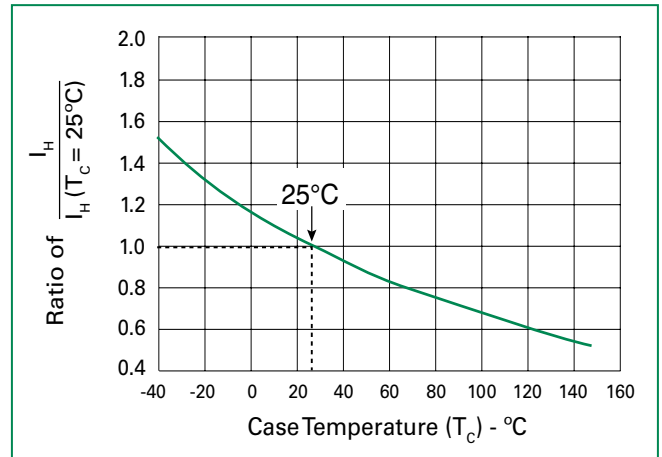

Soldering Parameters

| | | |
|---|-----------------------------------|-------------------------------|
| Reflow Condition | | Pb-Free assembly (see Fig. 1) |
| Pre Heat | -Temperature Min ($T_{s(min)}$) | +150 $^{\circ}C$ |
| | -Temperature Max ($T_{s(max)}$) | +200 $^{\circ}C$ |
| | -Time (Min to Max) (t_s) | 60-180 secs. |
| Average ramp up rate (Liquidus Temp (T_L) to peak) | | 3 $^{\circ}C$ /sec. Max. |
| $T_{s(max)}$ to T_L - Ramp-up Rate | | 3 $^{\circ}C$ /sec. Max. |
| Reflow | -Temperature (T_L) (Liquidus) | +217 $^{\circ}C$ |
| | -Temperature (t_L) | 60-150 secs. |
| Peak Temp (T_p) | | +260(+0/-5) $^{\circ}C$ |
| Time within 5 $^{\circ}C$ of actual Peak Temp (t_p) | | 30 secs. Max. |
| Ramp-down Rate | | 6 $^{\circ}C$ /sec. Max. |
| Time 25 $^{\circ}C$ to Peak Temp (T_p) | | 8 min. Max. |
| Do not exceed | | +260 $^{\circ}C$ |

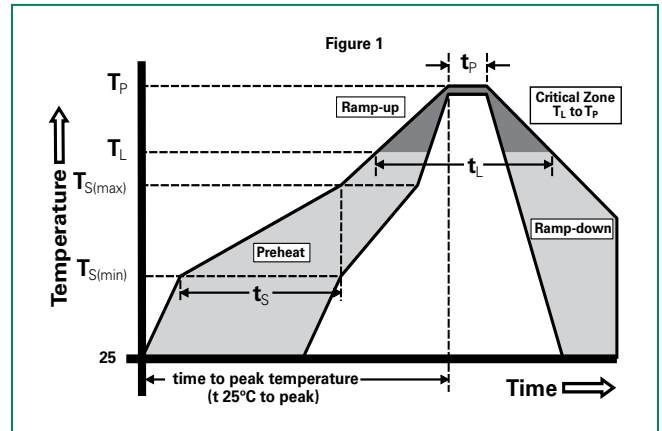

Physical Specifications

| | |
|------------------------|---|
| Lead Material | Copper Alloy |
| Terminal Finish | 100% Matte-Tin Plated |
| Body Material | UL recognized epoxy meeting flammability classification 94V-0 |

Environmental Specifications

| | |
|---|---|
| High Temp Voltage Blocking | 80% Rated V_{DRM} (V_{AC} Peak) +125°C or +150°C, 504 or 1008 hrs. MIL-STD-750 (Method 1040) JEDEC, JESD22-A-101 |
| Temp Cycling | -65°C to +150°C, 15 min. dwell, 10 up to 100 cycles. MIL-STD-750 (Method 1051) EIA/JEDEC, JESD22-A104 |
| Biased Temp & Humidity | 52 V_{DC} (+85°C) 85%RH, 504 up to 1008 hrs. EIA/JEDEC, JESD22-A-101 |
| High Temp Storage | +150°C 1008 hrs. MIL-STD-750 (Method 1031) JEDEC, JESD22-A-101 |
| Low Temp Storage | -65°C, 1008 hrs. |
| Thermal Shock | 0°C to +100°C, 5 min. dwell, 10 sec. transfer, 10 cycles. MIL-STD-750 (Method 1056) JEDEC, JESD22-A-106 |
| Autoclave (Pressure Cooker Test) | +121°C, 100%RH, 2atm, 24 up to 168 hrs. EIA/JEDEC, JESD22-A-102 |
| Resistance to Solder Heat | +260°C, 30 secs. MIL-STD-750 (Method 2031) |
| Moisture Sensitivity Level | 85%RH, +85°C, 168 hrs., 3 reflow cycles (+260°C Peak). JEDEC-J-STD-020, Level 1 |

Part Numbering

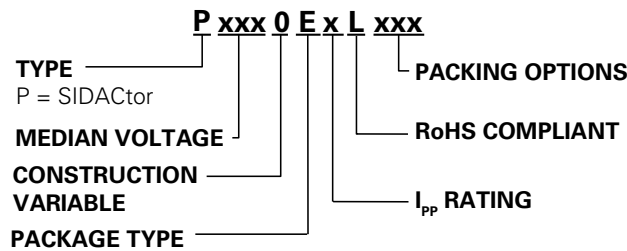

Part Marking

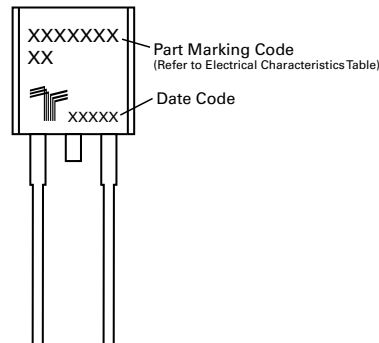

Packing Options

| Package Type | Description | Packing Options Quantity | Added Suffix | Lead Spacing | Industry Standard |
|--------------|--------------------------|--------------------------|--------------|-------------------|-------------------|
| E | TO-92 Tape and Reel Pack | 2000 | RP1 | 0.1 inch (2.54mm) | EIA-481-D |
| | TO-92 Ammo Pack | | RP2 | 0.2 inch (5.08mm) | |
| | TO-92 Bulk Pack | | AP | | EIA-468-B |
| | | | N/A | | N/A |

Additional Information



Datasheet



Resources



Samples

Dimensions — TO-92

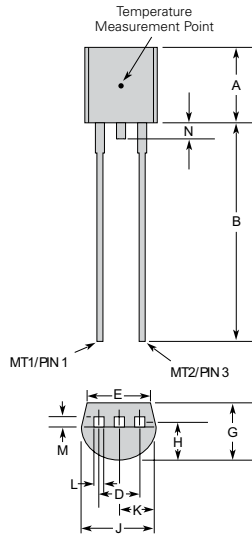

| | Inches | | Millimeters | |
|---|--------|-------|-------------|------|
| | Min | Max | Min | Max |
| A | 0.176 | 0.196 | 4.47 | 4.98 |
| B | 0.500 | | 12.70 | |
| D | 0.095 | 0.105 | 2.41 | 2.67 |
| E | 0.150 | | 3.81 | |
| G | 0.135 | 0.145 | 3.43 | 3.68 |
| H | 0.088 | 0.096 | 2.23 | 2.44 |
| J | 0.176 | 0.186 | 4.47 | 4.73 |
| K | 0.088 | 0.096 | 2.23 | 2.44 |
| L | 0.013 | 0.019 | 0.33 | 0.48 |
| M | 0.013 | 0.017 | 0.33 | 0.43 |
| N | | 0.60 | | 1.52 |

All leads are insulated from case. Case is electrically non-conductive. (Rated at 1600 V_{(AC) RMS} for one minute from leads to case over the operating temperature range.)

Mold flash shall not exceed 0.13 mm per side.

The TO-92 is designed to meet mechanical standards as set forth in JEDEC publication number 95.

Ammo Pack Specification — TO-92

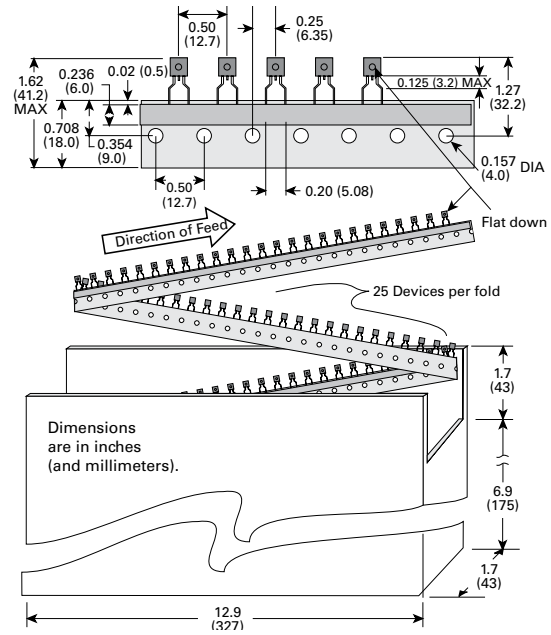

Tape and Reel Specification — TO-92

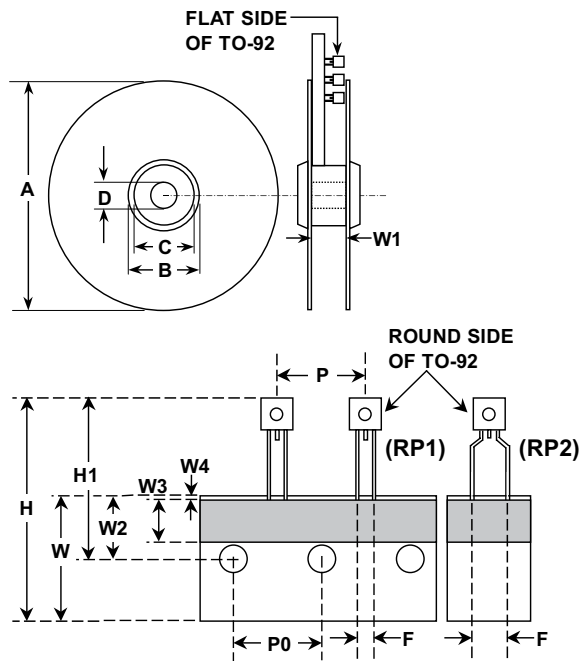

| Dimensions | Inches | | Millimeters | |
|------------|--------|--------|-------------|-------|
| | Min | Max | Min | Max |
| A | N/A | 14.173 | N/A | 360.0 |
| B | 4.016 | N/A | 102.0 | N/A |
| C | 3.386 | N/A | 86.0 | N/A |
| D | 0.795 | N/A | 20.2 | N/A |
| W1 | 1.181 | 1.968 | 30.0 | 50.0 |
| P | 0.496 | 0.504 | 12.60 | 12.80 |
| P0 | 0.498 | 0.502 | 12.65 | 12.75 |
| F(for RP1) | 0.090 | 0.110 | 2.29 | 2.80 |
| F(for RP2) | 0.182 | 0.244 | 4.63 | 6.19 |
| H | N/A | 1.673 | N/A | 42.50 |
| H1 | N/A | 1.270 | N/A | 32.26 |
| W | 0.674 | 0.763 | 17.12 | 19.38 |
| W2 | 0.354 | 0.370 | 8.25 | 9.75 |
| W3 | 0.236 | N/A | 6.00 | N/A |
| W4 | 0.020 | N/A | 0.50 | N/A |

Disclaimer Notice - Information furnished is believed to be accurate and reliable. However, users should independently evaluate the suitability of and test each product selected for their own applications. Littelfuse products are not designed for, and may not be used in, all applications. Read complete Disclaimer Notice at www.littelfuse.com/disclaimer-electronics.

Mouser Electronics

Authorized Distributor

Click to View Pricing, Inventory, Delivery & Lifecycle Information:

Littelfuse:

[P0720SB](#) [P1100EAL](#) [P2600EAL](#) [P1300EAL](#) [P1500EAL](#) [P2600EBL](#) [P1800EAL](#) [P0640EBL](#) [P0640ECL](#) [P1800SA](#)
[P1800EC](#) [P1300SA](#) [P1300SB](#) [P1300SC](#) [P0900SA](#) [P0900EC](#) [P1300EB](#) [P2600EA](#) [P3100EA](#) [P1500EA](#) [P0300EA](#)
[P0900SC](#) [P0900EB](#) [P0900SB](#) [P0900EA](#) [P1300ECL](#) [P1800ECL](#) [P1300EC](#) [P1500EC](#) [P1100EC](#) [P1800SB](#)
[P1800SC](#) [P0300SA](#) [P0300ECL](#) [P0300EB](#) [P0300SB](#) [P0300SC](#) [P0300EC](#) [P0900EAL](#) [P1500SB](#) [P1100SB](#)
[P3100SB](#) [P2600SB](#) [P3500SB](#) [P2300SB](#) [P3100EB](#) [P0080EB](#) [P0640EAL](#) [P0720EC](#) [P0720SA](#) [P3100EBL](#)
[P3500EBL](#) [P2300EBL](#) [P1100EB](#) [P3500EB](#) [P1800EB](#) [P1500EB](#) [P3100EAL](#) [P0300EAL](#) [P2600SA](#) [P2600EC](#)
[P2600SC](#) [P2600EB](#) [P3100ECL](#) [P3500ECL](#) [P3100EC](#) [P3100SC](#) [P3100SA](#) [P0080EA](#) [P0080EC](#) [P0640EC](#)
[P2600ECL](#) [P1100ECL](#) [P2300ECL](#) [P0640EB](#) [P0720EB](#) [P2300EAL](#) [P1300EBL](#) [P1500ECL](#) [P0080SA](#) [P1100EA](#)
[P3500EAL](#) [P2300EC](#) [P2300EA](#) [P2300EB](#) [P1800EA](#) [P1300EA](#) [P0640SA](#) [P0640SB](#) [P1800EBL](#) [P0640SC](#)
[P0640EA](#) [P1100EBL](#) [P0720EA](#) [P0720EAL](#) [P3500SC](#) [P3500SA](#) [P1500EBL](#) [P3500EA](#) [P3500EC](#)