

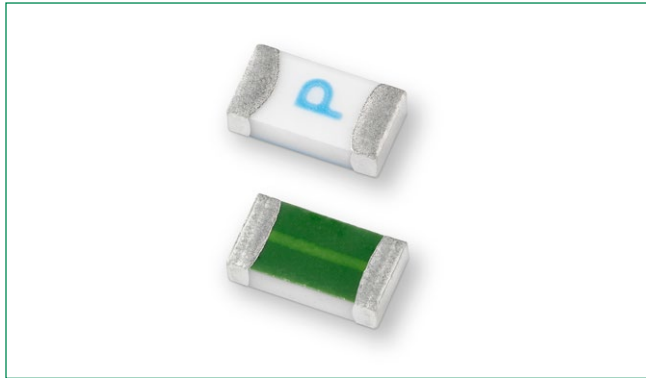

440A Series, 1206 High I²t Fuse



Agency Approvals

Agency	Agency File Number	Ampere Range
	E10480	0.500A - 8A
	29862	0.500A - 8A

Electrical Characteristics for Series

% of Ampere Rating	Ampere Rating	Opening Time at 25°C
100%	0.50A - 0.75A 1.75A - 8A	4 hours, Minimum
350%	0.50A - 0.75A 1.75A - 8A	5 secs., Maximum

Description

The 440A Series AECQ-Compliant fuses are specifically tested to cater to secondary circuit protection needs of compact auto electronics applications.

The general design ensures excellent temperature stability and performance reliability. This high I²t fuse series is designed to have ultra high inrush current withstand capability to avoid nuisance fuse open.

Features

- Operating Temperature from -55°C to +150°C
- 100% Lead-free, RoHS compliant and Halogen-free
- Meets Littelfuse's automotive qualifications*
- Ultra high I²t values
- Fast response to over-current to ensure faulty component protection to sensitive electronic component

* - Largely based on Littelfuse internal AEC-Q200 test plan.

Applications

- Li-ion Battery
- LED Lighting
- Automotive Navigation System
- TFT Display
- Battery Management System (BMS)
- Cluster

Additional Information



Datasheet





Resources



Samples

Electrical Specifications by Item

Ampere Rating (A)	Amp Code	Max. Voltage Rating (V)	Interrupting Rating (AC/DC) ¹	Nominal Resistance (Ohms) ²	Nominal Melting I ² t (A ² Sec.) ³	Nominal Voltage Drop At Rated Current (V) ⁴	Nominal Power Dissipation At Rated Current (W)	Agency Approvals	
									
0.5	.500	63	50A @ 63VAC/DC	0.8140	0.02642	0.4831	0.242	x	X
0.75	.750	63		0.4624	0.09312	0.3983	0.299	x	X
1.75	1.75	63		0.0450	0.3312	0.0777	0.136	x	X
2	002.	63		0.0385	0.4326	0.0792	0.158	x	X
2.5	02.5	63	50A @ 32VAC/63VDC	0.02850	0.8191	0.0747	0.187	x	X
3	003.	63		0.02252	1.232	0.0742	0.223	x	X
3.5	03.5	63		0.01845	1.789	0.0757	0.265	x	X
4	004.	63		0.01553	2.601	0.0709	0.284	x	X
5	005.	63		0.0120	4.761	0.0654	0.327	x	X
7	007.	63		0.00753	8.464	0.0696	0.487	x	X
8	008.	63		0.00634	12.95	0.0655	0.524	x	X

Notes:

1. AC Interrupting Rating tested at rated voltage with unity power factor. DC Interrupting Rating tested at rated voltage with time constant < 0.8 msec.
2. Nominal Resistance measured with < 10% rated current.
3. Nominal Melting I²t measured at 1msec. opening time.
4. Nominal Voltage Drop measured at rated current after temperature has stabilized.

Devices designed to carry rated current for 4 hours minimum. It is recommended that devices be operated continuously at no more than 80% rated current. See "Temperature Derating Curve" for additional derating information.

Devices designed to be mounted with marking code facing up.

Temperature Derating Curve

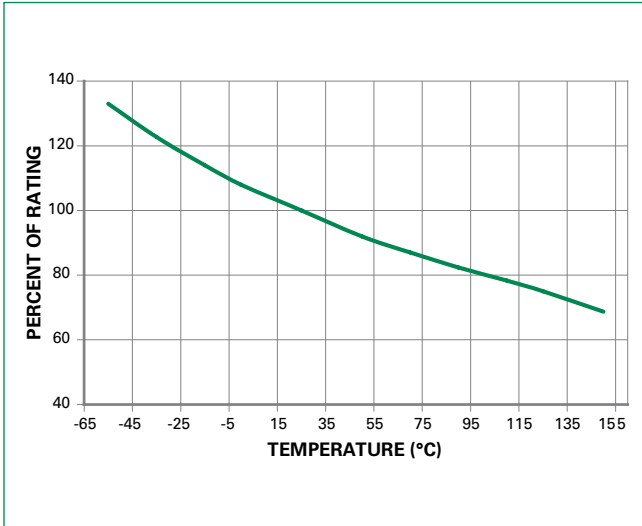

Note:

1. Derating depicted in this curve is in addition to the standard derating of 20% for continuous operation.

Example:

For continuous operation at 75 degrees celsius, the fuse should be derated as follows:

$$I = (0.80)(0.85)I_{RAT} = (0.68)I_{RAT}$$

Average Time Current Curves

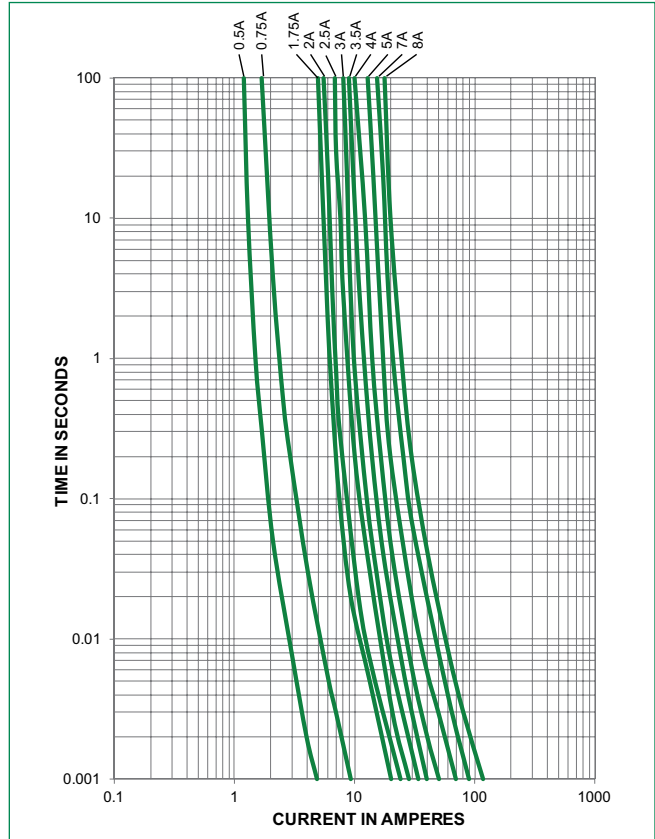

Soldering Parameters

Reflow Condition		Pb-free assembly
Pre Heat	- Temperature Min ($T_{S(min)}$)	150°C
	- Temperature Max ($T_{S(max)}$)	200°C
	- Time (Min to Max) (t_s)	60 – 180 seconds
Average Ramp-Up Rate (Liquidus Temp (T_L) to peak)		3°C/second max.
$T_{S(max)}$ to T_L - Ramp-up Rate		5°C/second max.
Reflow	- Temperature (T_L) (Liquidus)	217°C
	- Temperature (t_L)	60 – 150 seconds
Peak Temperature (T_p)		260 ^{+0/-5} °C
Time within 5°C of actual peak Temperature (t_p)		10 – 30 seconds
Ramp-down Rate		6°C/second max.
Time 25°C to peak Temperature (T_p)		8 minutes max.
Do not exceed		260°C

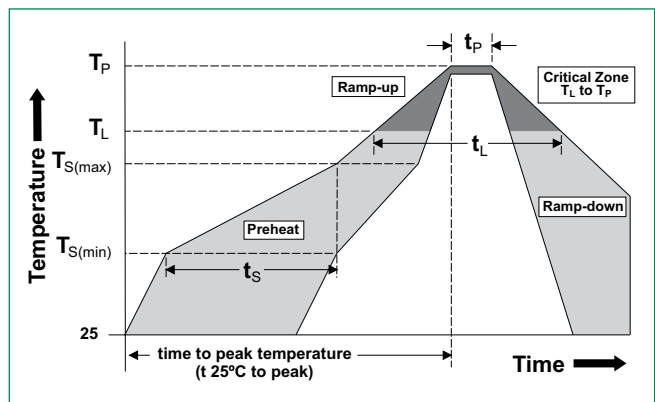

Wave Soldering

260°C, 10 seconds max.

Product Characteristics

Materials	Body: Advanced Ceramic Terminations: Ag / Ni / Sn (100% Lead-free) Element Cover Coating: Lead-free Glass
Moisture Sensitivity Level	IPC/JEDEC J-STD-020, Level 1
Solderability	IPC/ECA/JEDEC J-STD-002, Condition C
Humidity Test	MIL-STD-202, Method 103, Conditions D
Resistance to Solder Heat	MIL-STD-202, Method 210, Condition B
Moisture Resistance	MIL-STD-202, Method 106
Thermal Shock	MIL-STD-202, Method 107, Condition B
Mechanical Shock	MIL-STD-202, Method 213, Condition A
Vibration	MIL-STD-202, Method 201
Vibration, High Frequency	MIL-STD-202, Method 204, Condition D
Dissolution of Metallization	IPC/ECA/JEDEC J-STD-002, Condition D
Terminal Strength	IEC 60127-4

High Temperature Storage	MIL-STD-202, Method 108 with exemptions
Thermal Shock Test	JESD22 Method JA-104, Test Conditions B and N
Biased Humidity	MIL-STD-202, Method 103, 85C/85% RH with 10% operating power for 1000 hrs
Operational Life	MIL-STD-202, Method 108, Test Condition D
Resistance to Solvents	MIL-STD-202, Method 215
Mechanical Shock	MIL-STD-202, Method 213, Test Condition C
High Frequency Vibration	MIL-STD-202, Method 204
Resistance to Soldering Heat	MIL-STD-202, Method 210, Test Condition B
Solderability	JESD22-B102E Method 1
Terminal Strength for SMD	AEC Q200-006
Board Flex	AEC Q200-005
Electrical Characterization	3 Temperature Electrical

Dimensions

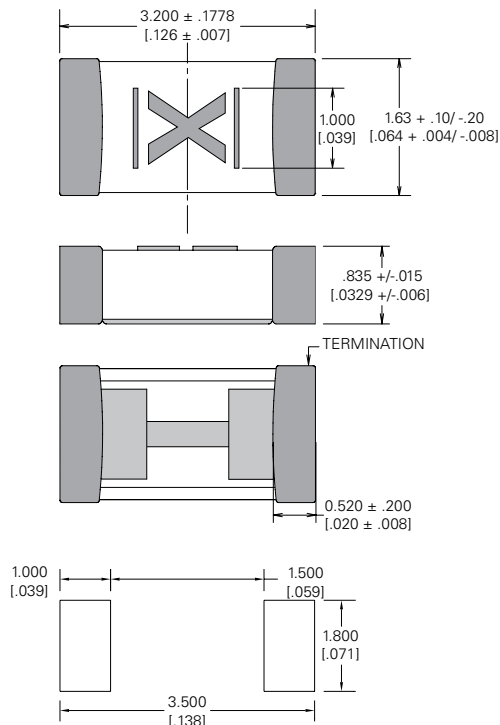

Part Marking System

Amp Code	Marking Code
0.500	F
0.750	G
1.75	L
002.0	N
02.5	O
003.0	P
03.5	R
004.0	S
005.0	T
007.0	W
008.0	X

Part Numbering System

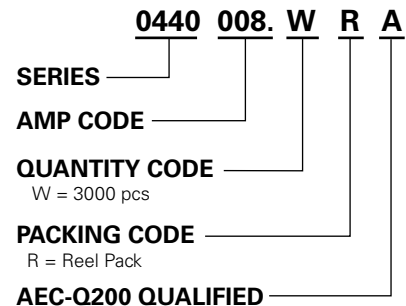

Packaging

Packaging Option	Packaging Specification	Quantity	Quantity and Packaging Code
8mm Tape and Reel	EIA-481, IEC 60286, Part 3	3000	WRA

Mouser Electronics

Authorized Distributor

Click to View Pricing, Inventory, Delivery & Lifecycle Information:

Littelfuse:

[04401.75WRA](#) [044002.5WRA](#) [0440002.WRA](#) [0440005.WRA](#) [0440008.WRA](#) [0440007.WRA](#) [0440.500WRA](#)
[0440.750WRA](#) [044003.5WRA](#) [0440003.WRA](#) [0440004.WRA](#)