

# GenX3™ 600V IGBTs

# IXGK120N60B3\* IXGX120N60B3

\*Obsolete Part Number

Medium-Speed-Low-Vsat PT  
IGBTs for 5-40kHz Switching

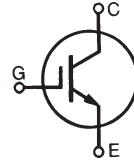

$V_{CES} = 600V$   
 $I_{C110} = 120A$   
 $V_{CE(sat)} \leq 1.8V$   
 $t_{fi(typ)} = 145ns$

Symbol	Test Conditions	Maximum Ratings	
$V_{CES}$	$T_J = 25^\circ C$ to $150^\circ C$	600	V
$V_{CGR}$	$T_J = 25^\circ C$ to $150^\circ C$ , $R_{GE} = 1M\Omega$	600	V
$V_{GES}$	Continuous	$\pm 20$	V
$V_{GEM}$	Transient	$\pm 30$	V
$I_{C25}$	$T_C = 25^\circ C$ (Chip Capability)	280	A
$I_{C110}$	$T_C = 110^\circ C$	120	A
$I_{LRMS}$	Terminal Current Limit	160	A
$I_{CM}$	$T_C = 25^\circ C$ , 1ms	600	A
<b>SSOA</b> <b>(RBSOA)</b>	$V_{GE} = 15V$ , $T_{VJ} = 125^\circ C$ , $R_G = 2\Omega$ Clamped Inductive Load	$I_{CM} = 300$ $V_{CE} \leq V_{CES}$	A
$P_C$	$T_C = 25^\circ C$	780	W
$T_J$		-55 ... +150	$^\circ C$
$T_{JM}$		150	$^\circ C$
$T_{stg}$		-55 ... +150	$^\circ C$
$T_L$	Maximum Lead Temperature for Soldering	300	$^\circ C$
$T_{SOLD}$	1.6 mm (0.062 in.) from Case for 10	260	$^\circ C$
$M_d$	Mounting Torque (IXGK)	1.13/10	Nm/lb.in.
$F_c$	Mounting Force (IXGX)	20..120/4.5..27	N/lb.
<b>Weight</b>	TO-264	10	g
	PLUS247	6	g

TO-264 (IXGK)

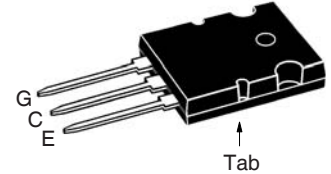

PLUS247™ (IXGX)

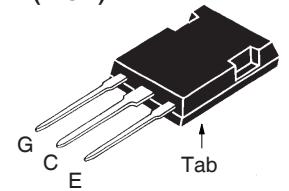

G = Gate                      E = Emitter  
 C = Collector                Tab = Collector

### Features

- Optimized for Low Conduction and Switching Losses
- Square RBSOA
- High Current Handling Capability
- International Standard Packages

### Advantages

- High Power Density
- Low Gate Drive Requirement

### Applications

- Power Inverters
- UPS
- Motor Drives
- SMPS
- PFC Circuits
- Battery Chargers
- Welding Machines
- Lamp Ballasts

Symbol	Test Conditions ( $T_J = 25^\circ C$ , Unless Otherwise Specified)	Characteristic Values		
		Min.	Typ.	Max.
$BV_{CES}$	$I_C = 250\mu A$ , $V_{GE} = 0V$	600		V
$V_{GE(th)}$	$I_C = 500\mu A$ , $V_{CE} = V_{GE}$	3.0		5.0 V
$I_{CES}$	$V_{CE} = V_{CES}$ , $V_{GE} = 0V$ $T_J = 125^\circ C$			50 $\mu A$ 3 mA
$I_{GES}$	$V_{CE} = 0V$ , $V_{GE} = \pm 20V$			$\pm 100$ nA
$V_{CE(sat)}$	$I_C = 100A$ , $V_{GE} = 15V$ , Note 1		1.5	1.8 V

Symbol	Test Conditions ( $T_J = 25^\circ\text{C}$ , Unless Otherwise Specified)	Characteristic Values		
		Min.	Typ.	Max.
$g_{fs}$	$I_C = 60\text{A}$ , $V_{CE} = 10\text{V}$ , Note 1	100	170	S
$C_{ies}$	$V_{CE} = 25\text{V}$ , $V_{GE} = 0\text{V}$ , $f = 1\text{MHz}$		14.6	nF
$C_{oes}$			790	pF
$C_{res}$			140	pF
$Q_g$	$I_C = 120\text{A}$ , $V_{GE} = 15\text{V}$ , $V_{CE} = 0.5 \cdot V_{CES}$		465	nC
$Q_{ge}$			74	nC
$Q_{gc}$			167	nC
$t_{d(on)}$	<b>Inductive load, <math>T_J = 25^\circ\text{C}</math></b> $I_C = 100\text{A}$ , $V_{GE} = 15\text{V}$ $V_{CE} = 480\text{V}$ , $R_G = 2\Omega$ Note 2		40	ns
$t_{ri}$			87	ns
$E_{on}$			2.9	mJ
$t_{d(off)}$			227	ns
$t_{fi}$			145	ns
$E_{off}$			3.5	mJ
$t_{d(on)}$	<b>Inductive load, <math>T_J = 125^\circ\text{C}</math></b> $I_C = 100\text{A}$ , $V_{GE} = 15\text{V}$ $V_{CE} = 480\text{V}$ , $R_G = 2\Omega$ Note 2		38	ns
$t_{ri}$			85	ns
$E_{on}$			4.0	mJ
$t_{d(off)}$			290	ns
$t_{fi}$			230	ns
$E_{off}$			4.7	mJ
$R_{thJC}$			0.16	$^\circ\text{C/W}$
$R_{thCS}$			0.15	$^\circ\text{C/W}$

### TO-264 AA (IXGK) Outline

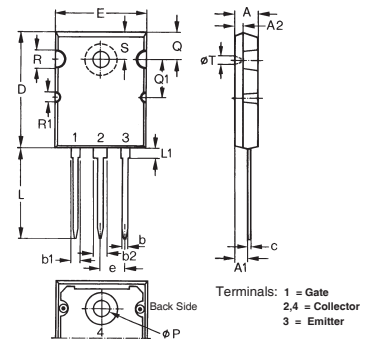

Dim.	Millimeter		Inches	
	Min.	Max.	Min.	Max.
A	4.82	5.13	.190	.202
A1	2.54	2.89	.100	.114
A2	2.00	2.10	.079	.083
b	1.12	1.42	.044	.056
b1	2.39	2.69	.094	.106
b2	2.90	3.09	.114	.122
c	0.53	0.83	.021	.033
D	25.91	26.16	1.020	1.030
E	19.81	19.96	.780	.786
e	5.46 BSC .215 BSC			
J	0.00	0.25	.000	.010
K	0.00	0.25	.000	.010
L	20.32	20.83	.800	.820
L1	2.29	2.59	.090	.102
P	3.17	3.66	.125	.144
Q	6.07	6.27	.239	.247
Q1	8.38	8.69	.330	.342
R	3.81	4.32	.150	.170
R1	1.78	2.29	.070	.090
S	6.04	6.30	.238	.248
T	1.57	1.83	.062	.072

### Notes:

1. Pulse test,  $t \leq 300\mu\text{s}$ , duty cycle,  $d \leq 2\%$ .
2. Switching times & energy losses may increase for higher  $V_{CE}(\text{Clamp})$ ,  $T_J$  or  $R_G$ .

### PLUS247™ (IXGX) Outline

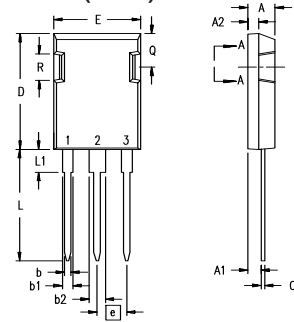

Terminals: 1 - Gate  
2 - Collector  
3 - Emitter

Dim.	Millimeter		Inches	
	Min.	Max.	Min.	Max.
A	4.83	5.21	.190	.205
A <sub>1</sub>	2.29	2.54	.090	.100
A <sub>2</sub>	1.91	2.16	.075	.085
b	1.14	1.40	.045	.055
b <sub>1</sub>	1.91	2.13	.075	.084
b <sub>2</sub>	2.92	3.12	.115	.123
C	0.61	0.80	.024	.031
D	20.80	21.34	.819	.840
E	15.75	16.13	.620	.635
e	5.45 BSC .215 BSC			
L	19.81	20.32	.780	.800
L1	3.81	4.32	.150	.170
Q	5.59	6.20	.220	0.244
R	4.32	4.83	.170	.190

IXYS Reserves the Right to Change Limits, Test Conditions, and Dimensions.

IXYS MOSFETs and IGBTs are covered by one or more of the following U.S. patents:	4,835,592	4,931,844	5,049,961	5,237,481	6,162,665	6,404,065 B1	6,683,344	6,727,585	7,005,734 B2	7,157,338B2
	4,850,072	5,017,508	5,063,307	5,381,025	6,259,123 B1	6,534,343	6,710,405 B2	6,759,692	7,063,975 B2	
	4,881,106	5,034,796	5,187,117	5,486,715	6,306,728 B1	6,583,505	6,710,463	6,771,478 B2	7,071,537	

**Fig. 1. Output Characteristics @  $T_J = 25^\circ\text{C}$**

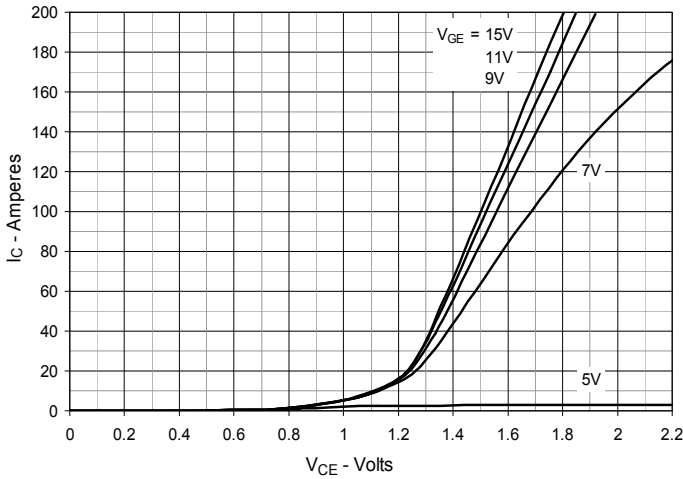

**Fig. 2. Extended Output Characteristics @  $T_J = 25^\circ\text{C}$**

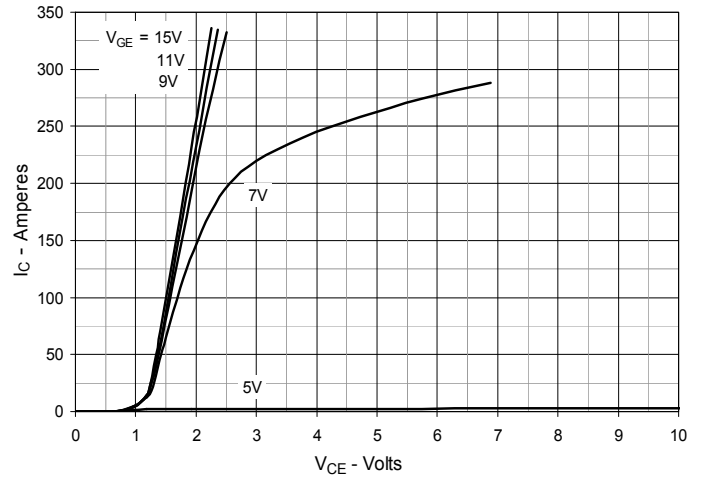

**Fig. 3. Output Characteristics @  $T_J = 125^\circ\text{C}$**

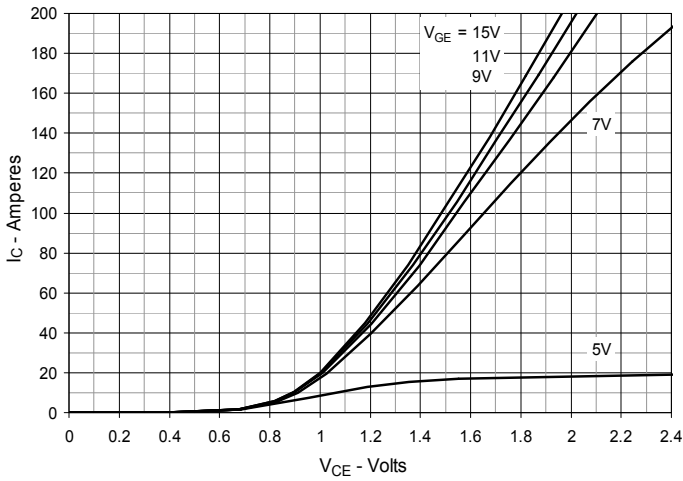

**Fig. 4. Dependence of  $V_{CE(sat)}$  on Junction Temperature**

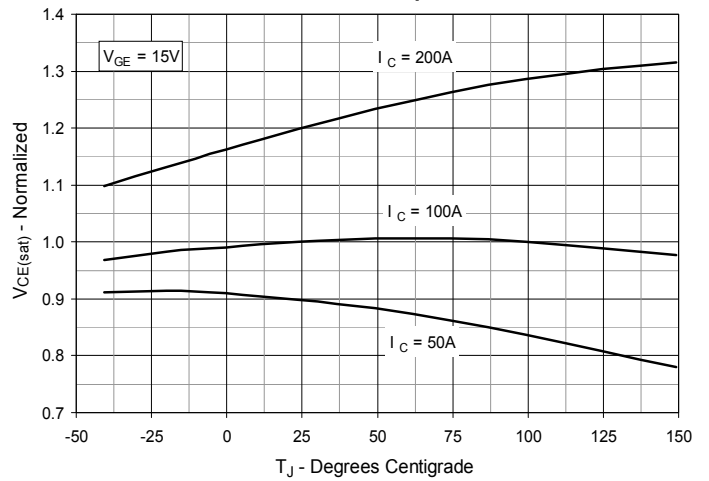

**Fig. 5. Collector-to-Emitter Voltage vs. Gate-to-Emitter Voltage**

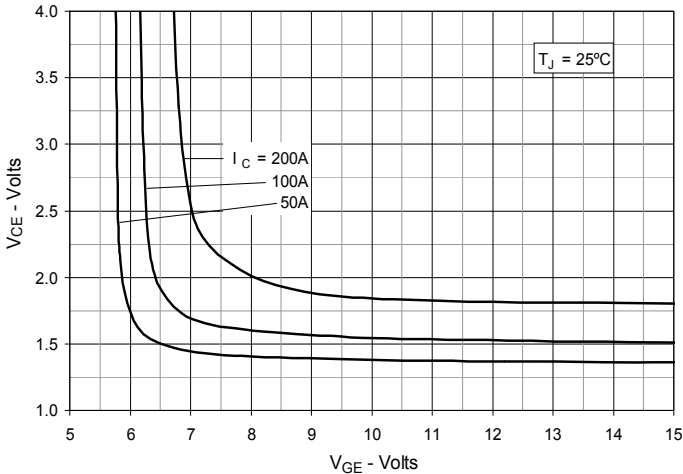

**Fig. 6. Input Admittance**

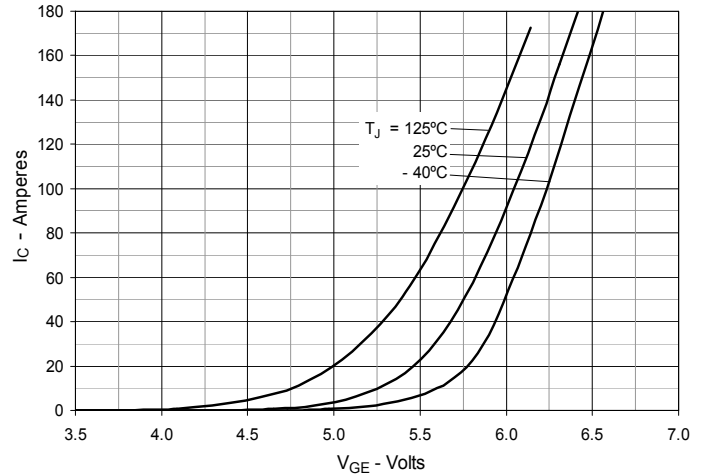

Fig. 7. Transconductance

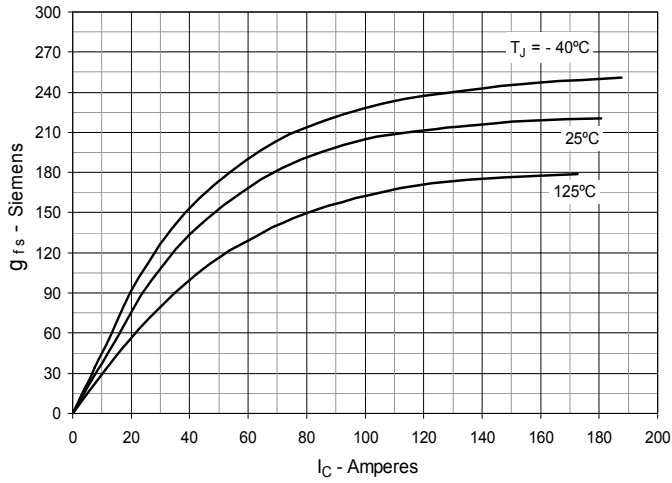

Fig. 8. Gate Charge

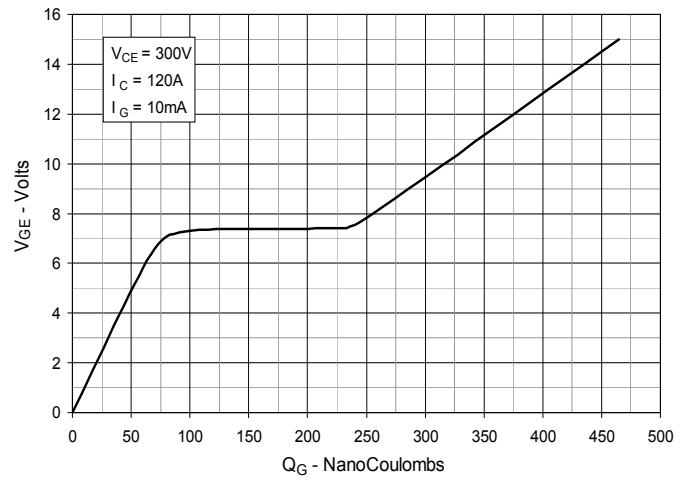

Fig. 9. Capacitance

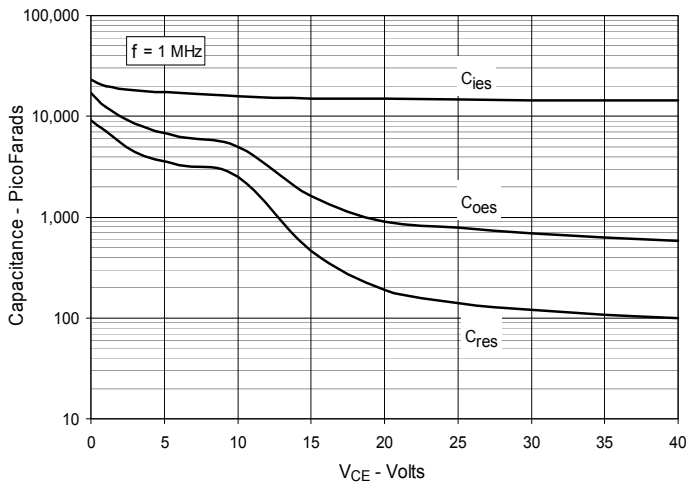

Fig. 10. Reverse-Bias Safe Operating Area

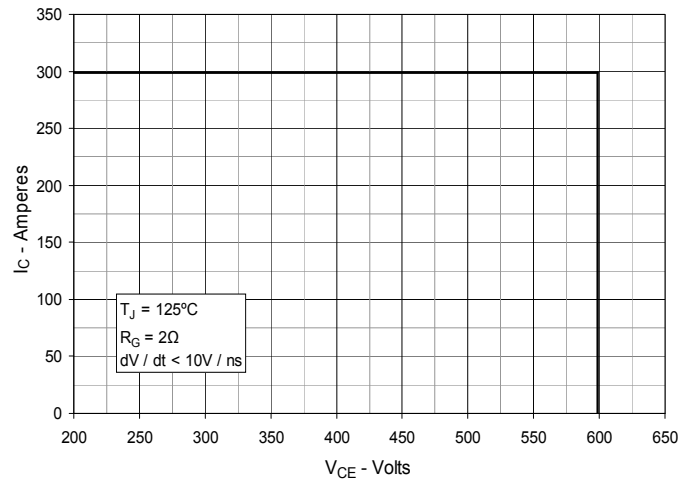
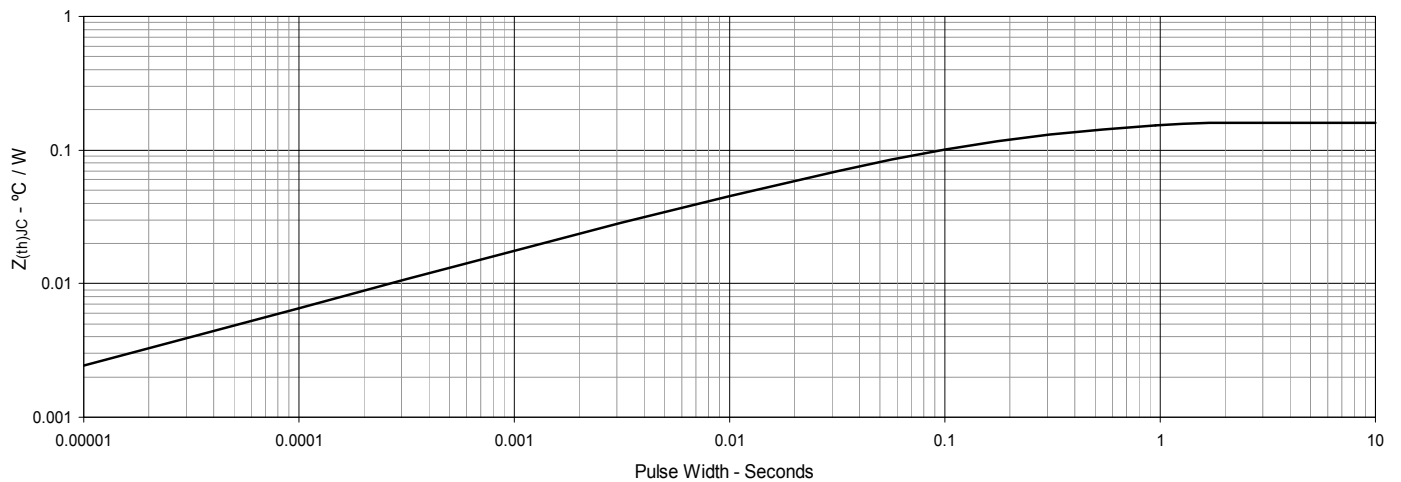
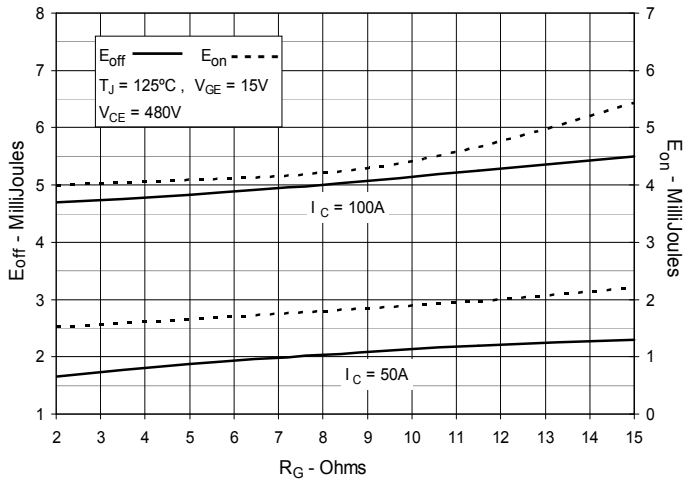

Fig. 11. Maximum Transient Thermal Impedance



**Fig. 12. Inductive Switching Energy Loss vs. Gate Resistance**



**Fig. 13. Inductive Switching Energy Loss vs. Collector Current**

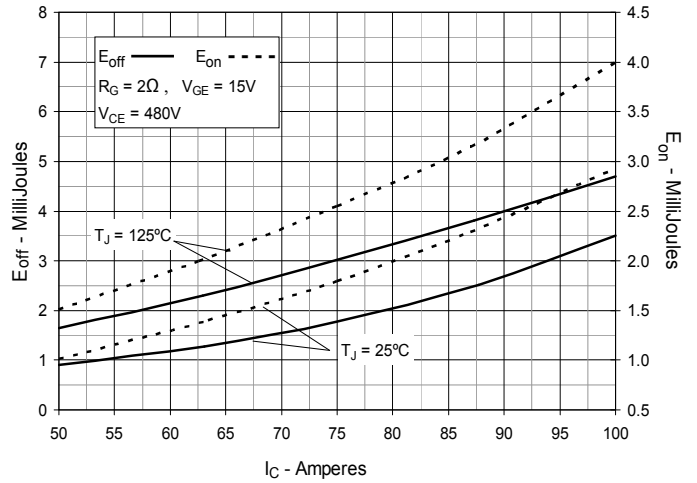

**Fig. 14. Inductive Switching Energy Loss vs. Junction Temperature**

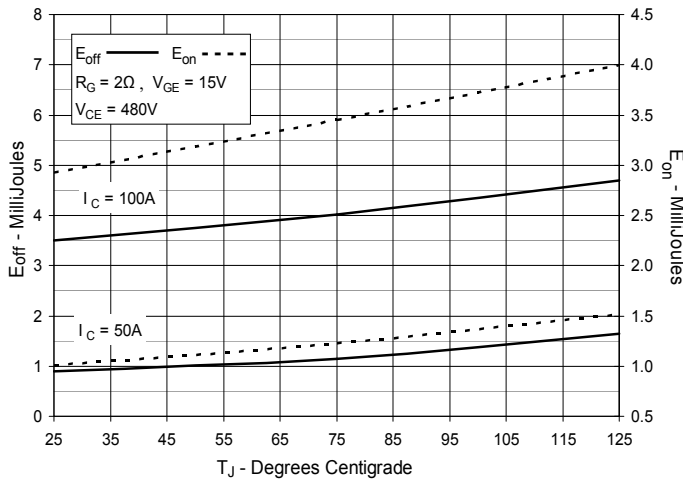

**Fig. 15. Inductive Turn-off Switching Times vs. Gate Resistance**

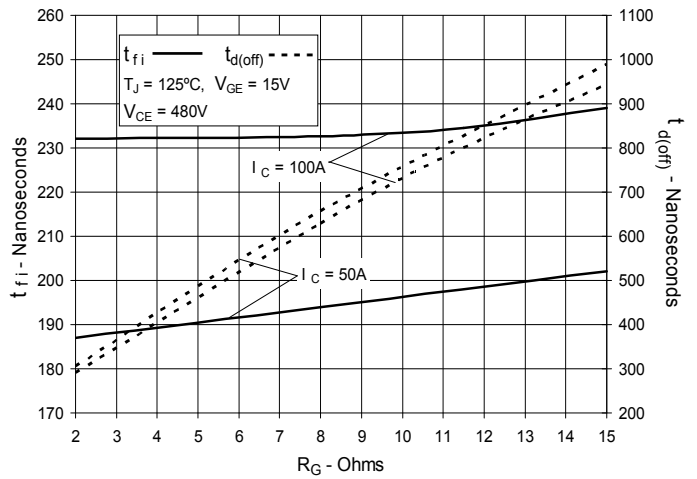

**Fig. 16. Inductive Turn-off Switching Times vs. Collector Current**

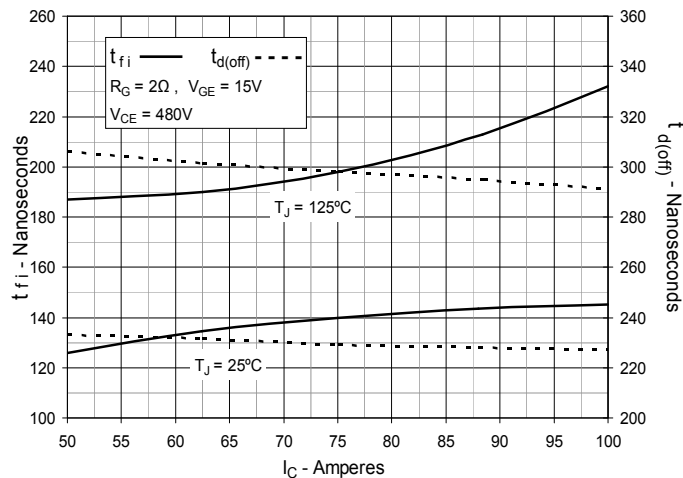

**Fig. 17. Inductive Turn-off Switching Times vs. Junction Temperature**

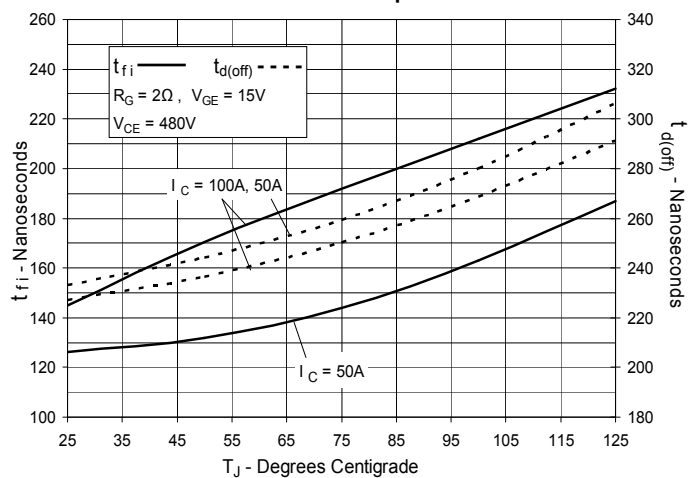

**Fig. 18. Inductive Turn-on Switching Times vs. Gate Resistance**

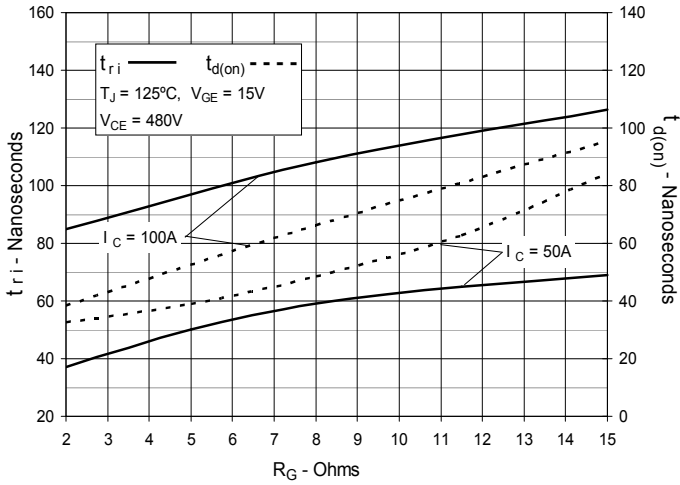

**Fig. 19. Inductive Turn-on Switching Times vs. Collector Current**

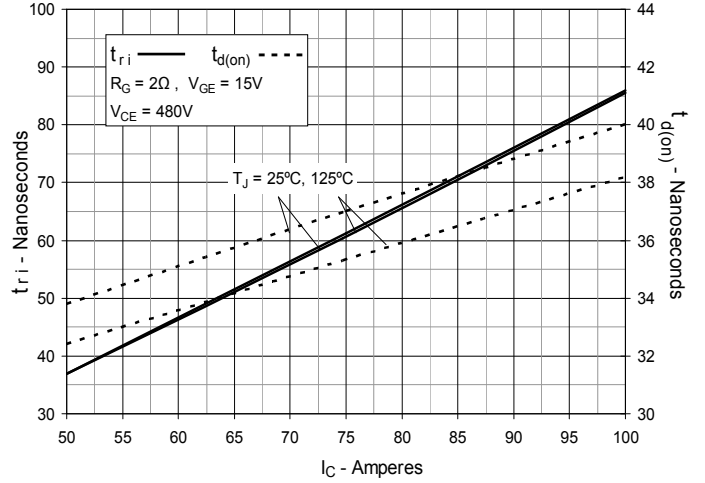

**Fig. 20. Inductive Turn-on Switching Times vs. Junction Temperature**

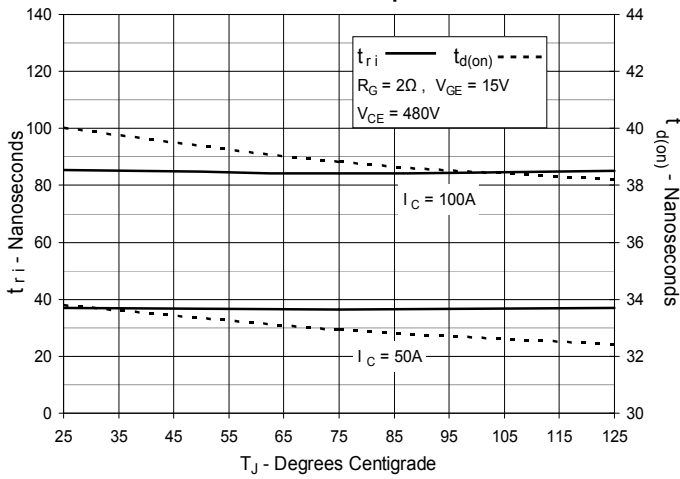



---

Disclaimer Notice - Information furnished is believed to be accurate and reliable. However, users should independently evaluate the suitability of and test each product selected for their own applications. Littelfuse products are not designed for, and may not be used in, all applications. Read complete Disclaimer Notice at [www.littelfuse.com/disclaimer-electronics](http://www.littelfuse.com/disclaimer-electronics).

# Mouser Electronics

Authorized Distributor

Click to View Pricing, Inventory, Delivery & Lifecycle Information:

[IXYS:](#)

[IXGX120N60B3](#) [IXGK120N60B3](#)