



Photocoupler
Product Data Sheet
6N137-L series

Spec No. :DS70-2008-0035
Effective Date: 10/17/2017
Revision: D

LITE-ON DCC

RELEASE

BNS-OD-FC001/A4

Photocoupler 6N137-L series

1. DESCRIPTION

The 6N137-L consists of a high efficient AlGaAs Light Emitting Diode and a high speed optical detector. This design provides excellent AC and DC isolation between the input and output sides of the Optocoupler. The output of the optical detector features an open collector Schottky clamped transistor. The enable function allows the optical detector to be strobed. A guaranteed common mode transient immunity is up to 10kV/ μ s at 3.3V.

The Optocoupler operational parameters are guaranteed over the temperature range from -40°C ~ +85°C.

1.1 Features

- 3.3V / 5V Dual Supply Voltages
- Low power consumption
- High speed – 15MBd typical
- 10kV/ μ s minimum Common Mode Rejection (CMR) at $V_{CM} = 1000V$
- Guaranteed AC and DC performance over temperature -40°C ~ +85°C.
- LVTTTL/LVCMOS Compatible.
- Available in Dual-in-line, Wide lead spacing, Surface mounting package.
- Strobable output.
- Safety approval
UL/ cUL 1577, 5000 Vrms/1 min
VDE DIN EN60747-5-5, $V_{IORM} = 567 V_{peak}$

1.2 Applications

- Isolation in line receivers
- Digital isolation for A/D, D/A conversion
- Ground loop elimination
- Feedback Element in Switching Mode Power Supplier
- Pulse transformer replacement
- Power transistor isolation in motor drives
- Interface between Microprocessor system, computer and their peripheral

1.3 Functional Diagram

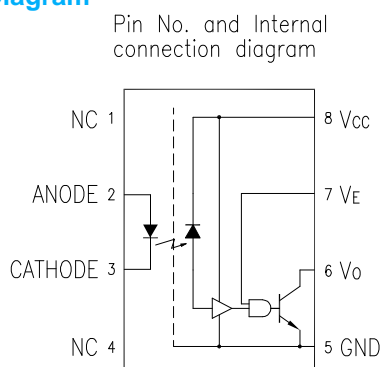

Truth Table (Positive Logic)

LED	ENABLE	OUT
ON	H	L
OFF	H	H
ON	L	H
OFF	L	H
ON	NC	L
OFF	NC	H

A 0.1 μ F bypass Capacitor must be connected between Pin8 and Pin5

Photocoupler 6N137-L series

2. PACKAGE DIMENSIONS

2.1 6N137-L

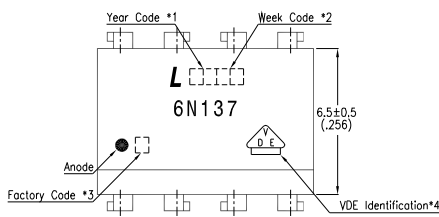

2.2 6N137M-L

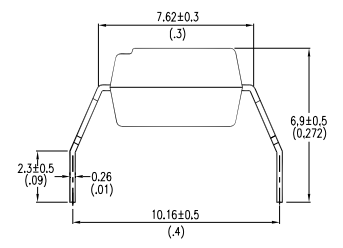
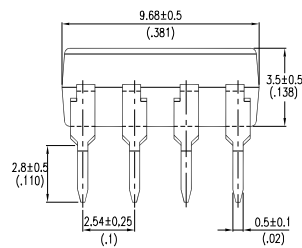
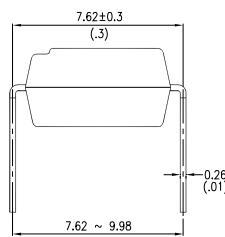
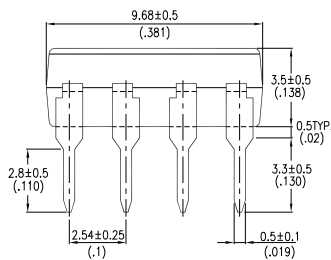
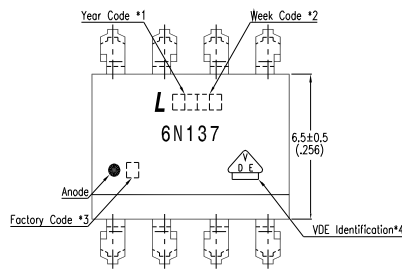

2.3 6N137S-L

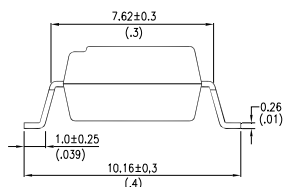
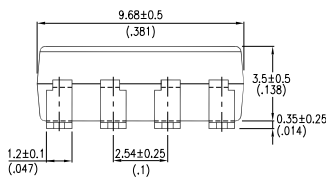
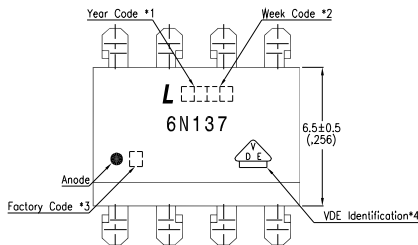

Notes :

1. Year date code.
2. 2-digit work week.
3. Factory identification mark shall be marked (W: China-CZ, Y: Thailand)
4. VDE option.

Dimensions in millimeters (inches).

Photocoupler 6N137-L series

3. TAPING DIMENSIONS

3.1 : 6N137S-TA-L

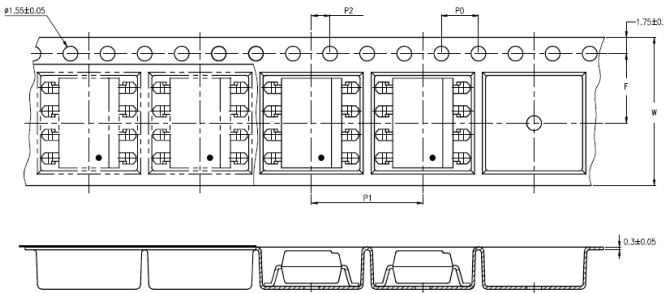

3.2 : 6N137S-TA1-L

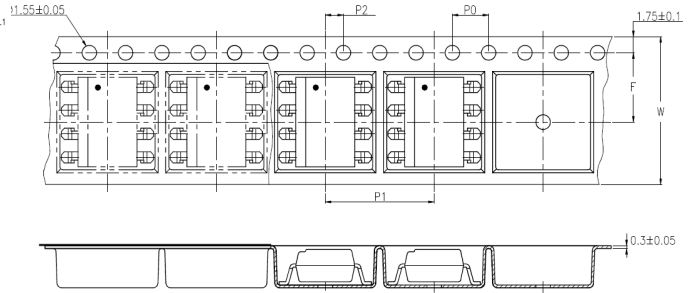

Description	Symbol	Dimension in mm (inch)
Tape wide	W	16±0.3 (0.63)
Pitch of sprocket holes	P ₀	4±0.1 (0.15)
Distance of compartment	F	7.5±0.1 (0.295)
	P ₂	2±0.1 (0.079)
Distance of compartment to compartment	P ₁	12±0.1 (0.472)

3.3 Quantities Per Reel

Package Type	TA/TA1
Quantities (pcs)	1000

Photocoupler 6N137-L series

4. RATING AND CHARACTERISTICS

4.1 Absolute Maximum Ratings at Ta=25°C *1

	Parameter	Symbol	Rating	Unit	Note
Input	Average Forward Input Current	I_F	20	mA	2
	Reverse Input Voltage	V_R	5	V	
	Power Dissipation	P_I	40	mW	
	Enable Input Voltage	V_E	$V_{CC}+0.5$	V	
	Enable Input current	I_E	5	mA	
Output	Output Collector Current	I_O	50	mA	
	Output Collector Voltage	V_O	7	V	
	Output Collector Power Dissipation	P_O	85	mW	
	Isolation Voltage	V_{iso}	5000	V_{rms}	
	Supply Voltage	V_{CC}	7	V	
	Operating Temperature	T_{opr}	-40 ~ +85	°C	
	Storage Temperature	T_{stg}	-55 ~ +125	°C	
	Lead Solder Temperature *2	T_{sol}	260	°C	

1. Ambient temperature = 25°C, unless otherwise specified. Stresses exceeding the absolute maximum ratings can cause permanent damage to the device. Exposure to absolute maximum ratings for long periods of time can adversely affect reliability.
2. 260°C for 10 seconds. Refer to Lead Free Reflow Profile.

Photocoupler 6N137-L series

4.2 Recommended Operating Conditions

Parameter	Symbol	Min	Max	Unit
Operating Temperature	T_A	-40	85	°C
Supply Voltage	V_{CC}	2.7	3.6	V
		4.5	5.5	
Low Level Input Current	I_{FL}	0	250	μA
High Level Input Current	I_{FH}	5	15	mA
Low Level Enable Voltage	V_{EL}	0	0.8	V
High Level Enable Voltage	V_{EH}	2	V_{CC}	V
Output Pull-up Resistor	R_L	330	4k	Ω
Fan Out (at $R_L=1k\Omega$ per channel)	N	—	5	TTL Loads

Photocoupler 6N137-L series

4.3 ELECTRICAL OPTICAL CHARACTERISTICS at Ta = 25°C

Parameter	Symbol	Min.	Typ.	Max.	Unit	Test Condition
Input						
Input Forward Voltage	V_F	—	1.38	1.70	V	$I_F = 10\text{mA}$
Input Forward Voltage Temperature Coefficient	$\Delta V_F / \Delta T$	—	-1.5	—	mV/°C	$I_F = 10\text{mA}$
Input Reverse Voltage	BV_R	5.0	—	—	V	$I_R = 10\mu\text{A}$
Input Threshold Current	I_{TH}	—	1.5	5	mA	$V_E = 2\text{V}, V_{CC} = 3.3\text{V}, V_O = 0.6\text{V}, I_{OL}(\text{sinking}) = 13\text{mA}$
Input Capacitance	C_{IN}	—	34	—	pF	$f = 1\text{MHz}, V_F = 0\text{V}$
Detector						
High Level Supply Current	I_{CCH}	—	3.8	7	mA	$V_E = 0.5\text{V}, V_{CC} = 3.3\text{V}, I_F = 0\text{mA}$
Low Level Supply Current	I_{CCL}	—	5.8	10	mA	$V_E = 0.5\text{V}, V_{CC} = 3.3\text{V}, I_F = 10\text{mA}$
High Level Enable Current	I_{EH}	—	-0.19	-1.6	mA	$V_{CC} = 3.3\text{V}, V_E = 2\text{V}$
Low Level Enable Current	I_{EL}	—	-0.41	-1.6	mA	$V_{CC} = 3.3\text{V}, V_E = 0.5\text{V}$
High Level Enable Voltage	V_{EH}	2	—	—	V	
Low Level Enable Voltage	V_{EL}	—	—	0.8	V	
High Level Output Current	I_{OH}	—	5	100	μA	$V_E = 2\text{V}, V_{CC} = 3.3\text{V}, V_O = 3.3\text{V}, I_F = 250\mu\text{A}$
Low Level Output Voltage	V_{OL}	—	0.3	0.60	V	$V_E = 2\text{V}, V_{CC} = 3.3\text{V}, I_F = 5\text{mA}, I_{OL}(\text{sinking}) = 13\text{mA}$

Specified over recommended temperature ($T_A = -40^\circ\text{C}$ to $+85^\circ\text{C}$, $2.7\text{V} \leq V_{CC} \leq 3.6\text{V}$), $I_F = 7.5\text{mA}$ unless otherwise specified. All typicals at $T_A = 25^\circ\text{C}$, $V_{CC} = 3.3\text{V}$.

Photocoupler 6N137-L series

Parameter	Symbol	Min.	Typ.	Max.	Unit	Test Condition
Input						
Input Forward Voltage	V_F	—	1.38	1.70	V	$I_F = 10\text{mA}$
Input Forward Voltage Temperature Coefficient	$\Delta V_F / \Delta T$	—	-1.5	—	mV/°C	$I_F = 10\text{mA}$
Input Reverse Voltage	BV_R	5.0	—	—	V	$I_R = 10\mu\text{A}$
Input Threshold Current	I_{TH}	—	1.35	5	mA	$V_{CC} = 5.5\text{V}$, $V_O = 0.6\text{V}$ $I_{OL} > 13\text{mA}$
Input Capacitance	C_{IN}	—	34	—	pF	$f = 1\text{MHz}$, $V_F = 0\text{V}$
Detector						
High Level Supply Current	I_{CCH}	—	6.1	10	mA	$V_E = 0.5\text{V}$, $V_{CC} = 5.5\text{V}$, $I_F = 0\text{mA}$
Low Level Supply Current	I_{CCL}	—	8.3	13	mA	$V_E = 0.5\text{V}$, $V_{CC} = 5.5\text{V}$, $I_F = 10\text{mA}$
High Level Enable Current	I_{EH}	—	-0.6	-1.6	mA	$V_{CC} = 5.5\text{V}$, $V_E = 2\text{V}$
Low Level Enable Current	I_{EL}	—	-0.9	-1.6	mA	$V_{CC} = 5.5\text{V}$, $V_E = 0.5\text{V}$
High Level Enable Voltage	V_{EH}	2	—	—	V	
Low Level Enable Voltage	V_{EL}	—	—	0.8	V	
High Level Output Current	I_{OH}	—	0.9	100	μA	$V_E = 2\text{V}$, $V_{CC} = 5.5\text{V}$, $V_O = 5.5\text{V}$, $I_F = 250\mu\text{A}$
Low Level Output Voltage	V_{OL}	—	0.4	0.60	V	$V_{CC} = 5.5\text{V}$, $I_F = 5\text{mA}$, $I_{OL} (\text{sinking}) = 13\text{mA}$

Specified over recommended temperature ($T_A = -40^\circ\text{C}$ to $+85^\circ\text{C}$, $4.5\text{V} \leq V_{CC} \leq 5.5\text{V}$), $I_F = 7.5\text{mA}$ unless otherwise specified. All typicals at $T_A = 25^\circ\text{C}$, $V_{CC} = 5.0\text{V}$.

Photocoupler 6N137-L series

5. SWITCHING SPECIFICATION

Parameter	Symbol	Min.	Typ.	Max.	Unit	Test Condition	Note
Propagation Delay Time to High Output Level	t_{PLH}	25	48	90	ns	$R_L = 350\Omega, C_L = 15pF$	3
Propagation Delay Time to Low Output Level	t_{PHL}	25	35	75	ns		4
Pulse Width Distortion	$ t_{PLH} - t_{PHL} $	—	13	—	ns		—
Propagation Delay Skew	t_{PSK}	—	—	40			—
Output Rise Time (10 to 90%)	t_r	—	21	—	ns		—
Output Fall Time (90 to 10%)	t_f	—	6.6	—	ns		—
Propagation Delay Time of Enable from V_{EH} to V_{EL}	t_{ELH}	—	27	—	ns	$R_L = 350\Omega, C_L = 15pF, V_{EL} = 0V, V_{EH} = 3V$	5
Propagation Delay Time of Enable from V_{EL} to V_{EH}	t_{EHL}	—	9	—	ns	$R_L = 350\Omega, C_L = 15pF, V_{EL} = 0V, V_{EH} = 3V$	6

Specified over recommended temperature ($T_A = -40^\circ\text{C}$ to $+85^\circ\text{C}$, $2.7V \leq V_{CC} \leq 3.6V$), $I_F = 7.5\text{mA}$ unless otherwise specified. All typicals at $T_A = 25^\circ\text{C}$, $V_{CC} = 3.3V$.

Parameter	Symbol	Min.	Typ.	Max.	Unit	Test Condition	Note	
Propagation Delay Time to High Output Level	t_{PLH}	25	40	75	ns	$T_A = 25^\circ\text{C}$ $R_L = 350\Omega, C_L = 15pF$	3	
		—	—	100				
Propagation Delay Time to Low Output Level	t_{PHL}	25	32	75	ns	$T_A = 25^\circ\text{C}$ $R_L = 350\Omega, C_L = 15pF$	4	
		—	—	100				
Pulse Width Distortion	$ t_{PLH} - t_{PHL} $	—	8	—	ns	$R_L = 350\Omega, C_L = 15pF$	—	
Propagation Delay Skew	t_{PSK}	—	—	40			—	
Output Rise Time (10 to 90%)	t_r	—	22	—	ns		—	
Output Fall Time (90 to 10%)	t_f	—	6.9	—	ns		—	
Propagation Delay Time of Enable from V_{EH} to V_{EL}	t_{ELH}	—	28	—	ns		$R_L = 350\Omega, C_L = 15pF, V_{EL} = 0V, V_{EH} = 3V$	5
Propagation Delay Time of Enable from V_{EL} to V_{EH}	t_{EHL}	—	12	—	ns		$R_L = 350\Omega, C_L = 15pF, V_{EL} = 0V, V_{EH} = 3V$	6

Specified over recommended temperature ($T_A = -40^\circ\text{C}$ to $+85^\circ\text{C}$, $4.5V \leq V_{CC} \leq 5.5V$), $I_F = 7.5\text{mA}$ unless otherwise specified. All typicals at $T_A = 25^\circ\text{C}$, $V_{CC} = 5.0V$.

Photocoupler 6N137-L series

Parameter	Symbol	Min.	Typ.	Max.	Unit	Test Condition	Note
Logic High Common Mode Transient Immunity	CM _H	10	15	—	kV/μs	V _{CC} = 3.3V V _{CM} = 1000V R _L = 350Ω I _F = 0mA T _A = 25°C	7
		10	15	—		V _{CC} = 5V V _{CM} = 1000V R _L = 350Ω I _F = 0mA T _A = 25°C	
Logic Low Common Mode Transient Immunity	CM _L	10	15	—	kV/μs	V _{CC} = 3.3V V _{CM} = 1000V R _L = 350Ω I _F = 10.0mA T _A = 25°C	8
		10	15	—		V _{CC} = 5V V _{CM} = 1000V R _L = 350Ω I _F = 10.0mA T _A = 25°C	

Photocoupler 6N137-L series

6. ISOLATION CHARACTERISTIC

Parameter	Symbol	Min.	Typ.	Max.	Unit	Test Condition	Note
Input-Output Insulation Leakage Current	I_{I-O}	—	—	1.0	μA	45% RH, $t = 5\text{s}$, $V_{I-O} = 3\text{kV DC}$, $T_A = 25^\circ\text{C}$	9
Withstand Insulation Test Voltage	V_{ISO}	5000	—	—	V_{RMS}	RH $\leq 50\%$, $t = 1\text{min}$, $T_A = 25^\circ\text{C}$	9, 10
Input-Output Resistance	R_{I-O}	—	10^{12}	—	Ω	$V_{I-O} = 500\text{V DC}$	9,
Input-Output Capacitance	C_{I-O}	—	1.0	—	p	$f = 1\text{MHz}$, $T_A = 25^\circ\text{C}$	9,

Specified over recommended temperature ($T_A = -40^\circ\text{C}$ to $+85^\circ\text{C}$) unless otherwise specified. Typical values applies to $T_A = 25^\circ\text{C}$

Notes

1. A 0.1 μF or bigger bypass capacitor for V_{CC} is needed as shown in Fig.1
2. Peaking driving circuit may be used to speed up the LED. The peak drive current of LED may go up to 50mA and maximum pulse width 50ns, as long as average current doesn't exceed 20mA.
3. t_{PLH} (propagation delay) is measured from the 3.75 mA point on the falling edge of the input pulse to the 1.5 V point on the rising edge of the output pulse.
4. t_{PHL} (propagation delay) is measured from the 3.75 mA point on the rising edge of the input pulse to the 1.5 V point on the falling edge of the output pulse.
5. The t_{ELH} enable propagation delay is measured from the 1.5 V point on the falling edge of the enable input pulse to the 1.5 V point on the rising edge of the output pulse.
6. The t_{EHL} enable propagation delay is measured from the 1.5 V point on the rising edge of the enable input pulse to the 1.5 V point on the falling edge of the output pulse.
7. CM_H is the maximum tolerable rate of rise of the common mode voltage to assure that the output will remain in a high logic state (i.e., $V_O > 2.0\text{ V}$).
8. CM_L is the maximum tolerable rate of fall of the common mode voltage to assure that the output will remain in a low logic state (i.e., $V_O < 0.8\text{ V}$).
9. Device is considered a two-terminal device: pins 1, 2, 3 and 4 shorted together, and pins 5, 6, 7 and 8 shorted together.
10. In accordance with UL1577, each optocoupler is proof tested by applying an insulation test voltage 5250Vrms for one second (leakage current less than 10 μA). This test is performed before the 100% production test for partial discharge

Photocoupler 6N137-L series

7. SWITCHING TIME TEST CIRCUIT

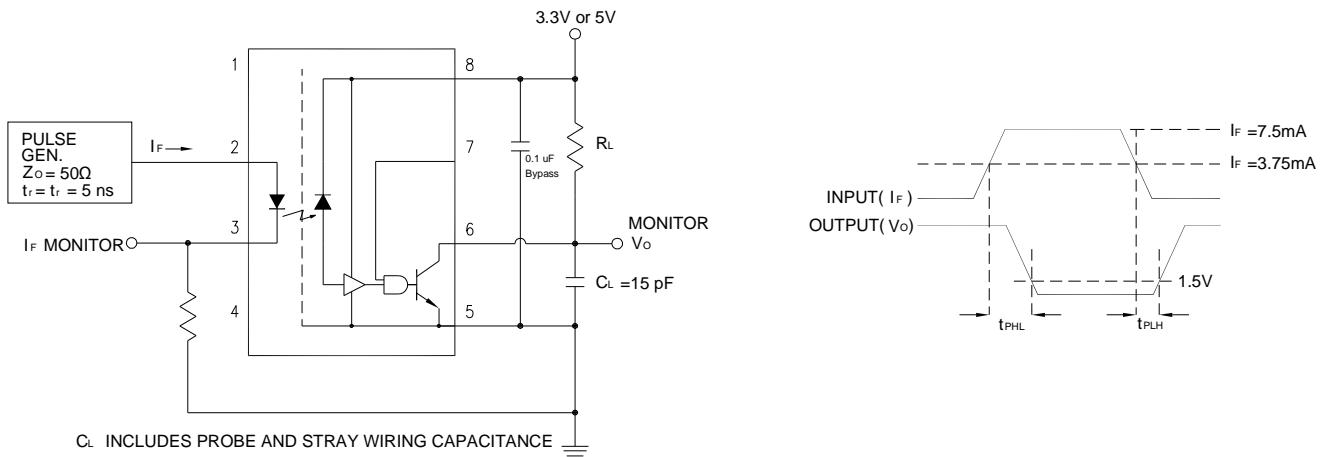

Figure 1: Test Circuit for t_{PHL} and t_{PLH}

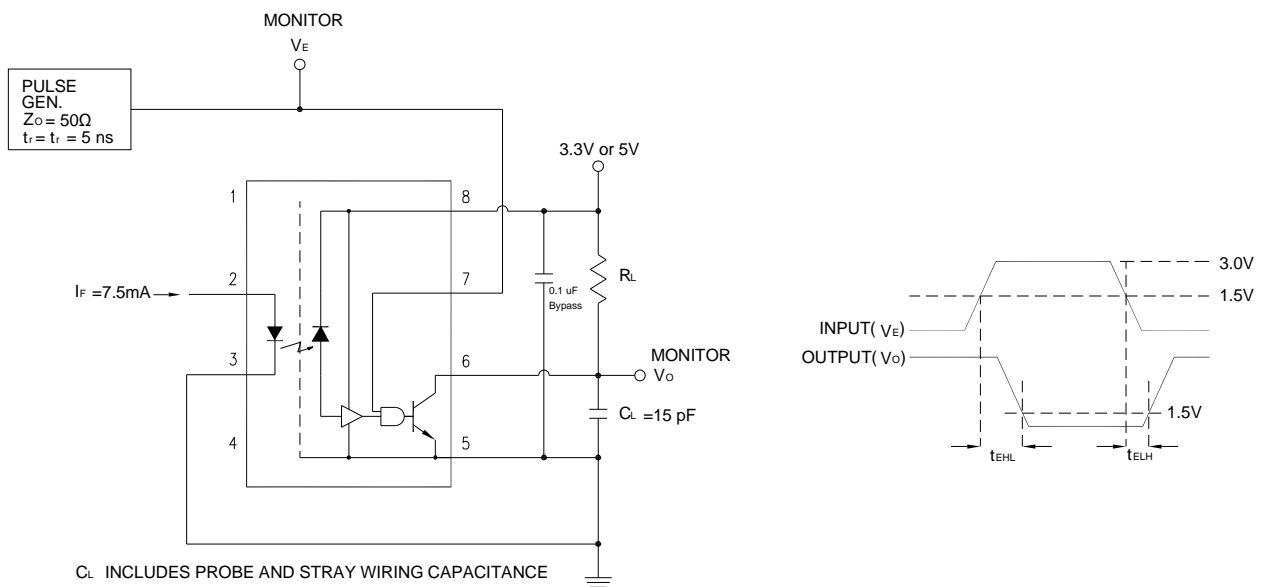

Figure 2: Single Channel Test Circuit for Common Mode Transient Immunity

Photocoupler 6N137-L series

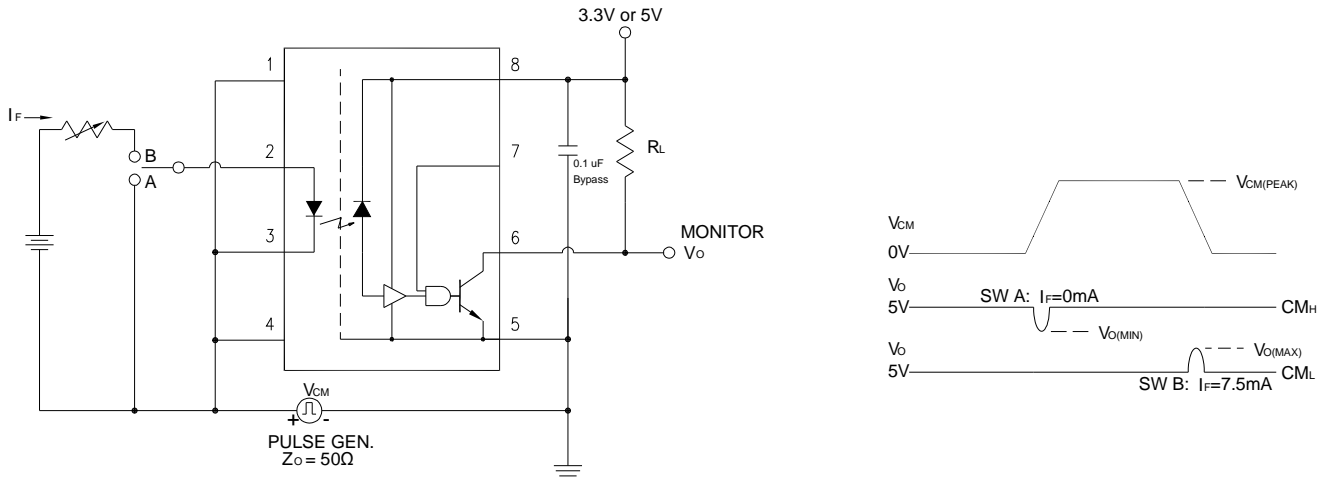

Figure 3: Single Channel Test Circuit for Common Mode Transient Immunity

Photocoupler 6N137-L series

8. CHARACTERISTIC CURVES

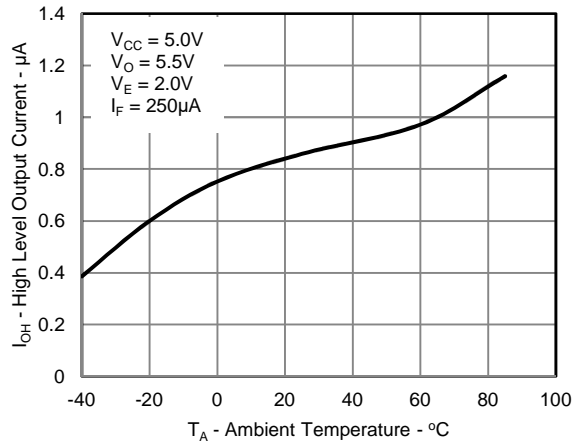
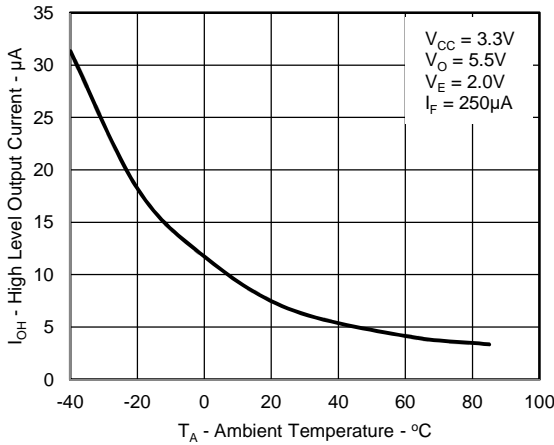

Figure 4: Typical High Level Output Current vs. Ambient Temperature

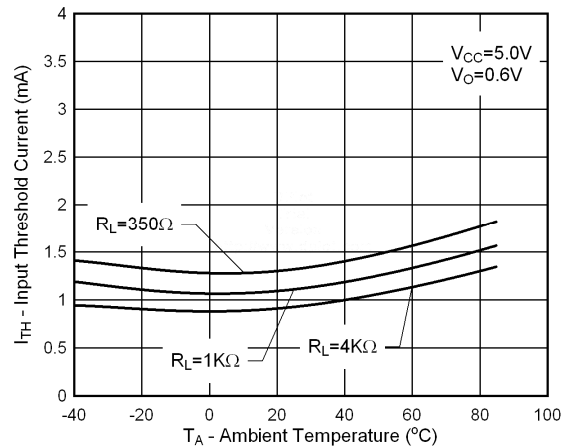
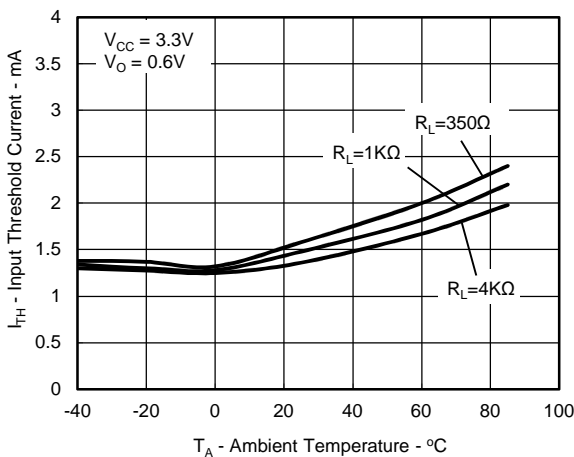

Figure 5: Typical Input Diode Threshold Current vs. Ambient Temperature

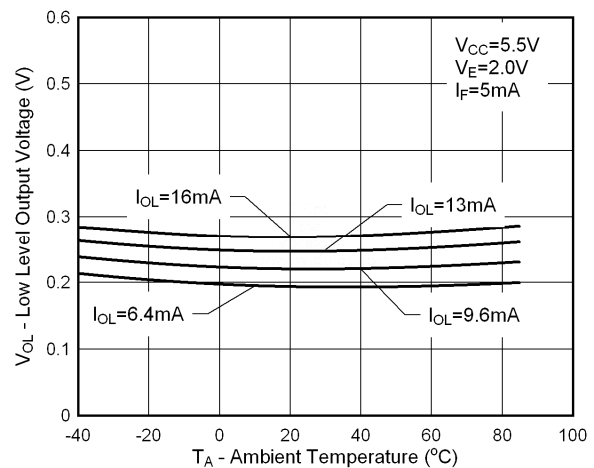
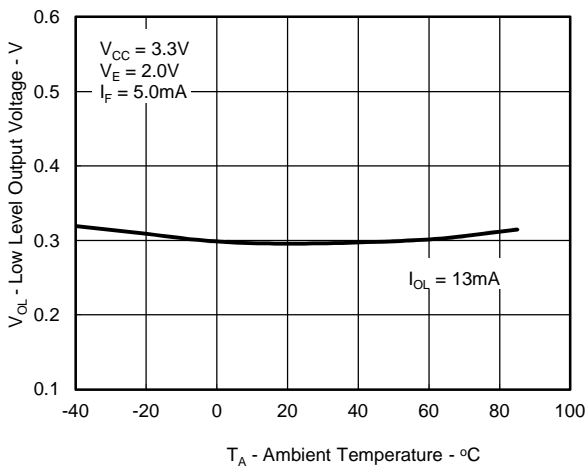

Figure 6: Typical Low Level Output Voltage vs. Ambient Temperature

Photocoupler 6N137-L series

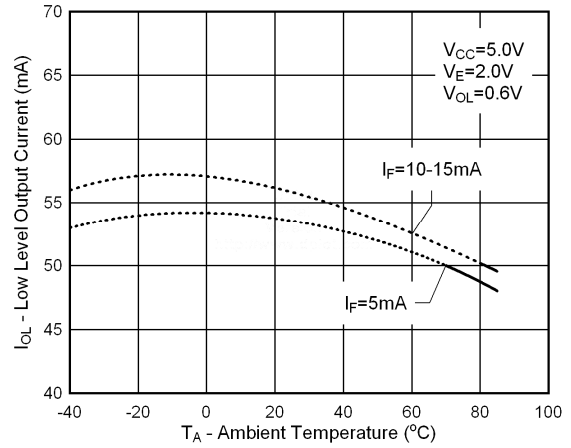
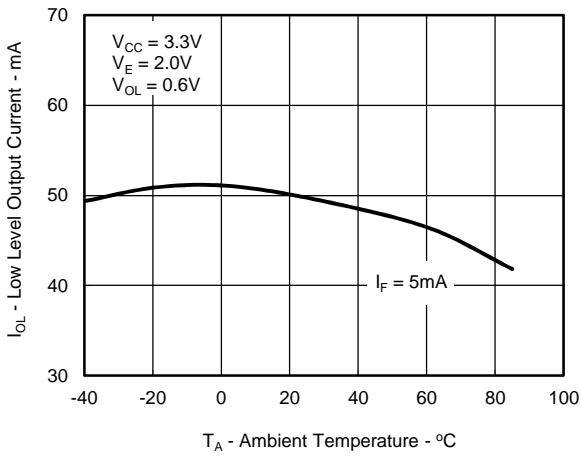

Figure 7: Typical Low Level Output Current vs. temperature

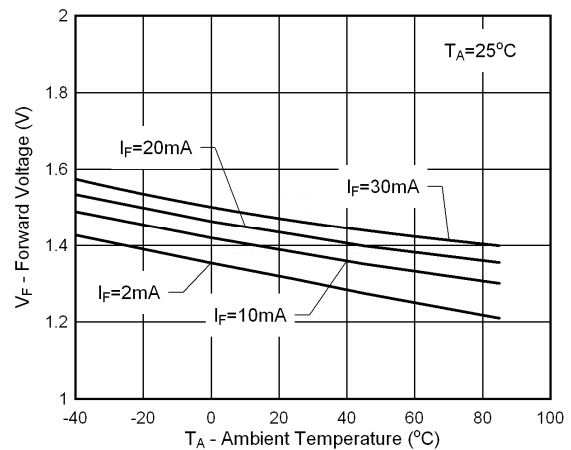
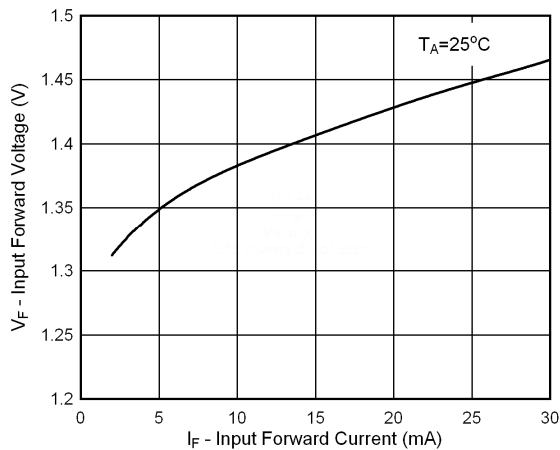

Figure 8: Typical Input Diode Forward Characteristic

Photocoupler 6N137-L series

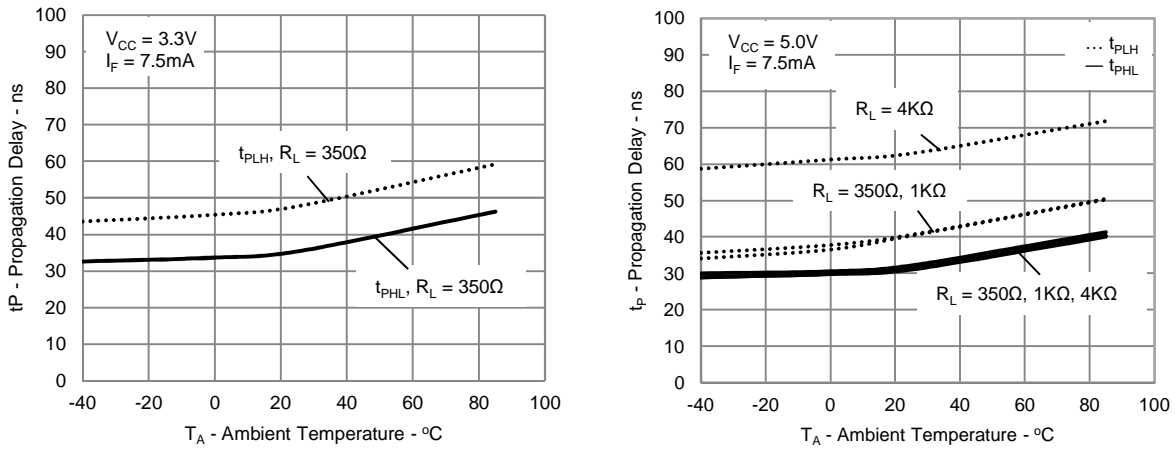

Figure 9: Typical Propagation Delay vs. Ambient Temperature

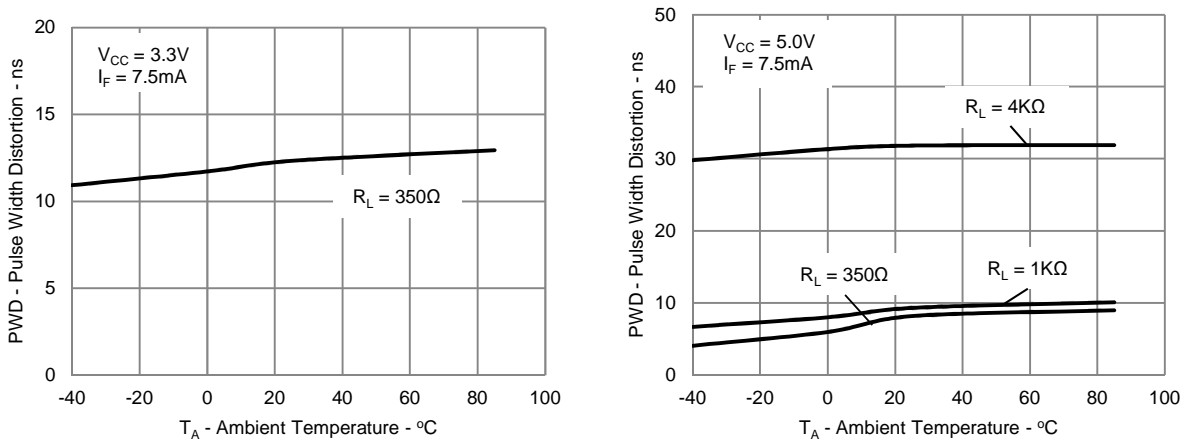

Figure 10: Typical Pulse Width Distortion vs. Ambient Temperature

Photocoupler 6N137-L series

9. TEMPERATURE PROFILE OF SOLDERING

9.1 IR Reflow soldering (JEDEC-STD-020C compliant)

One time soldering reflow is recommended within the condition of temperature and time profile shown below. Do not solder more than three times.

Profile item	Conditions
Preheat	
- Temperature Min (T_{Smin})	150°C
- Temperature Max (T_{Smax})	200°C
- Time (min to max) (ts)	90±30 sec
Soldering zone	
- Temperature (T_L)	217°C
- Time (t_L)	60 ~ 100 sec
Peak Temperature (T_P)	260°C
Ramp-up rate	3°C / sec max.
Ramp-down rate	3~6°C / sec

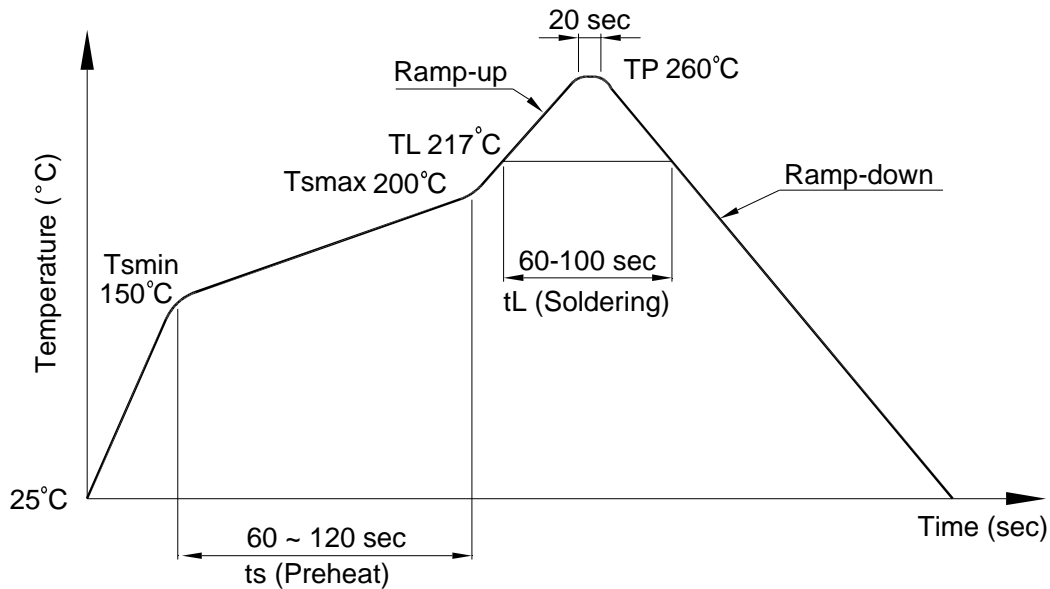

**Photocoupler
6N137-L series**

9.2 Wave soldering (JEDEC22A111 compliant)

One time soldering is recommended within the condition of temperature.

Temperature: $260+0/-5^{\circ}\text{C}$

Time: 10 sec.

Preheat temperature: 25 to 140°C

Preheat time: 30 to 80 sec.

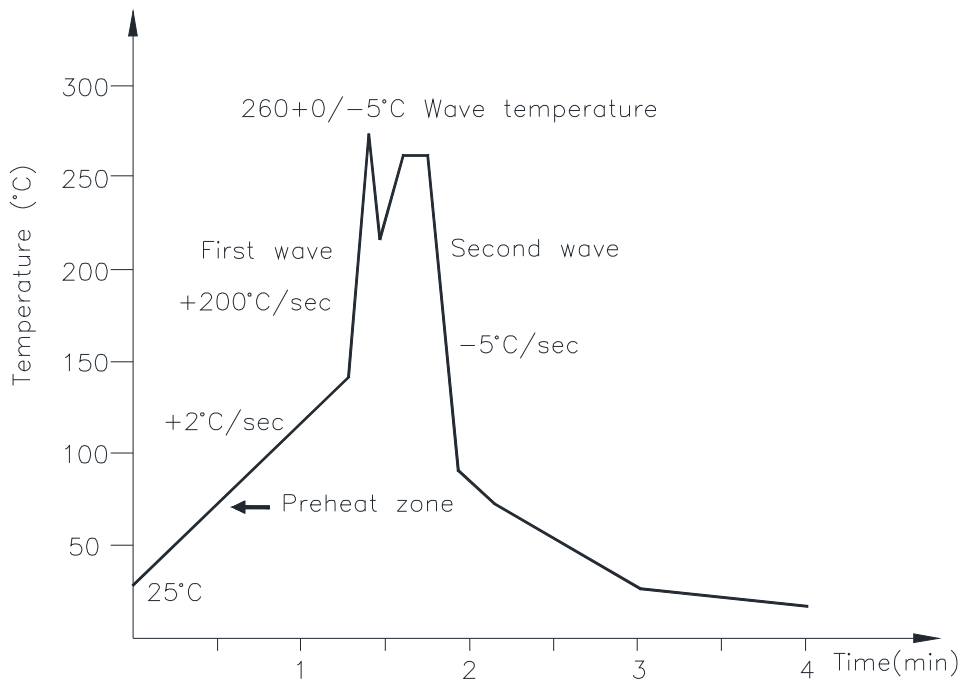

9.3 Hand soldering by soldering iron

Allow single lead soldering in every single process. One time soldering is recommended.

Temperature: $380+0/-5^{\circ}\text{C}$

Time: 3 sec max.

**Photocoupler
6N137-L series**

10. RECOMMENDED FOOT PRINT PATTERNS (MOUNT PAD)

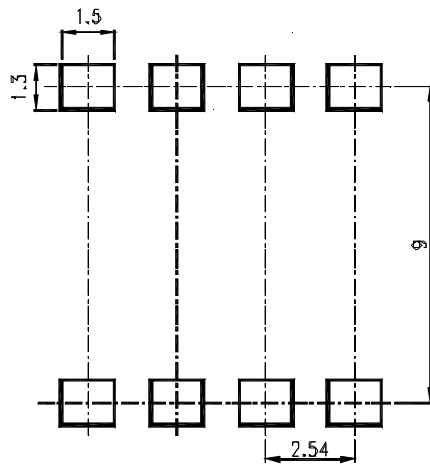

Note :

Dimensions in millimeters.

Photocoupler 6N137-L series

11. NAMING RULE

Part Number Options
6N13
6N137M
6N137S-TA
6N137S-TA1
6N137-V
6N137M-V
6N137STA-V
6N137TA1-V

Definition of Suffix	Remark
"6N137 "	LiteOn model name
"No Suffix"	Dual-in-Line package clearance distance 7 mm typical
"M"	Wide lead spacing package clearance distance 8 mm typical
"S"	Surface mounting package clearance distance 8 mm typical
"TA"	Pin 1 location at lower right of the tape
"TA1"	Pin 1 location at upper left of the tape
"V"	VDE approved option

12. NOTES

- LiteOn is continually improving the quality, reliability, function or design and LiteOn reserves the right to make changes without further notices.
- The products shown in this publication are designed for the general use in electronic applications such as office automation equipment, communications devices, audio/visual equipment, electrical application and instrumentation.
- For equipment/devices where high reliability or safety is required, such as space applications, nuclear power control equipment, medical equipment, etc, please contact our sales representatives.
- When requiring a device for any "specific" application, please contact our sales in advice.
- If there are any questions about the contents of this publication, please contact us at your convenience.
- The contents described herein are subject to change without prior notice.
- Immerse unit's body in solder paste is not recommended.

Mouser Electronics

Authorized Distributor

Click to View Pricing, Inventory, Delivery & Lifecycle Information:

[Lite-On:](#)

[6N137S-TA1](#) [6N137](#) [6N137M](#)