



Photointerrupter Product Data Sheet

LTH-301-05

Spec No.: DS-55-92-0002

Effective Date: 06/29/2000

Revision: -

LITE-ON DCC

RELEASE

BNS-OD-FC001/A4

FEATURES

- * NON-CONTACT SWITCHING.
- * FOR DIRECT PC BOARD OR DUAL-IN-LINE SOCKET MOUNTING.
- * FAST SWITCHING SPEED.

PACKAGE DIMENSIONS

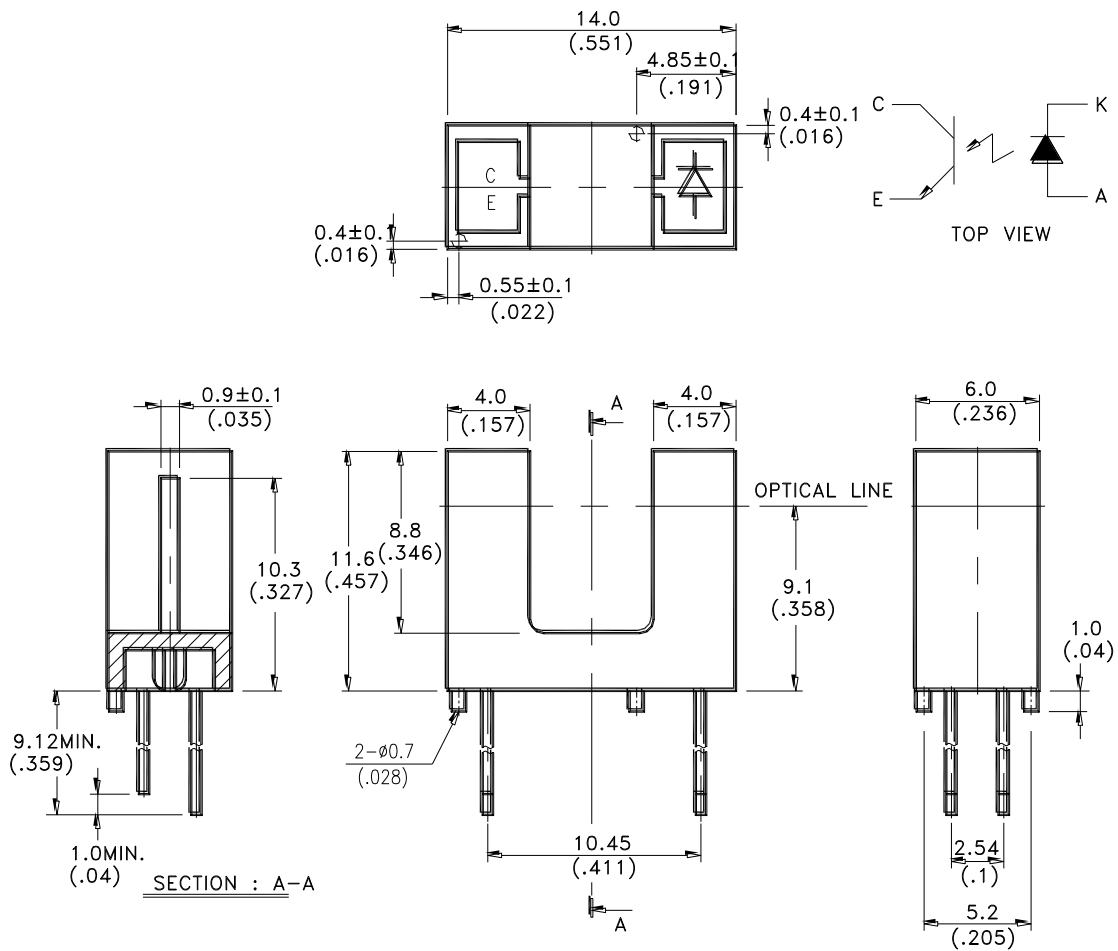

NOTES:

1. All dimensions are in millimeters (inches).
2. Tolerance is ± 0.25 mm(.010") unless otherwise noted.

ABSOLUTE MAXIMUM RATINGS AT T_A=25°C

PARAMETER	MAXIMUM RATING	UNIT
IR Diode Continuous Forward Current	60	mA
IR Diode Reverse Voltage	5	V
Transistor Collector Current	20	mA
Transistor Power Dissipation	75	mW
IR Diode Peak Forward Current (Pulse Wide = 10 μ S, 300 pps)	1	A
Diode Power Dissipation	100	mW
Phototransistor Collector-Emitter Voltage	30	V
Phototransistor Emitter-Collector Voltage	5	V
Operating Temperature Range	-25°C to + 85°C	
Storage Temperature Range	-40°C to + 100°C	
Lead Soldering Temperature [1.6mm(.063") From Case]	260°C for 5 Seconds	

ELECTRICAL OPTICAL CHARACTERISTICS AT TA=25°C

PARAMETER	SYMBOL	MIN.	TYP.	MAX.	UNIT	TEST CONDITION
INPUT LED						
Forward Voltage	VF		1.2	1.6	V	IF = 20mA
Reverse Current	IR			100	μA	VR=5V
OUTPUT PHOTOTRANSISTOR						
Collector-Emitter Breakdown Voltage	V(BR)CEO	30			V	IC=1mA
Emitter-Collector Breakdown Voltage	V(BR)ECO	5			V	IE=100 μA
Collector-Emitter Dark Current	ICEO			100	nA	VCE=10V
COUPLER						
Collector-Emitter Saturation Voltage	VCE(SAT)			0.4	V	IC=0.25mA IF=20mA
On State Collector Current	Ic(ON)	0.5			mA	VCE=5V IF=20mA
Response Time	Rise Time	tr	3	15	μS	VCE=5V, Ic=2mA RL=100Ω
	Fall Time	tf	4	20		

TYPICAL ELECTRICAL / OPTICAL CHARACTERISTICS CURVES

(25°C Ambient Temperature Unless Otherwise Noted)

Fig.1 Power Dissipation vs. Ambient Temperature

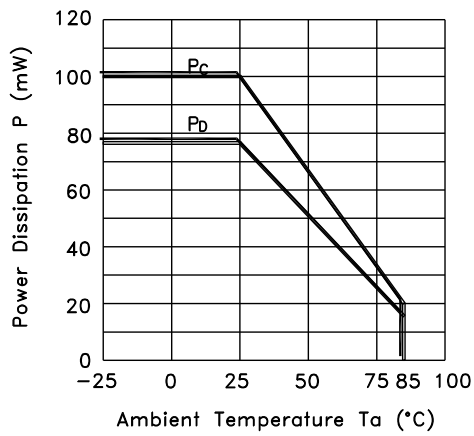

Fig.2 Forward Current vs. Forward Voltage

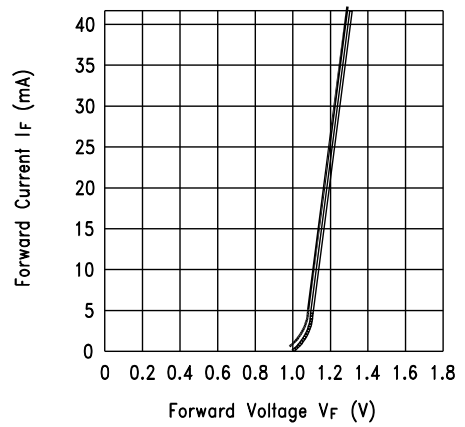

Fig.3 Collector Current vs. Collector-emitter Voltage

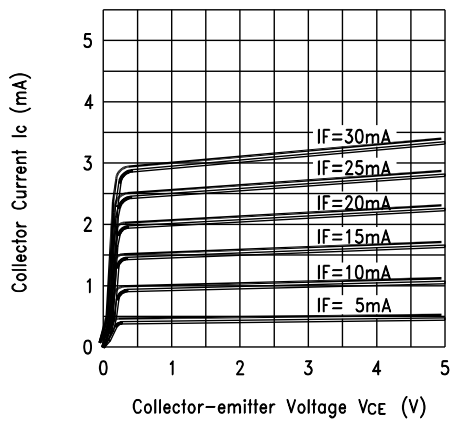
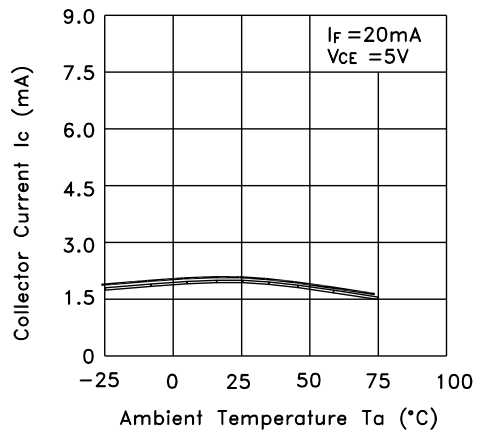

Fig.4 Collector Current vs. Ambient Temperature



TYPICAL ELECTRICAL / OPTICAL CHARACTERISTICS CURVES

(25°C Ambient Temperature Unless Otherwise Noted)

Fig.5 Collector-emitter Saturation Voltage vs. Ambient Temperature

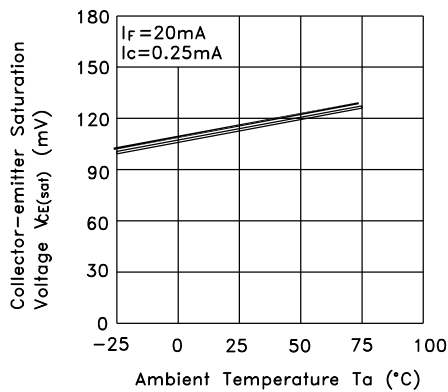
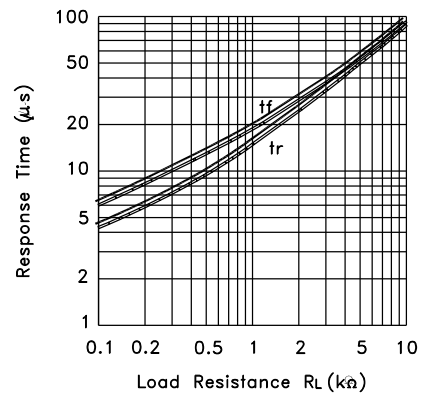
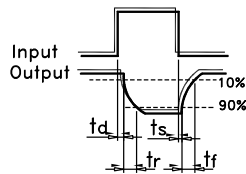
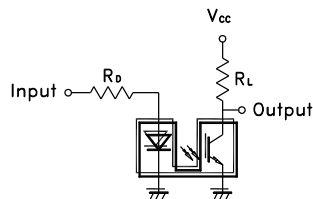

Fig.6 Response Time vs. Load Resistance



Test Circuit for Response Time



Mouser Electronics

Authorized Distributor

Click to View Pricing, Inventory, Delivery & Lifecycle Information:

[Lite-On:](#)

[LTH-301-05](#)