

Data Sheet

LL06ED-AExxL06



Xlamp XP-E



■ Features & Typical Applications

- High efficiency
- Available in 2 beam Patterns
- Optimized for uniform effects
- Lens without Housing
- Spot Lighting
- Architectural Lighting

■ Table of Contents

General Information & Product Nomenclature.....	P.2
Optical Specifications	P.3
Mechanical Specifications	P.4
Package Specifications	P.5

LL06ED-AExxL06

General Information

- Lens Material Optical Grade PMMA
- Operating Temperature range -40°C~+70°C(upper limit +80°C)
- Storage Temperature range -40°C~+70°C(upper limit +80°C)
 - * Average transmittance in visible spectrum 400nm~700nm>90%
- Usage and Maintenance:
 1. If necessary, clean lenses with mild soap, water and soft cloth.
 2. Never use any commercial cleaning solvents on lenses, like alcohol.
 3. Please handle or install lenses with wearing gloves, skin oils may damage lens or its optical characteristic.

Product Nomenclature

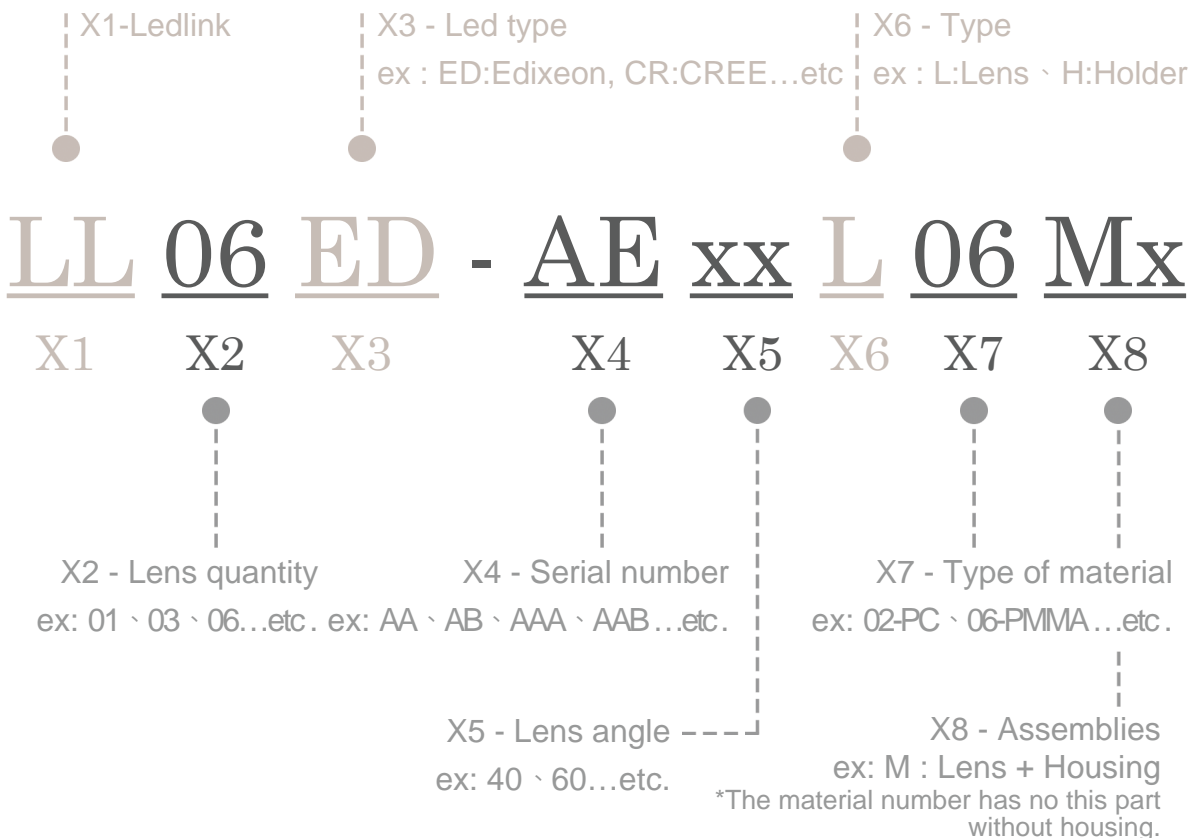



LL06ED-AE \times L06

Optical Specifications

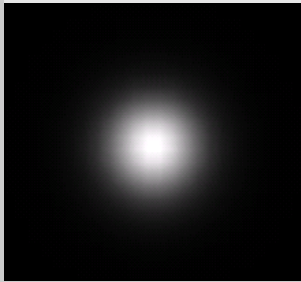
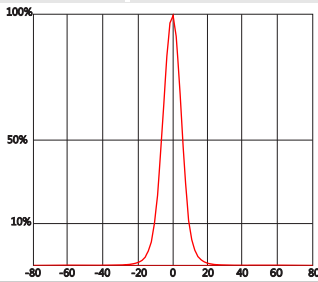
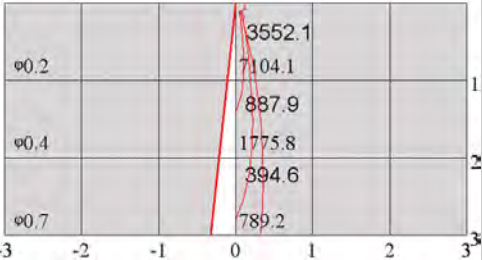

Note: (1) All the results of analysis are based on 0 degrees of elevation.
 (2) Tolerance: $\pm 10\%$.
 (3) Led Luminous Flux(lm): 100($\pm 5\%$).

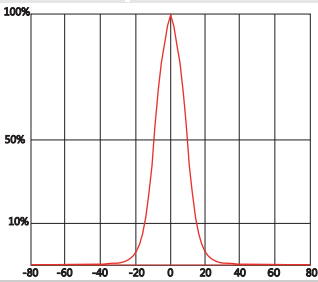
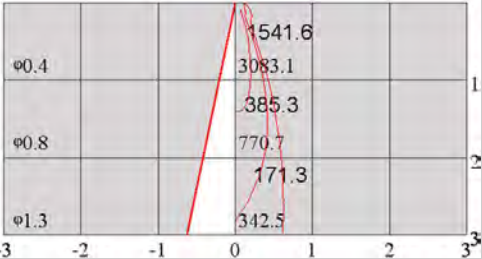
Part Number	FWHM	Field Angle*	cd / lm	IES File
LL06ED-AE25L06	14°	27°	11.8	Download
				
Beam Pattern	Light Distribution Curve		Illuminance Distribution	
Part Number	FWHM	Field Angle*	cd / lm	IES File
LL06ED-AE40L06	22°	39°	5.2	Download
				
Beam Pattern	Light Distribution Curve		Illuminance Distribution	

*Current series also come with AE08 and AE60. However, the performance with the LED is not satisfied hence it will not demonstrate here.

*The Field Angle is the angle between the two directions opposed to each other over the beam axis for which the luminous intensity is 10% that of the maximum luminous intensity.

*This testing result is obtained through testing the popular rank LED samples which provided by the original manufacturer. Hence, the testing results would be varied as the users choose same LED model but different rank.

LL06ED-AE \times L06

Mechanical Specification

1. Fixing method

 Glue

 Screw

 Tape

 Fixing-ring

 Frame

Note: (1) All dimensions are in mm.
 (2) All measurements are ± 0.15 mm unless otherwise indicated.

2. Lens dimensions

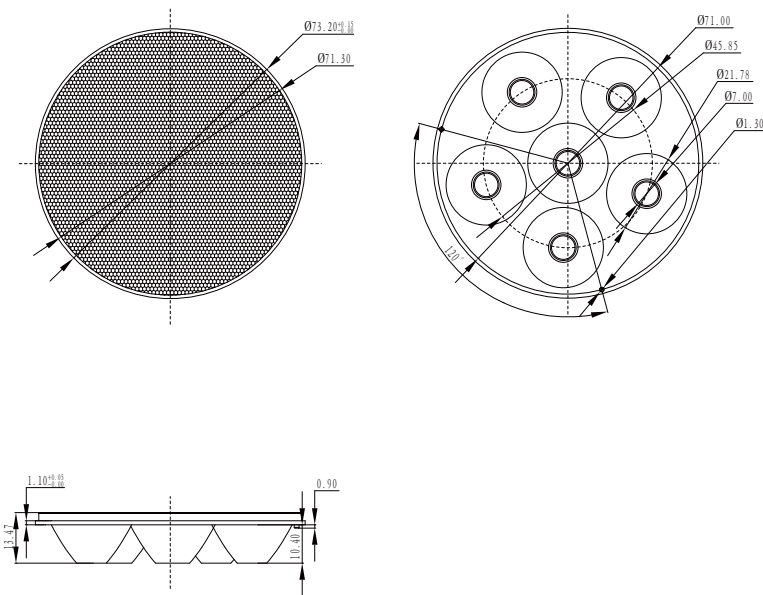

3. Lens + Leds + MCPCB assembly instruction

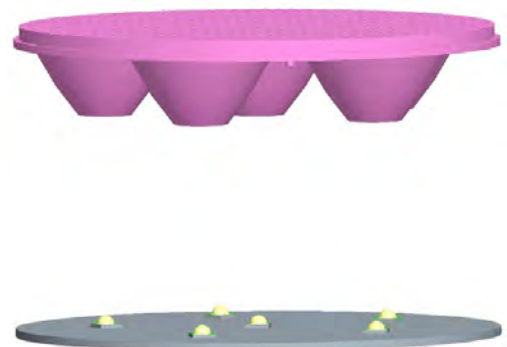

4. Lens assembly dimensions

5. View assembly lens with MCPCB:



LL06ED-AE \times L06 Package Specifications

Item	Quantity	Total	Size(L*W*H)	G.W
Inner box		16 pcs	38.2*36.2*1.85cm	30.8g
Outer box	160 pcs/Outer box	160 pcs	40*37*21 cm	

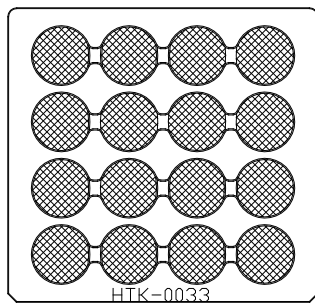

16 pcs/Inner box

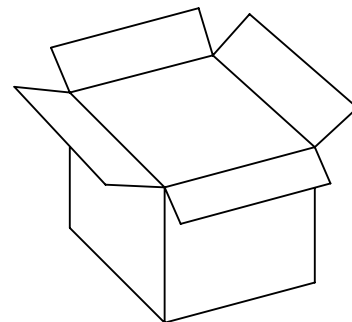
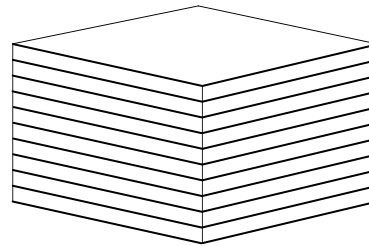

160 pcs/Outer box



Note:

Mouser Electronics

Authorized Distributor

Click to View Pricing, Inventory, Delivery & Lifecycle Information:

[LedLink Optics:](#)

[LL06ED-AE25L06](#)