

# Reflexus Penta-band SMD Antenna

Part No. A10315

gigaNOVA®

Product Specification

## 1 Features

- GSM/UMTS antenna supporting up to 5 frequency bands
- Complementary antenna technology provides resistance to de-tuning
- High efficiency
- Easy to integrate
- Intended for SMD mounting
- Supplied in tape on reel

Reflexus supports the following communication standards:

GSM/GPRS/EDGE	CDMA2000 1xRTT/EV-DO/EV-DV	UMTS WCDMA/HSPA	Other Standards
GSM850 (E)GSM900 GSM1800 (DCS) GSM1900 (PCS)	Band Classes: 1,2,3,4,6,8,9,12,14,15	Bands I – VI Bands VIII – X	Korean PCS DECT TD-SCDMA AWS

## 2 Description

Reflexus uses a ground plane in order to radiate efficiently, but this ground plane must not extend underneath the antenna itself.

The antenna uses a matching circuit to achieve optimized results for the specific frequency bands that are required. This product specification shows the performance of the antenna when optimized to cover a typical penta-band reception: GSM850/900/1800/1900 and WCDMA.

## 3 Applications

- Mobile handsets
- Femto / Pico base stations
- Tracker devices
- Machine to machine communication
- Remote monitoring



## 4 Part number

Reflexus: A10315



## 5 General data

Product name	Reflexus GSM SMD
Part Number	A10315
Frequency	824 – 960 MHz 1710 – 2170 MHz
Polarization	Linear
Operating temperature	-40 °C to +85 °C
Impedance with matching	50 Ω
Weight	2.5 g
Antenna type	SMD
Dimensions	40 x 10 x 3.2 [mm]

## 6 Electrical characteristics

	Typical performance	Conditions
Peak gain	2dBi @ 876 MHz 3.7dBi @ 1917 MHz	All data measured on Antenna's reference board, part number <b>A10315-U1M</b>  Data given for the 824MHz-960MHz and 1710MHz-2170MHz frequency ranges
Average gain (Linear)	-1.3dBi 824-960 MHz  -1.5dBi 1710-2170 MHz	
Average efficiency 824-960 MHz 1710-217 MHz	70% >60@	
Maximum Return Loss	-8 dB	
Maximum VSWR	2.3:1	

# 7 Electrical performance

## 7-1 Return Loss

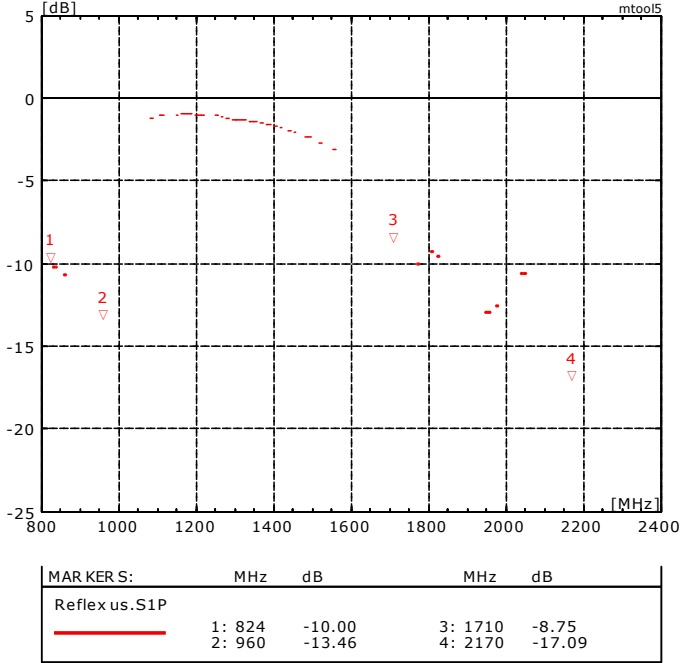

## 7-2 VSWR

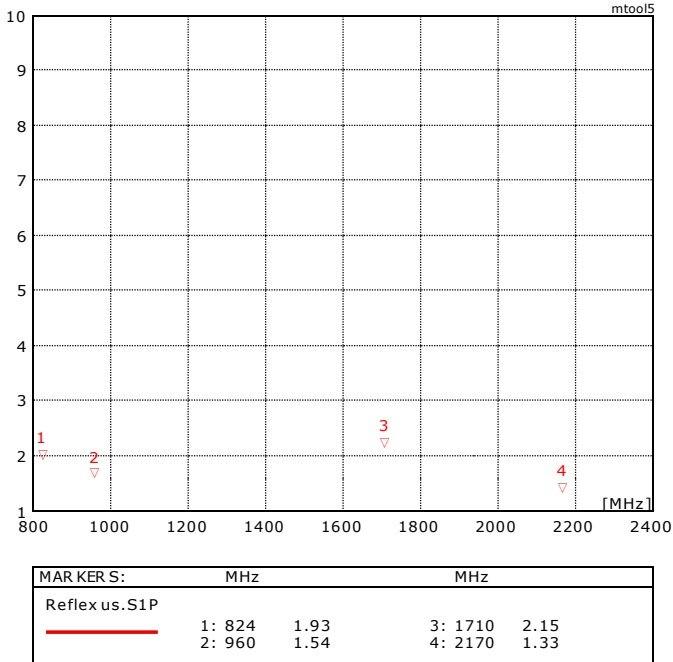

7-3 Antenna patterns 824-960 MHz

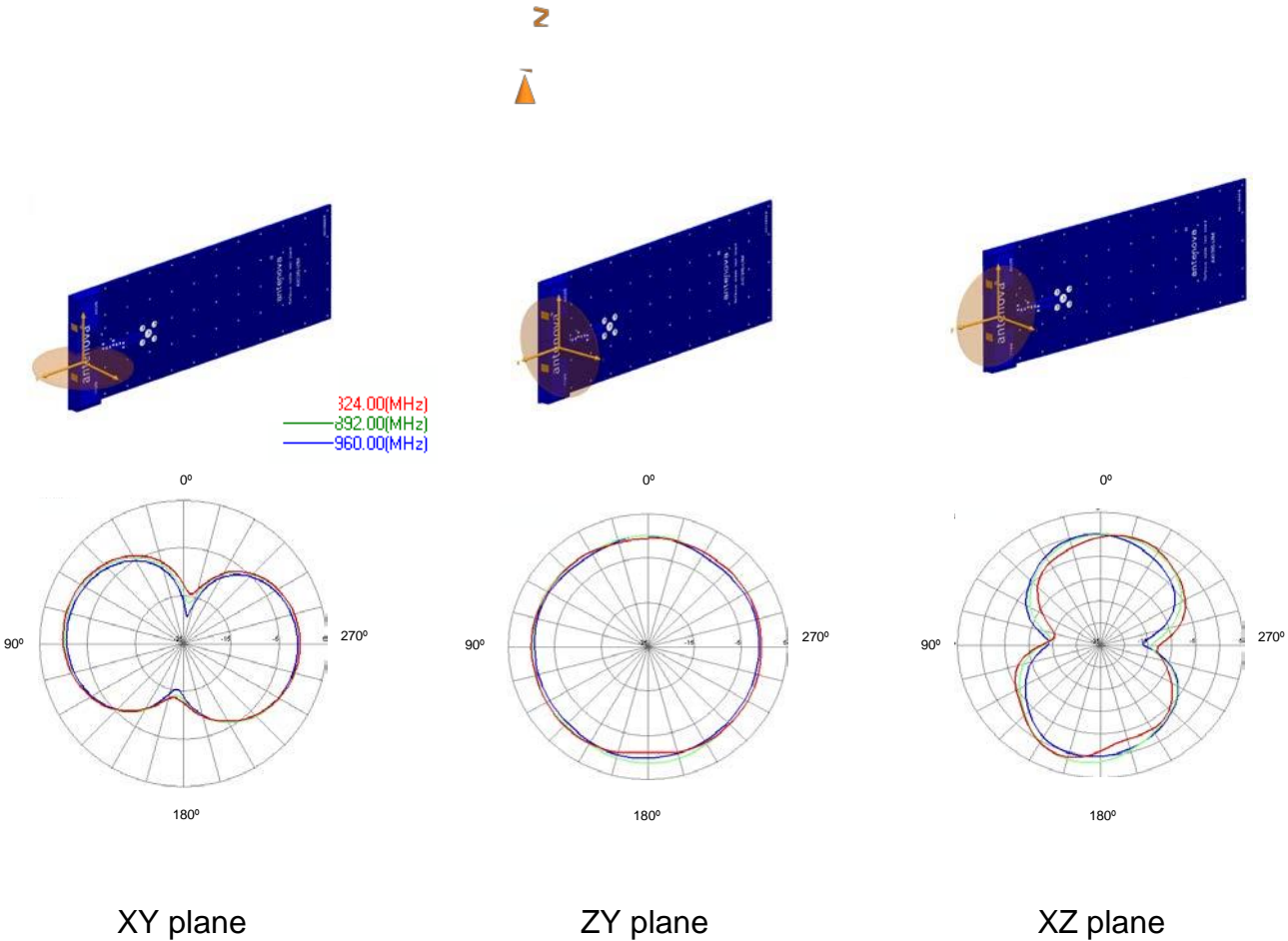
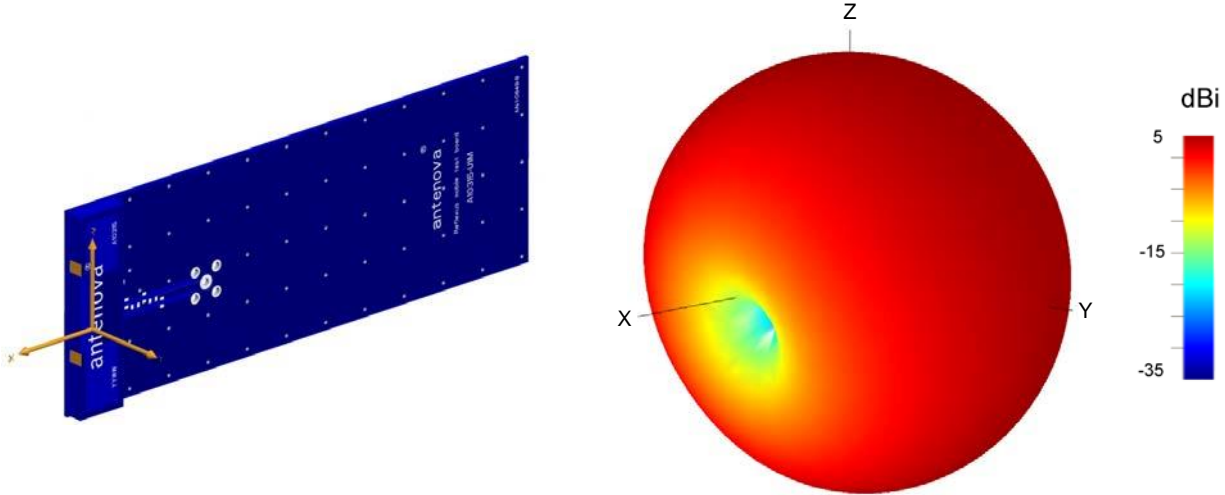

Patterns show combined polarisations measured on reference board A10315-U1M. 3D Pattern measured at 890MHz

7-4 Antenna patterns 1710 – 2170 MHz

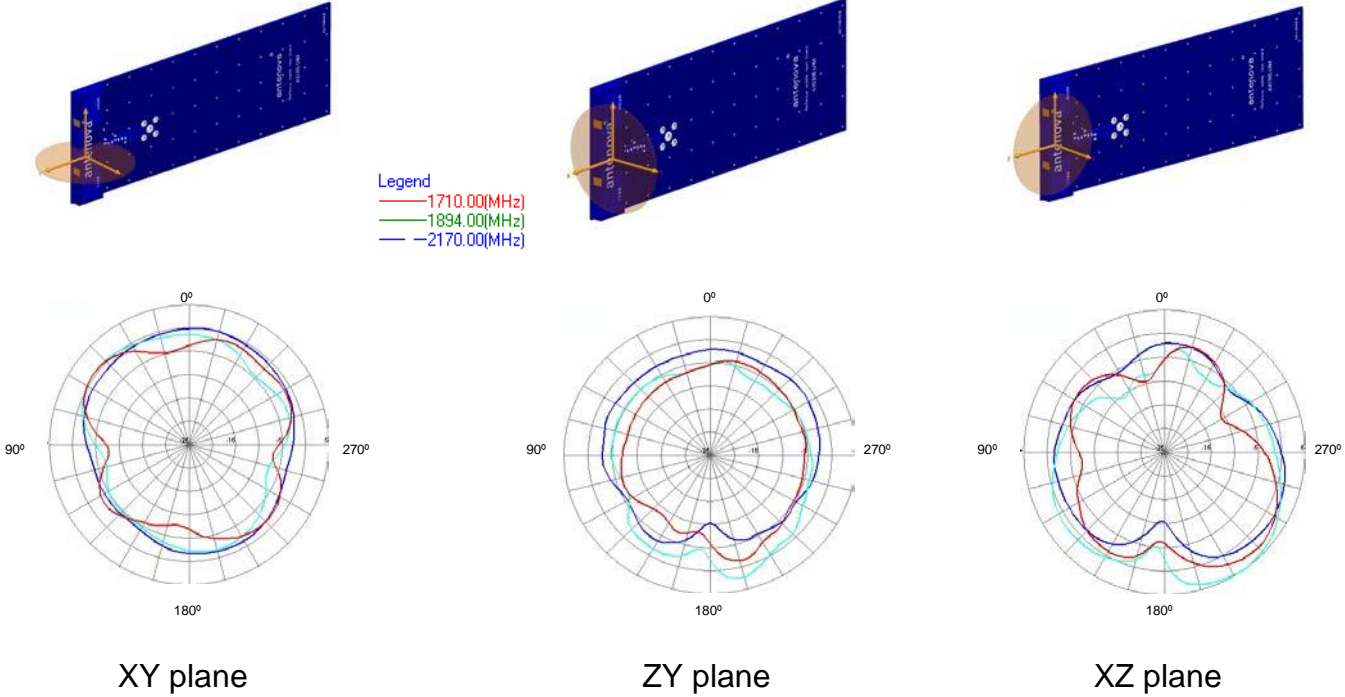
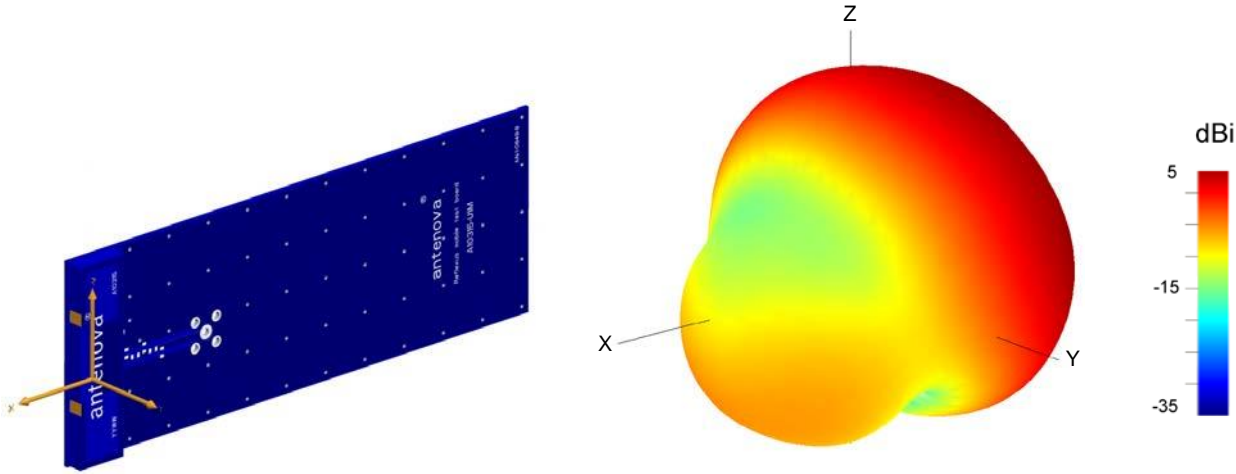

Patterns show combined polarisations measured on reference board A10315-U1M. 3D Pattern measured at 1894MHz

### 8 Antenna efficiency

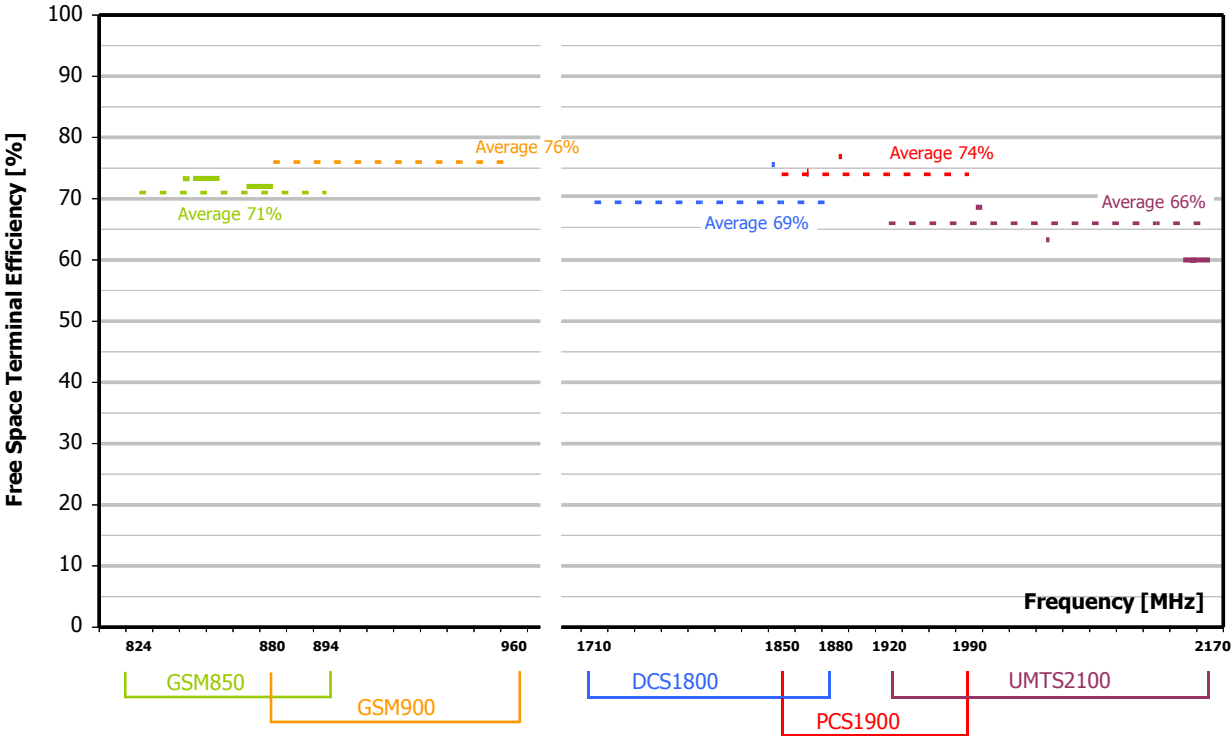

### 9 Antenna dimensions

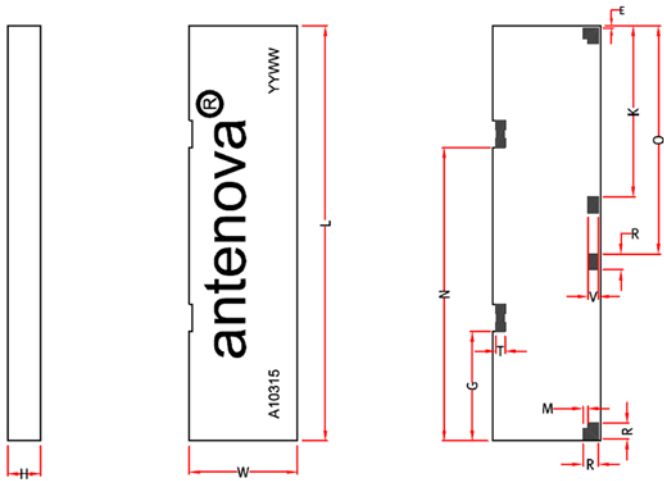

L	W	H	E	N	T	G	R	M	V	O	K
Length	Width	Height									
40.0 +/- 0.2	10.4 +/- 0.2	3.2 +/- 0.2	0.2 +/- 0.15	28.28 +/- 0.15	0.9 +/- 0.15	10.56 +/- 0.15	1.5 +/- 0.15	0.2 +/- 0.15	1.0 +/- 0.15	22 +/- 0.15	16.5 +/- 0.15

Dimensions in mm

**10 Antenna footprint**

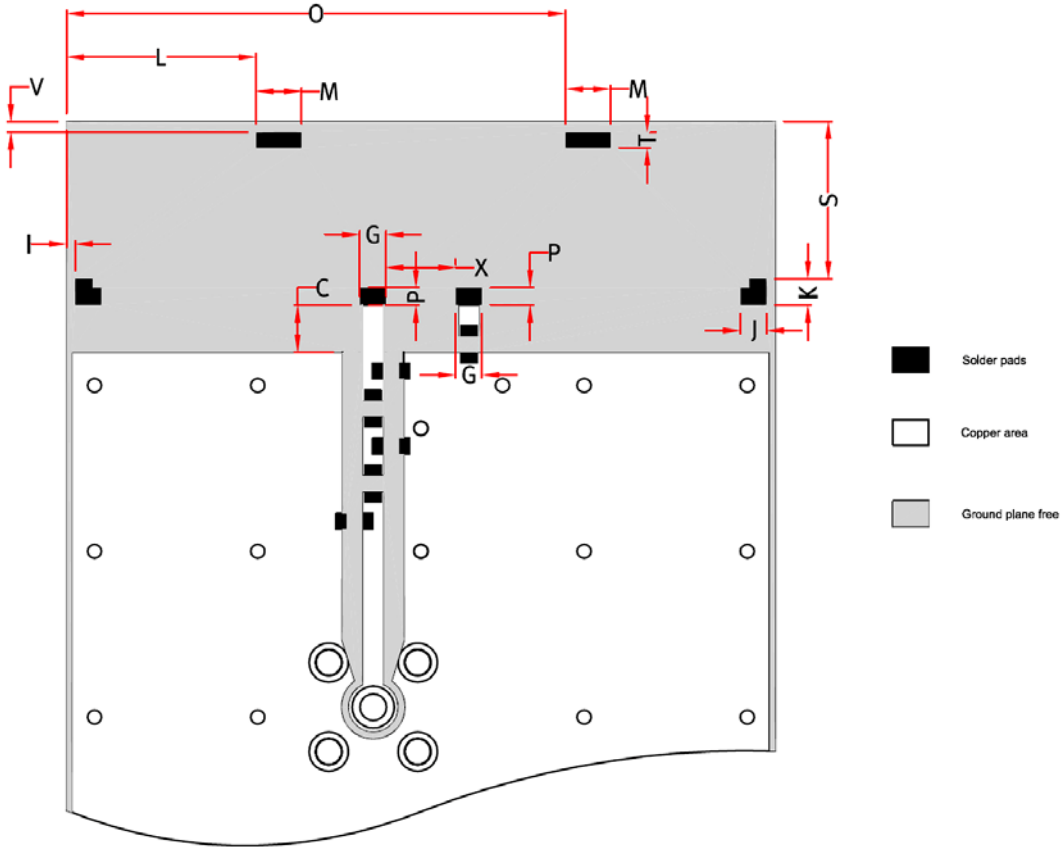

**Reflexus GSM (Part No: A10315)**

CAD files of the antenna footprint are available to download from [www.antenova-m2m.com](http://www.antenova-m2m.com).

X	P	C	G	I	J	K	S	M	O	V	T	L
4.0 +/-0.1	1.0 +/-0.1	2.7 +/-0.1	1.5 +/-0.1	0.5 +/-0.1	1.5 +/-0.1	1.5 +/- 0.1	9.0 +/-0.1	2.6 +/-0.1	28.58 +/-0.1	0.6 +/- 0.1	0.9 +/- 0.1	10.86 +/- 0.1

## 11 Electrical interface

### 11-1 Transmission lines

The antenna should be connected using an RF transmission line.

All transmission lines should be designed to have a characteristic impedance of 50  $\Omega$

The length of the transmission lines should be kept to a minimum. Any other parts of the RF system like transceivers, power amplifiers, etc, should also be designed to have an impedance of 50  $\Omega$

Once the material for the PCB has been chosen (PCB thickness and dielectric constant), a co-planar transmission line can easily be designed using any of the commercial software packages for transmission line design. For the chosen PCB thickness, copper thickness and substrate dielectric constant, the program will calculate the appropriate transmission line width and gaps on either side of the track so the characteristic impedance of the co-planar transmission line is 50  $\Omega$  .



## 11-2 Matching circuit

The antenna requires a matching circuit that must be optimized for each customer's product. The matching circuit will require up to five components depending on the impedance of the antenna when situated in the device, and pads have been designed for 0603 components for best results. In addition to the matching circuit, a separate DC blocking capacitor will also be required between the radio and the antenna matching circuit.

The following pad layout should be designed into the device so the correct circuit can be installed:

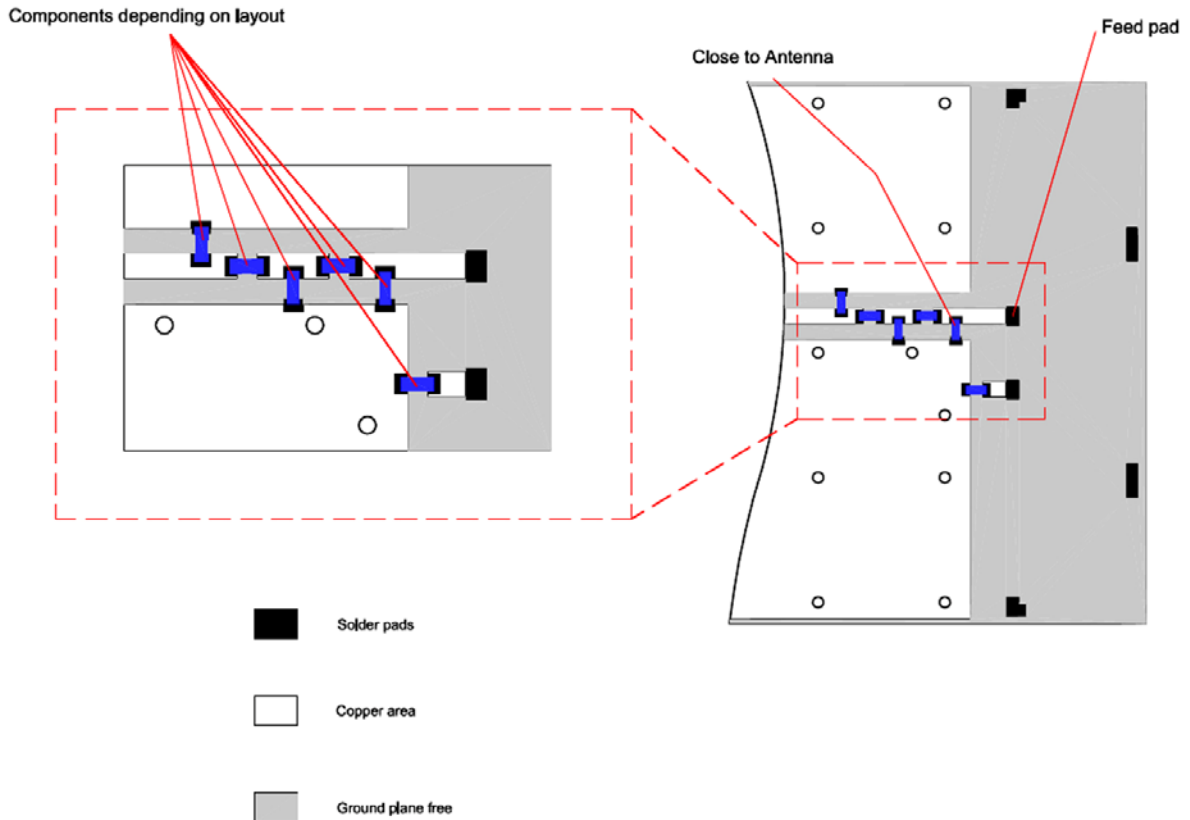

**Note:** The component values for the matching circuit will vary depending on the size of the PCB and surrounding components. The impedance of the antenna should be measured before selecting suitable matching components. Antenova M2M offers a matching service on request. Contact [sales@antenova-m2m.com](mailto:sales@antenova-m2m.com) for further information.

### 11-3 Antenna placement

Reflexus should be fitted to the device so that power from the antenna can radiate into free space. Antenova M2M strongly recommends placing the antenna near the edge of the board. Maximum antenna performance is achieved by placing the antenna close to the corner of the PCB with few components or metal objects nearby. Ground can be placed at the side of the antenna, but the remaining space around the antenna, including directly above and below should be free from components or conducting objects. The placements shown here are for guidance only, as the actual performance differences will depend on each individual device.

Antenova offers a full range of development support to ensure efficient implementation of the antenna into the specific design. To overcome RF design issues, matching circuits, transmission lines, layout and other components, please contact Antenova M2M ([sales@antenova-m2m.com](mailto:sales@antenova-m2m.com)) for design and placement recommendations.

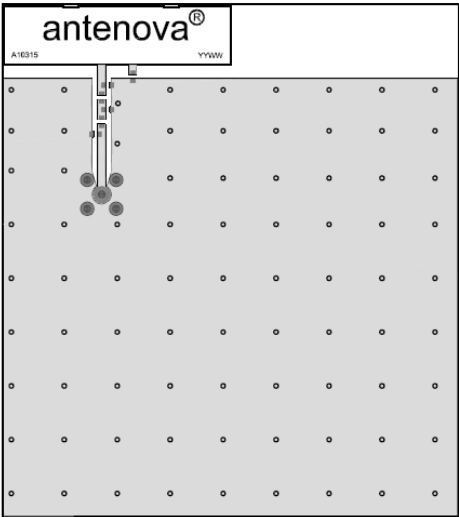

Antenna mounted Left Hand Side (LHS)

Best Performance

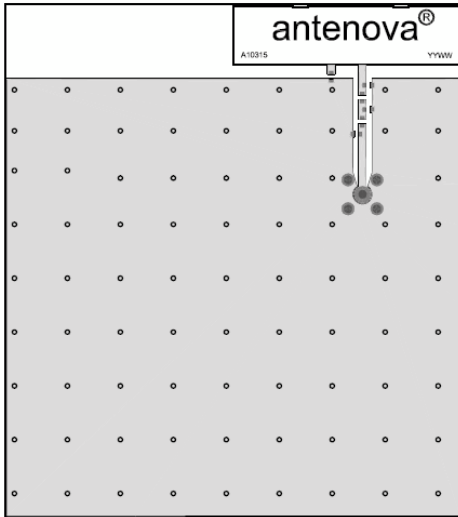

Antenna mounted Right Hand Side (RHS)

Best Performance

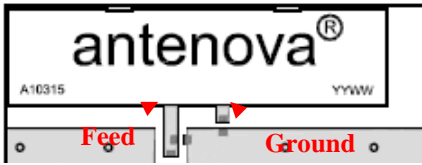

Antenna Placement and relative feed and ground positions

### 11-4 Reference boards

The reference board has been designed for evaluation purposes of Reflexus GSM antenna and it includes a SMA female connector. The reference board is available with Reflexus tuned to cover 5 bands: GSM850/900/1800/1900 and WCDMA, Part number: A10315-U1M

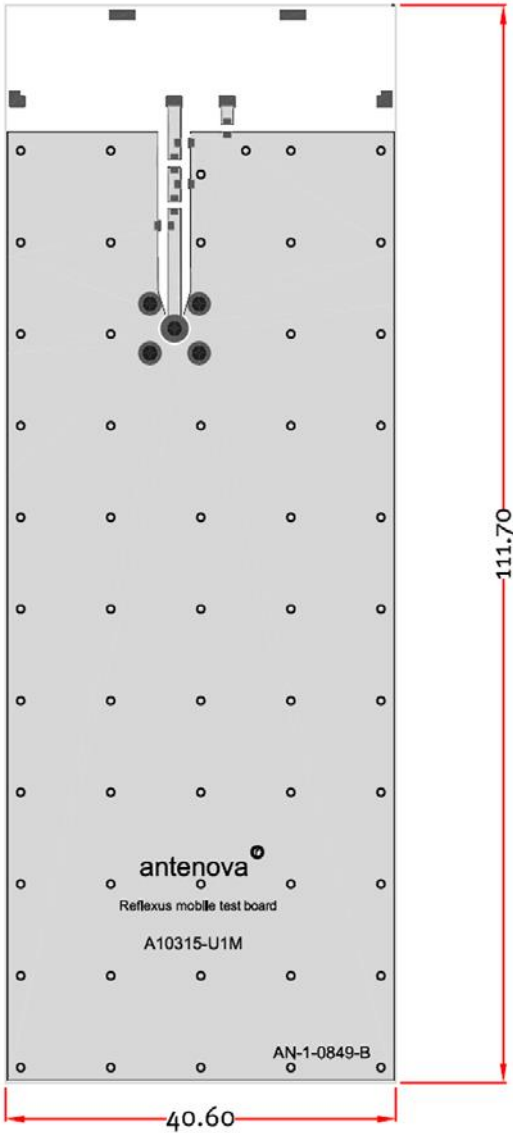

Dimensions in mm

Note: Other size reference boards are available for typical applications. Contact [sales@antenna-m2m.com](mailto:sales@antenna-m2m.com) for further information or to order a reference board.

## 12 Soldering

This antenna is suitable for lead free soldering.

The reflow profile should be adjusted to suit the PCBA, oven and solder paste, while observing the following conditions:

- The maximum temperature should not exceed 240 °C
- However for lead free soldering, a maximum temperature of 255 °C for no more than 20 seconds is permitted.
- The antenna should not be exposed to temperatures exceeding 120 °C more than 3 times during the soldering process.

## 13 Hazardous material regulation conformance

The antenna has been tested to conform to RoHS requirements. A certificate of conformance is available from Antenova M2M's website.

## 14 Packaging

### 14-1 Optimal storage conditions for packaged reels

<b>Temperature</b>	-10°C to 40°C
<b>Humidity</b>	Less than 75% RH
<b>Shelf Life</b>	18 Months
<b>Storage place</b>	Away from corrosive gas and direct sunlight
<b>Packaging</b>	Reels should be stored in unopened sealed manufacturer's plastic packaging.

**Note: Storage of open reels of antennas is not recommended due to possible oxidization of pads on antennas. If short term storage is necessary, then it is highly recommended that the bag containing the antenna reel is re-sealed and stored in like storage conditions as in above table.**

### 14-2 Tape characteristics

### Reflexus

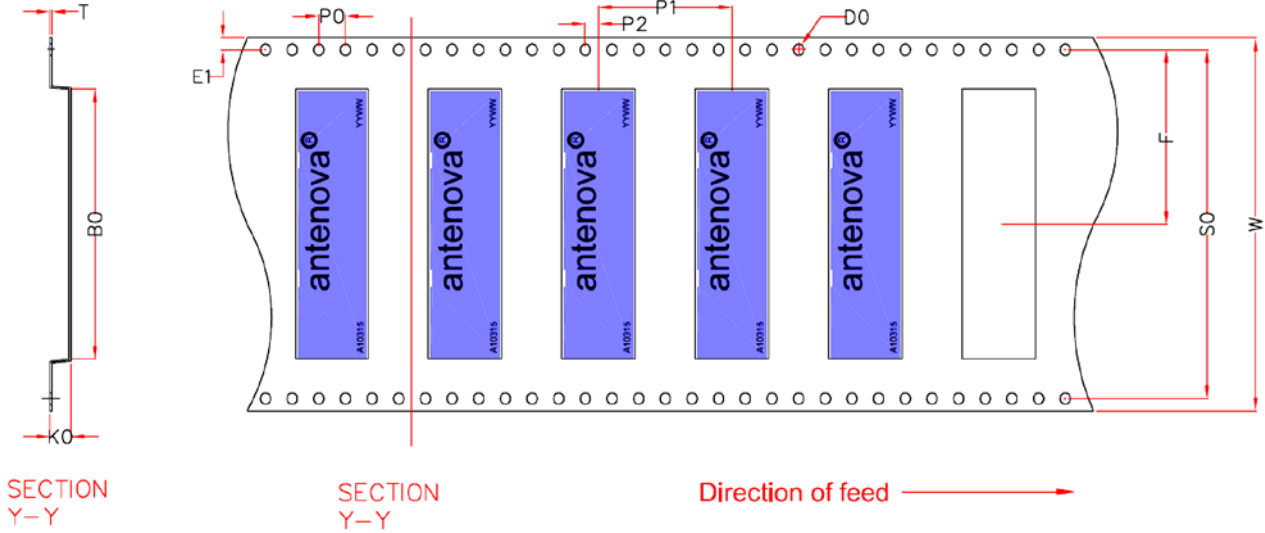

W	F	E1	P0	P1	P2	A0	B0	K0	SO	T	D0
56 ± 0.2	26.2 ± 0.1	1.75 ± 0.1	4 ± 0.1	20 ± 0.1	2 ± 0.1	9.3 ± 0.1	40.6 ± 0.1	3.2 ± 0.1	52.4 ± 0.1	0.3 ± 0.05	Min 1.5 +/- 0.1

Dimensions in mm

Quantity	Leading Space	Trailing Space
1000 pcs / reel	50 blank antenna holders	50 blank antenna holders

### 14-3 Reel dimensions

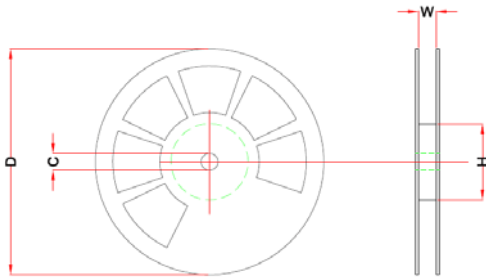

Width	Reel Diameter	Hub Diameter	Shaft Diameter
57.5 mm	330 ± 2.0 mm	80 mm	13 ± 0.5 mm

### 14-4 Box dimensions

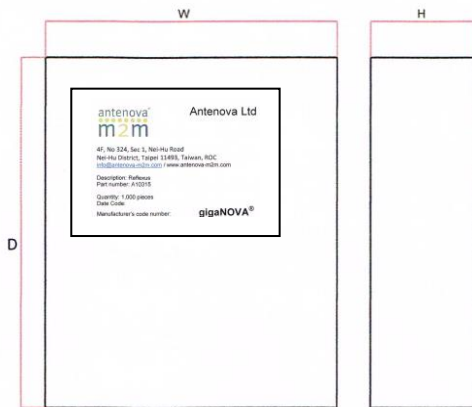

Width (W)	Breadth (B)	Thickness (H)
195 mm	195 mm	37 mm

### 14-5 Bag properties

Reels are supplied in protective plastic packaging

### 14-6 Reel label information

#### Reflexus



Dimensions in mm



**[www.antenova-m2m.com](http://www.antenova-m2m.com)**

**Corporate Headquarters**

Antenova Ltd.  
2<sup>nd</sup> Floor, Titan Court  
3 Bishop Square  
Hatfield  
AL10 9NA

**North America Headquarters**

Antenova Ltd.  
100 Brush Creek Road, Suite 103  
Santa Rosa  
California, 95404, USA

**Asia Headquarters**

Antenova Asia Ltd.  
4F, No. 324, Sec. 1, Nei-Hu Road  
Nei-Hu District  
Taipei 11493  
Taiwan, ROC

**Tel:** +44 1223 810600

**Email:** [sales@antenova-m2m.com](mailto:sales@antenova-m2m.com)

**Tel:** +1 707 890 5202

**Email:** [sales@antenova-m2m.com](mailto:sales@antenova-m2m.com)

**Tel:** +886 (0) 2 8797 8630

**Fax:** +886 (0) 2 8797 6890

**Email:** [sales@antenova-m2m.com](mailto:sales@antenova-m2m.com)

**Copyright® Antenova Ltd.** All Rights Reserved. Antenova®, Antenova M2M®, gigaNOVA®, the Antenova product family names, and the Antenova and Antenova M2M logos are trademarks and/or registered trademarks of Antenova Ltd. Any other names and/or trademarks belong to their respective companies.

The materials provided herein are believed to be reliable and correct at the time of print. Antenova does not warrant the accuracy or completeness of the information, text, graphics or other items contained within these information. Antenova further assumes no responsibility for the use of this information, and all such information shall be entirely at the user's risk.



Certificate No: 4598

**Antennas for Wireless M2M Applications**

# Mouser Electronics

Authorized Distributor

Click to View Pricing, Inventory, Delivery & Lifecycle Information:

[Antenova:](#)

[A10315](#)