

# Inversa LTE Antenna

Part No. SR4L034-L / SR4L034-R

lamiiANT<sup>®</sup>

Product Specification

## 1. Features

- Antenna for 4G and 3G applications
- LTE, GSM, CDMA, DCS, PCS, WCDMA, UMTS, HSPDA, GPRS, EDGE, IMT
- Frequencies: 698-960MHz; 1710-2170MHz; 2300-2400MHz; 2500-2690MHz
- Corner placement for ergonomic design-in
- SMD mounted device
- Supplied on Tape and Reel
- Automotive temperature rating.
- Compact 28 x 8 x 3.3 (mm)
- Ideal for MIMO systems

## 2. Description

Inversa is intended for use with 4G/3G applications. As a single antenna or in MIMO systems, this antenna was specifically designed for coexistence and minimal space requirements by being corner placed on the host PCB. This product specification shows the performance of the antenna over all stated frequency ranges.

## 3. Applications

- 4G Mi-Fi Routers
- Medical equipment
- Tablets
- OBD++ systems
- MIMO Systems
- Femtocell / Pico stations
- Remote monitoring



## 4. Part Number

**Inversa: SR4L034-L**



**Inversa: SR4L034-R**

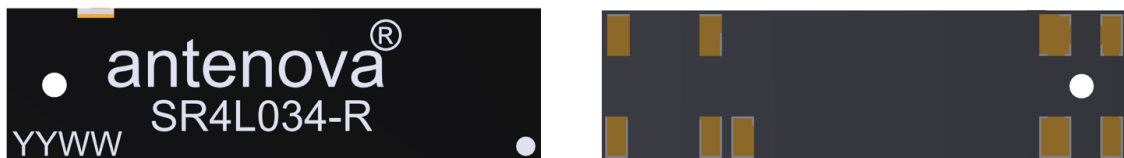

## 5. General Data

Product name	Inversa
Part Number	SR4L034-L / SR4L034-R
Frequency	698-960MHz 1710-2170MHz 2300-2400MHz 2500-2690MHz
Polarization	Linear
Operating temperature	-40°C to 140°C
Environmental Condition Test	ISO16750-4 5.1.1.1/5.1.2.1/5.3.2
Impedance with matching	50 Ω
Weight	<2.5g
Antenna type	SMD
Dimensions	28.0 x 8.0 x 3.3 (mm)

## 6. RF Characteristics

	698 - 798 MHz
Peak gain	0.40dBi
Average gain (Linear)	-2.0dBi
Average efficiency	>55%
Maximum return loss	-6.0dB
Maximum VSWR	2.8:1

	824 - 960 MHz
Peak gain	1.60dBi
Average gain (Linear)	-1.10dBi
Average efficiency	>70%
Maximum return loss	-6.6dB
Maximum VSWR	2.8:1

	1710 - 2170 MHz
Peak gain	3.50dBi
Average gain (Linear)	-2.00dBi
Average efficiency	>60%
Maximum return loss	-5.1dB
Maximum VSWR	3.5:1

	2300 - 2400 MHz
Peak gain	3.60dBi
Average gain (Linear)	-1.60dBi
Average efficiency	>60%
Maximum return loss	-7.0dB
Maximum VSWR	2.5:1

	2500 - 2690 MHz
Peak gain	2.10dBi
Average gain (Linear)	-2.30dBi
Average efficiency	>55%
Maximum return loss	-4.9dB
Maximum VSWR	3.7:1

All data measured on Antenova's evaluation PCB  
Part No. SR4L034-EVB-1

## 7. RF Performance

### 7.1 Return Loss

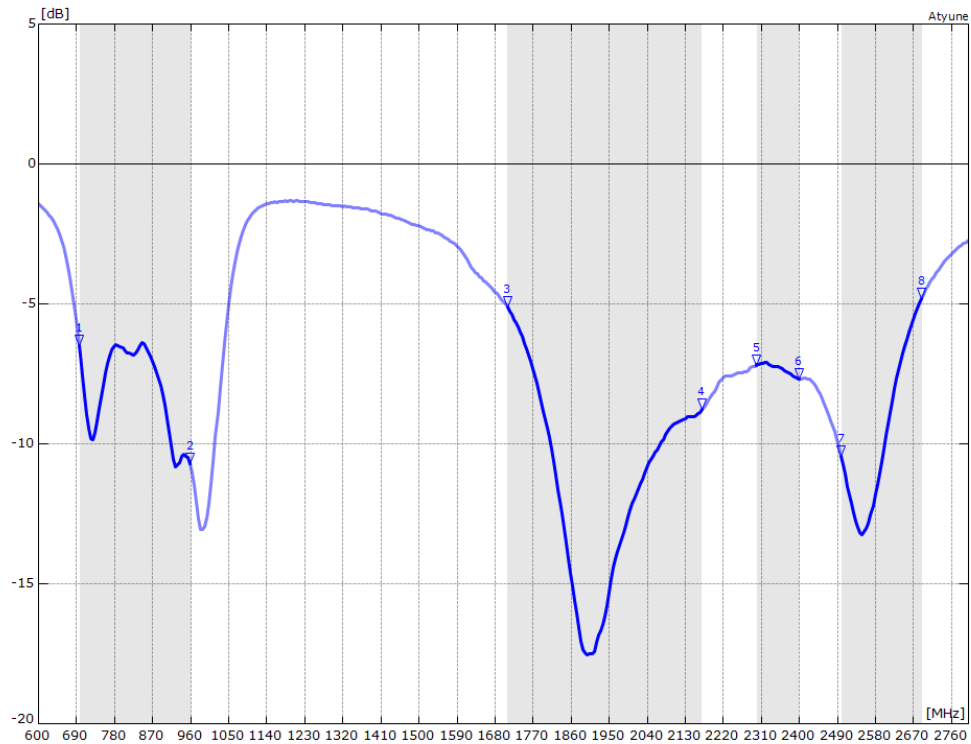

### 7.2 VSWR

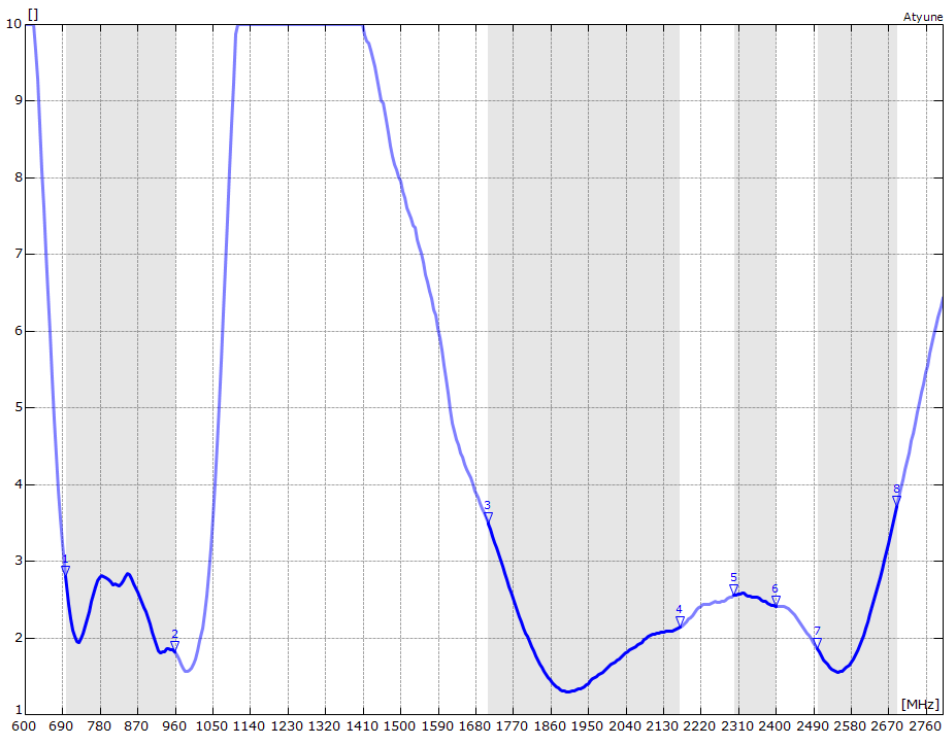

Antennas for Wireless M2M Applications



### 7.3.0 Antenna Pattern

#### 698 MHz – 798 MHz

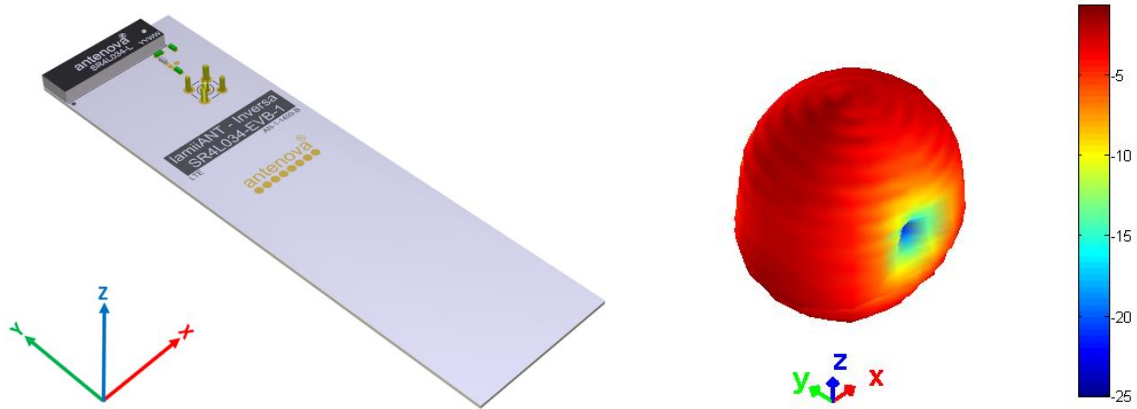

#### 3D pattern at 746 MHz

Drag to rotate pattern and PCB by using Adobe Reader  
(Click to Activate)

XY

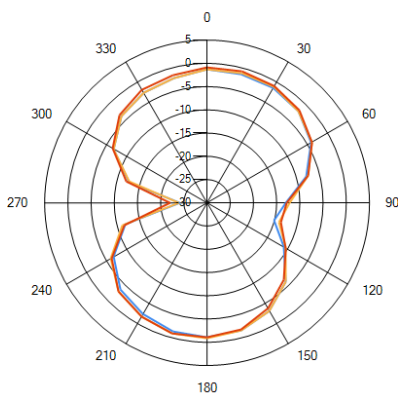

XZ

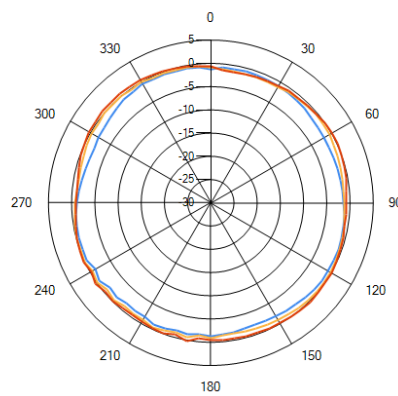

YZ

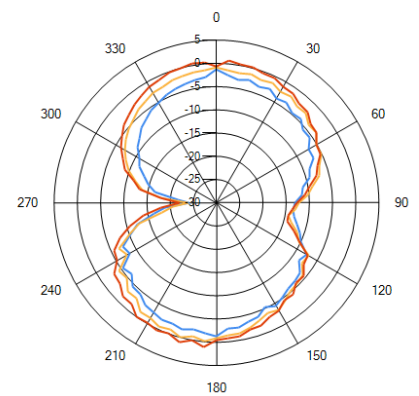

— 698MHz — 754MHz — 830MHz

Antennas for Wireless M2M Applications

### 7.3.1 Antenna Pattern

#### 824 MHz – 960 MHz

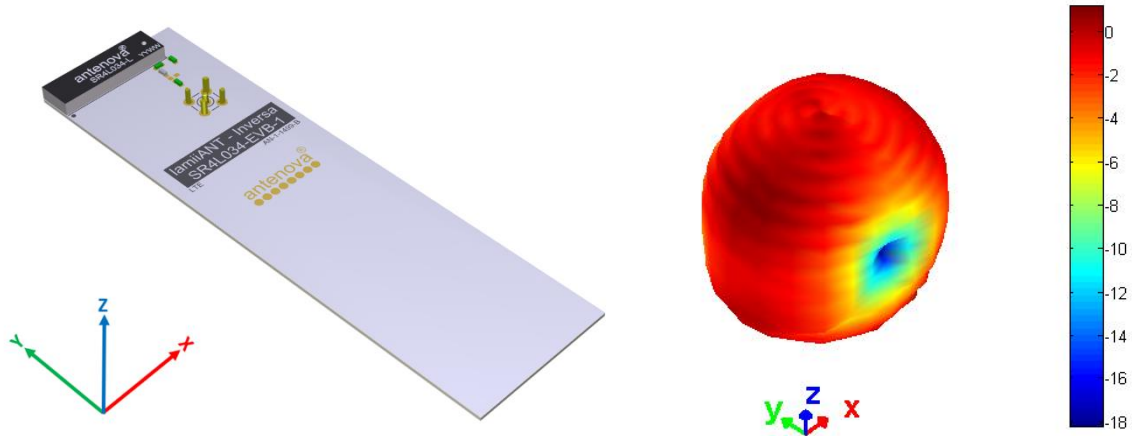

#### 3D pattern at 880 MHz

Drag to rotate pattern and PCB by using Adobe Reader  
(Click to Activate)

XY

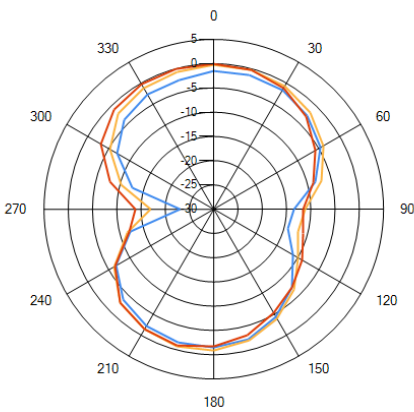

XZ

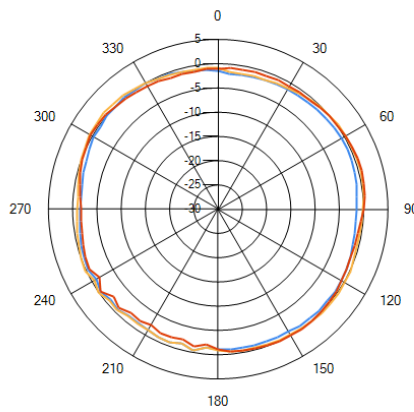

YZ

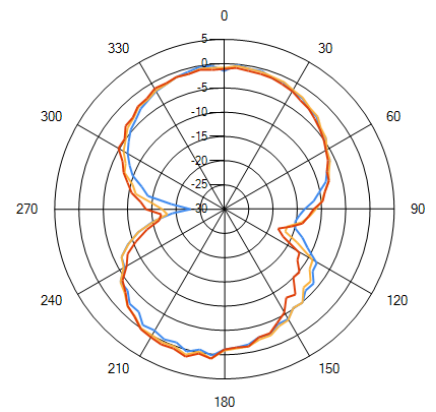

— 824MHz — 880MHz — 960MHz

### 7.3.2 Antenna Pattern

#### 1710 MHz – 2170 MHz

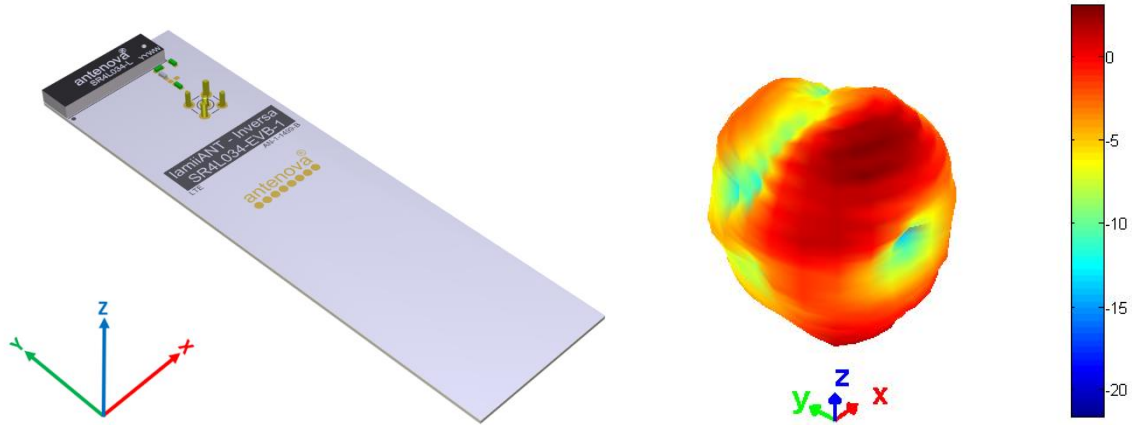

#### 3D pattern at 1990 MHz

*Drag to rotate pattern and PCB by using Adobe Reader  
(Click to Activate)*

XY

XZ

YZ

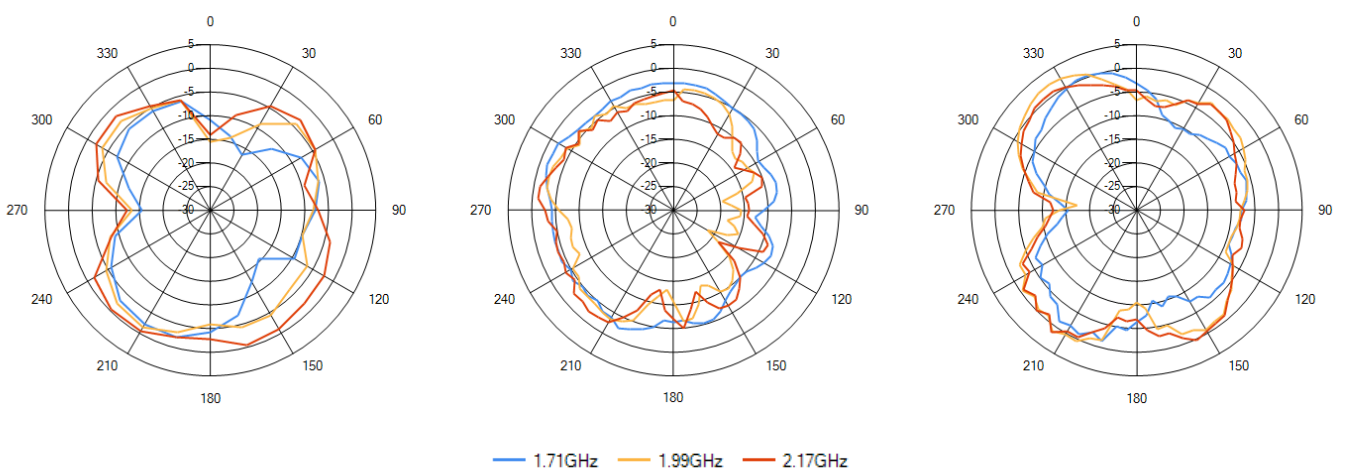

Antennas for Wireless M2M Applications

### 7.3.3 Antenna Pattern

#### 2300 MHz – 2400 MHz

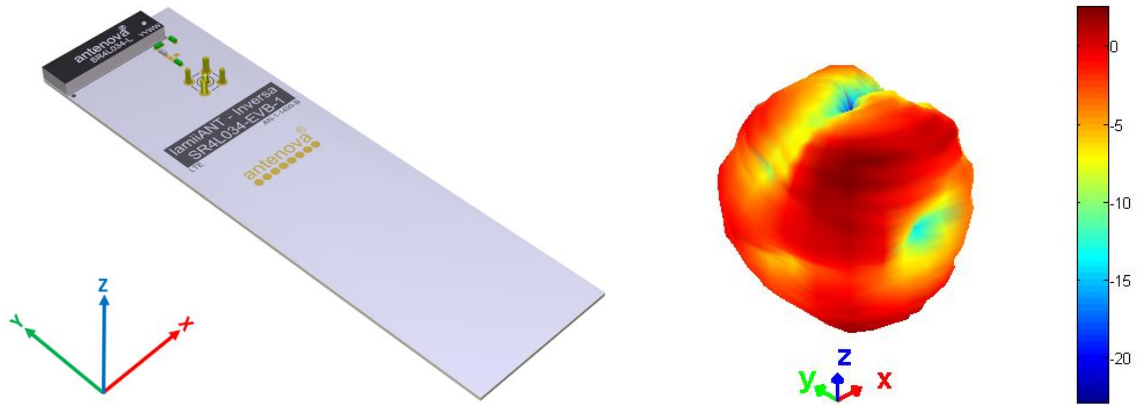

#### 3D pattern at 2.35 GHz

Drag to rotate pattern and PCB by using Adobe Reader  
(Click to Activate)

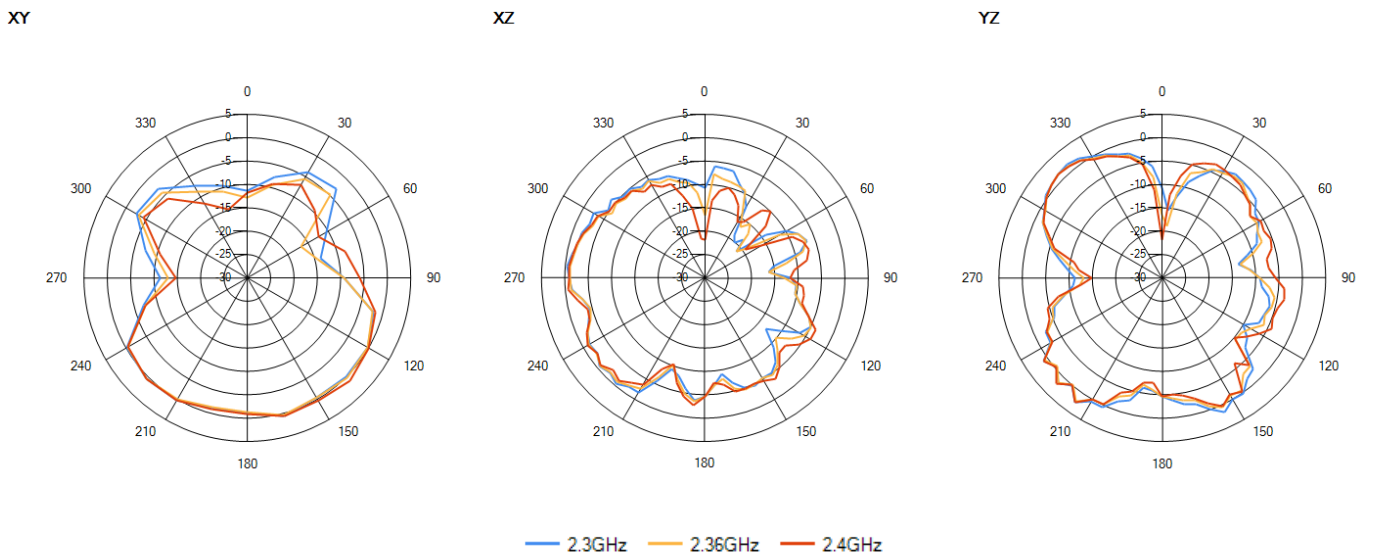

### 7.3.3 Antenna Pattern

#### 2500 MHz – 2690 MHz

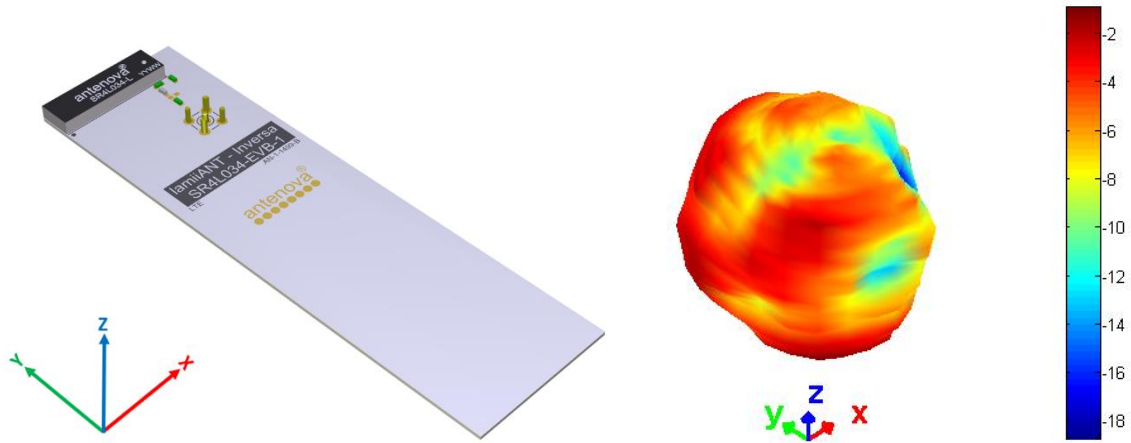

#### 3D pattern at 2.6 GHz

Drag to rotate pattern and PCB by using Adobe Reader  
(Click to Activate)

XY

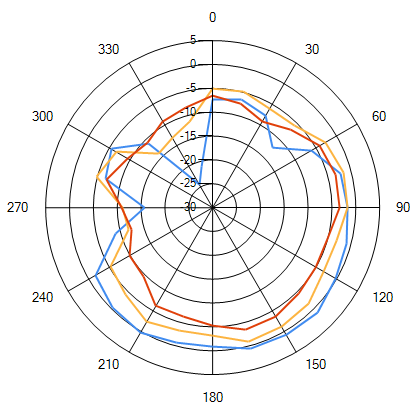

XZ

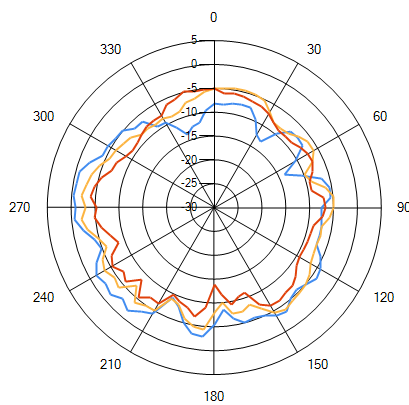

YZ

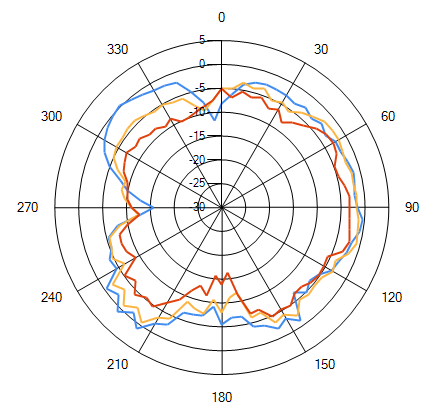

— 2.5GHz — 2.6GHz — 2.69GHz

Antennas for Wireless M2M Applications

## 7.4 Host PCB Length Vs. Efficiency

The efficiency of Inversa is shown here over varying GND plane lengths.

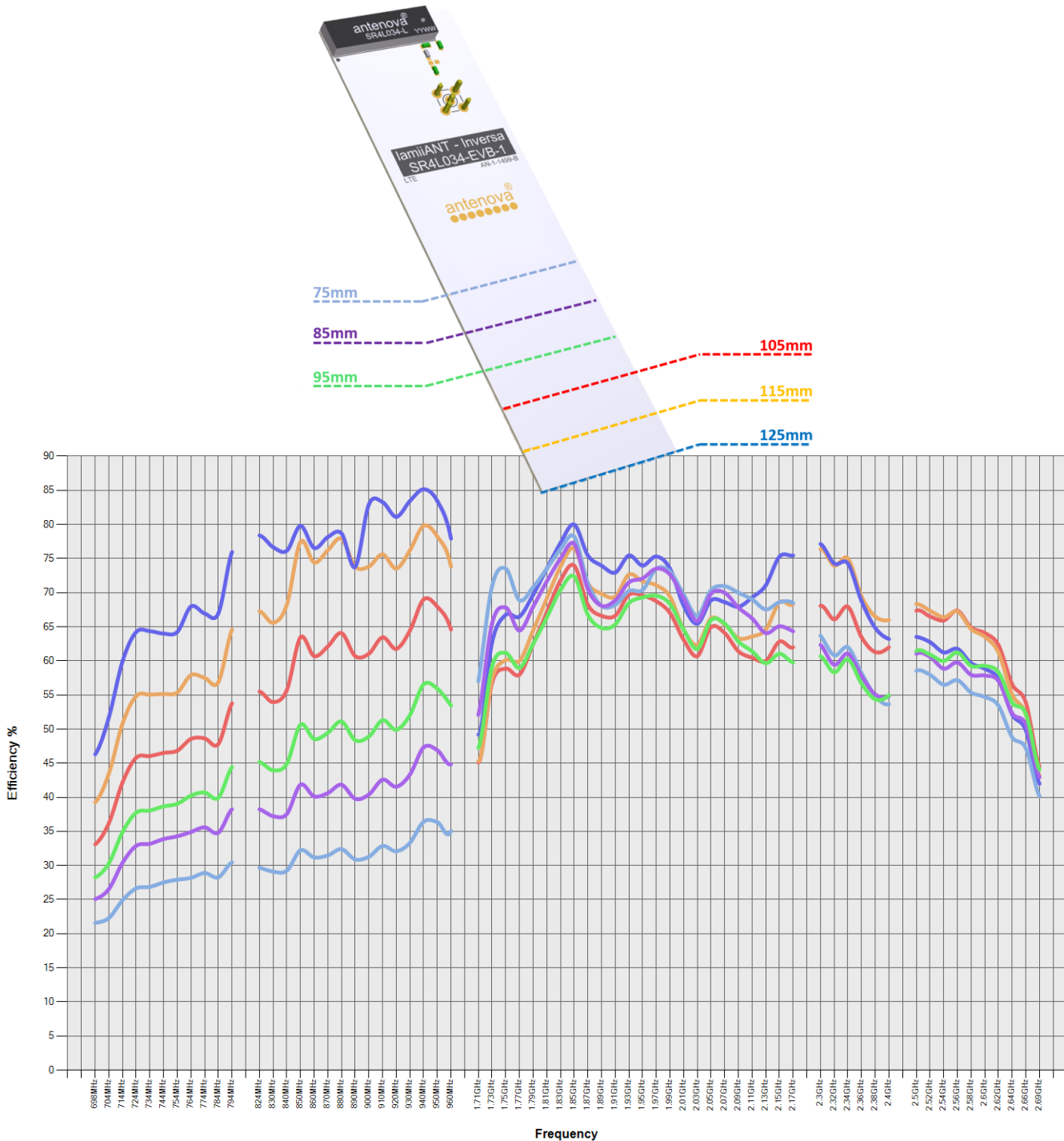

## 8. Antenna Dimensions

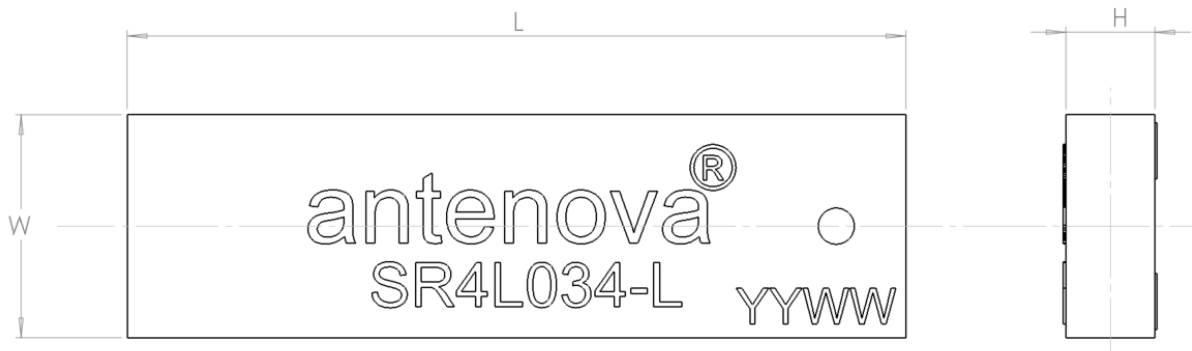

All Dimensions in (mm)  
-L and -R Dimensions are the same

L	W	H
<b>Length</b>	<b>Width</b>	<b>Height</b>
28.0 ±0.1	8.0 ±0.1	3.3 +0.1 -0.0

Bottom Side SR4L034-L

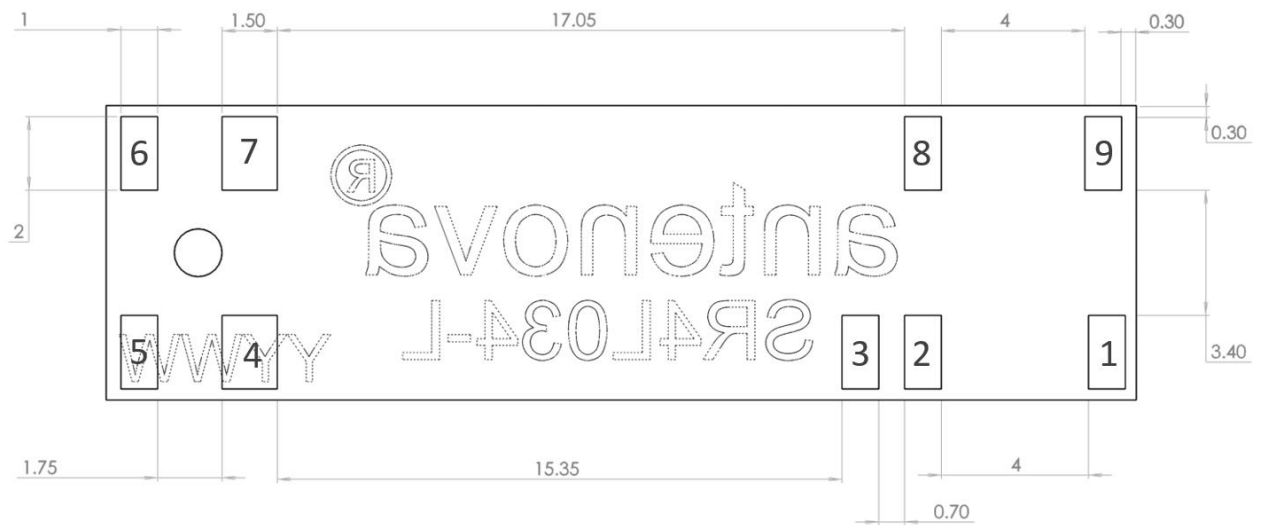

Bottom Side SR4L034-R

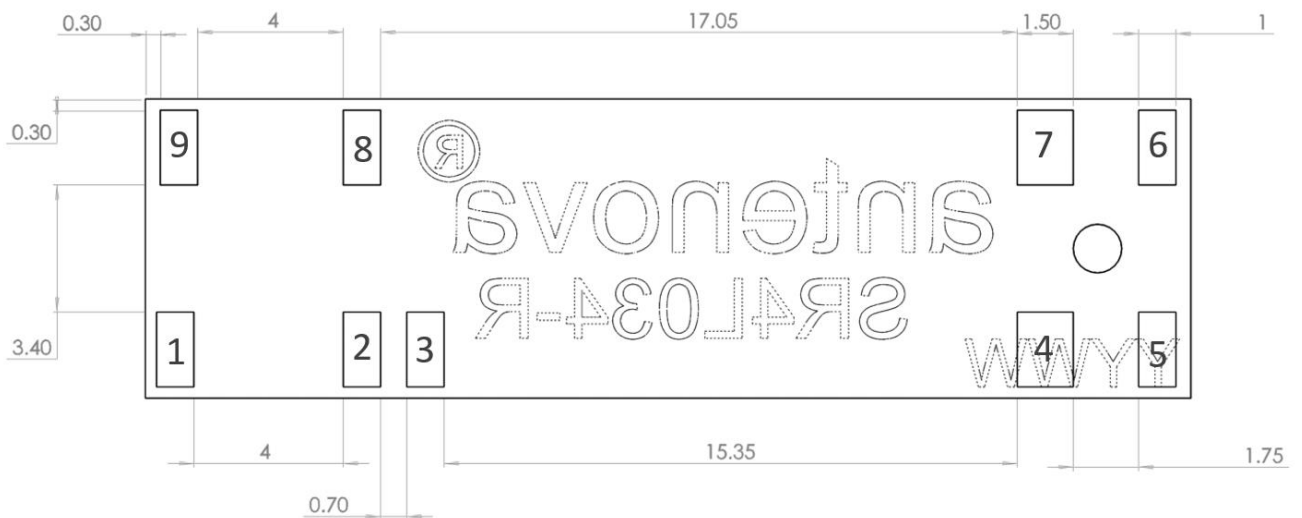

- All Dimensions in (mm)
- View from underneath each antenna



## 9.1 Schematic symbol and Pin definition

The circuit symbol for the antenna is shown below.

Pin	Name	Description
4	Feed	Transceiver port
5	T1	Return/Tuning
1,6,7,8,9	NC	Not used (Mechanical only)
2,3	SC	Pins 2 and 3 short circuit on host PCB

Inversa Schematic Symbol

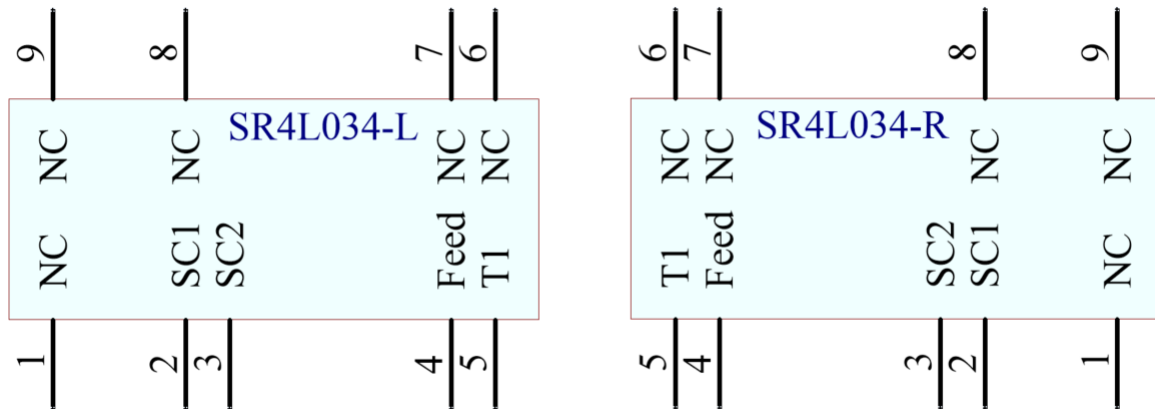

## 10.0 Antenna footprint

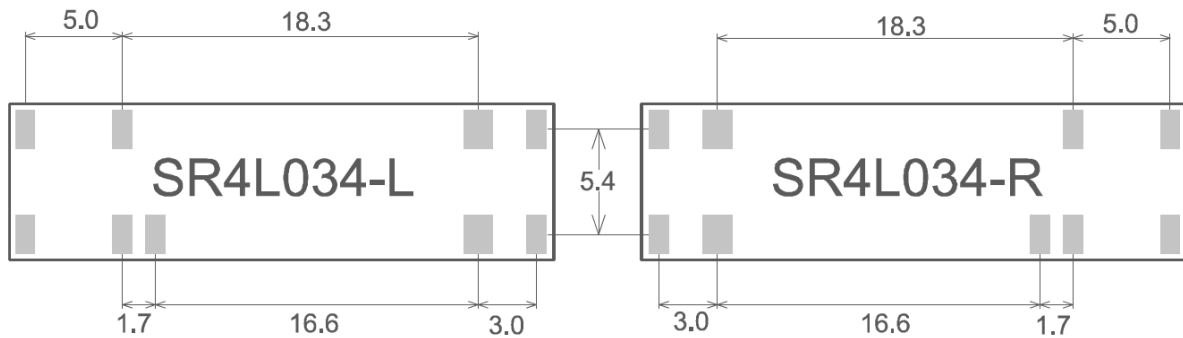

ALL DIMENSIONS IN MM

PADS 1,2,3,5,6,8,9 = 2.0 X 1.0 (MM)  
PADS 4,7 = 2.0 X 1.5 (MM)

## 10.1 Host PCB Layout

The footprint and clearance of the host PCB must be designed-in as below.

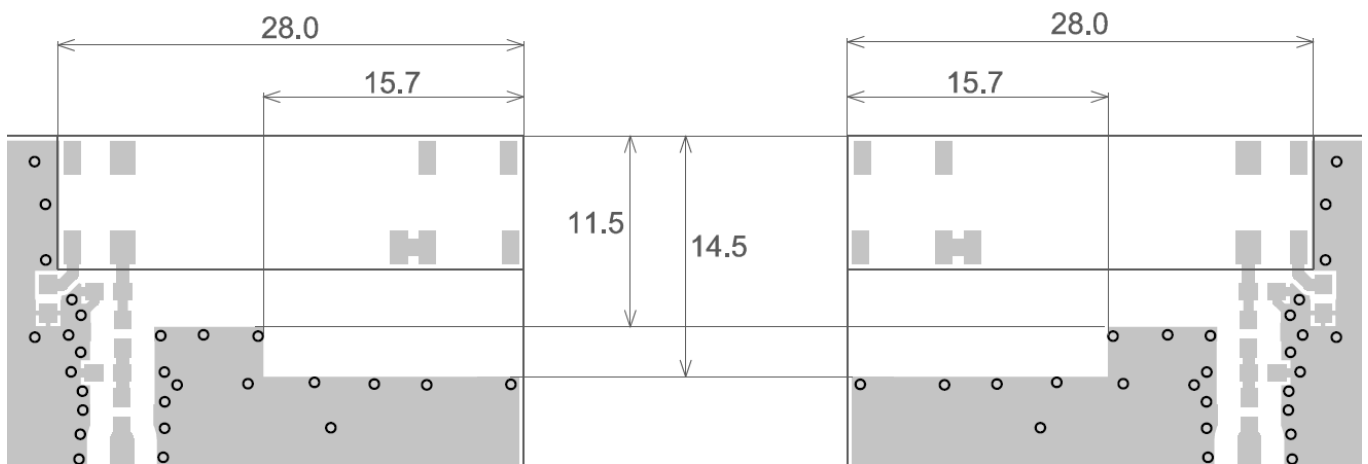

■ Copper □ Clearance ○ Via

ALL DIMENSIONS IN MM

## 11. Electrical Interface

### 11.1 Transmission Line

All transmission lines should be designed to have a characteristic impedance of 50Ω.

- The length of the transmission lines should be kept to a minimum.
- Any other parts of the RF system like transceivers, power amplifiers, etc, should also be designed to have an impedance of 50 Ω.

Once the material for the PCB has been chosen (PCB thickness and dielectric constant), a coplanar transmission line can easily be designed using any of the commercial software packages for transmission line design. For the chosen PCB thickness, copper thickness and substrate dielectric constant, the program will calculate the appropriate transmission line width and gaps on either side of the track, so the characteristic impedance of the coplanar transmission is 50 Ω.

### 11.2 Matching Circuit

The antenna requires a matching circuit that must be optimized for each product. The matching circuit will require up to six components, the following circuit should be designed into the host PCB. Not all of the components may be required, but they should be included as a precaution. The matching network must be placed close to the antenna feed to ensure it is more effective in tuning the antenna.

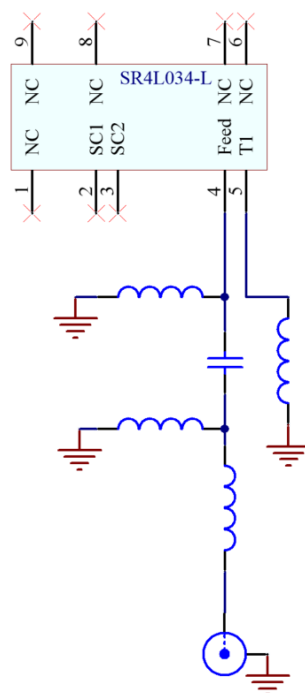

## 12.0 Antenna Integration Guide

### 12.1 Antenna Placement

The antenna should ideally be placed on the host PCB using one of the two configurations below.

#### 1) Horizontal placement

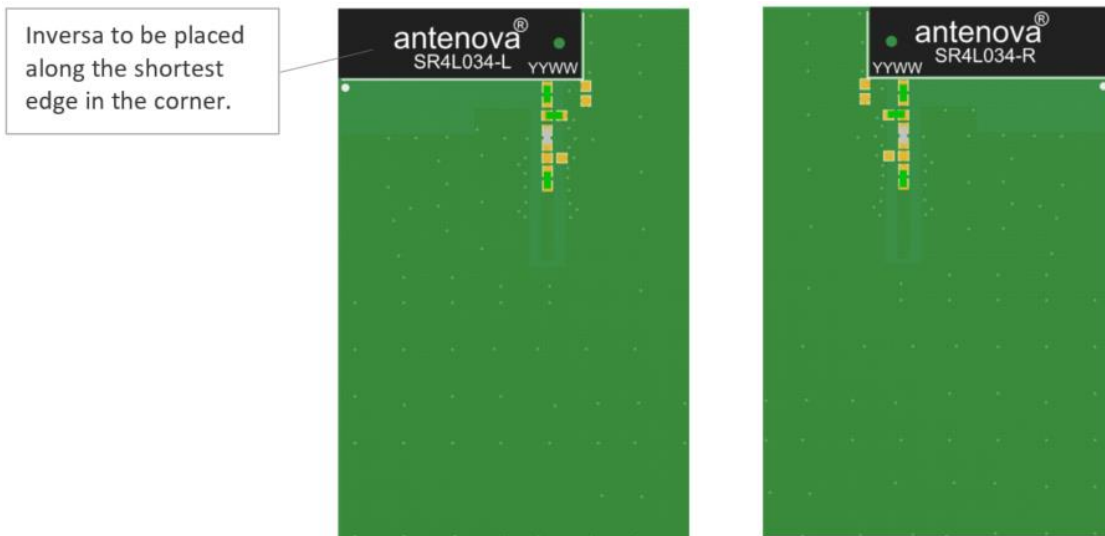

#### 2) Vertical placement

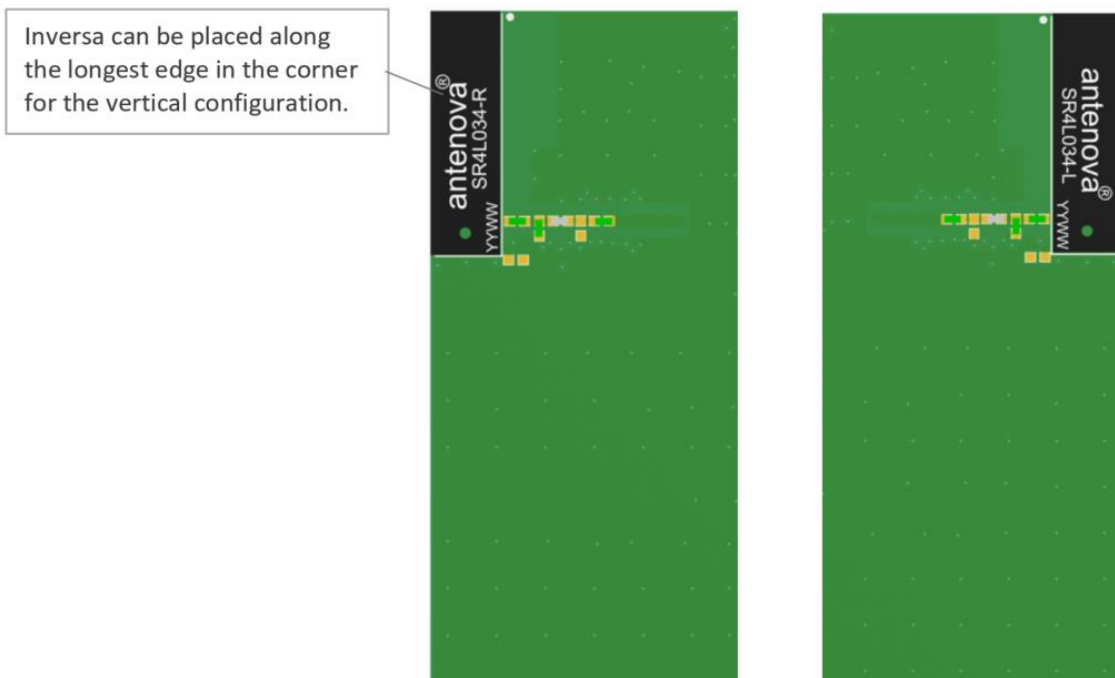

**Note:** Vertical placement optimal minimum GND length required is  $\geq 100\text{mm}$

## 12.2 Diversity Placement

For a Diversity solution, use 2 x Inversa antennas on the same host PCB. For all configurations the distance between them should be  $\geq 15\text{mm}$

*Please note: It is still advisable to consult Antenova before building the PCB for additional checking of the layout and device.*

### Proximity configurations

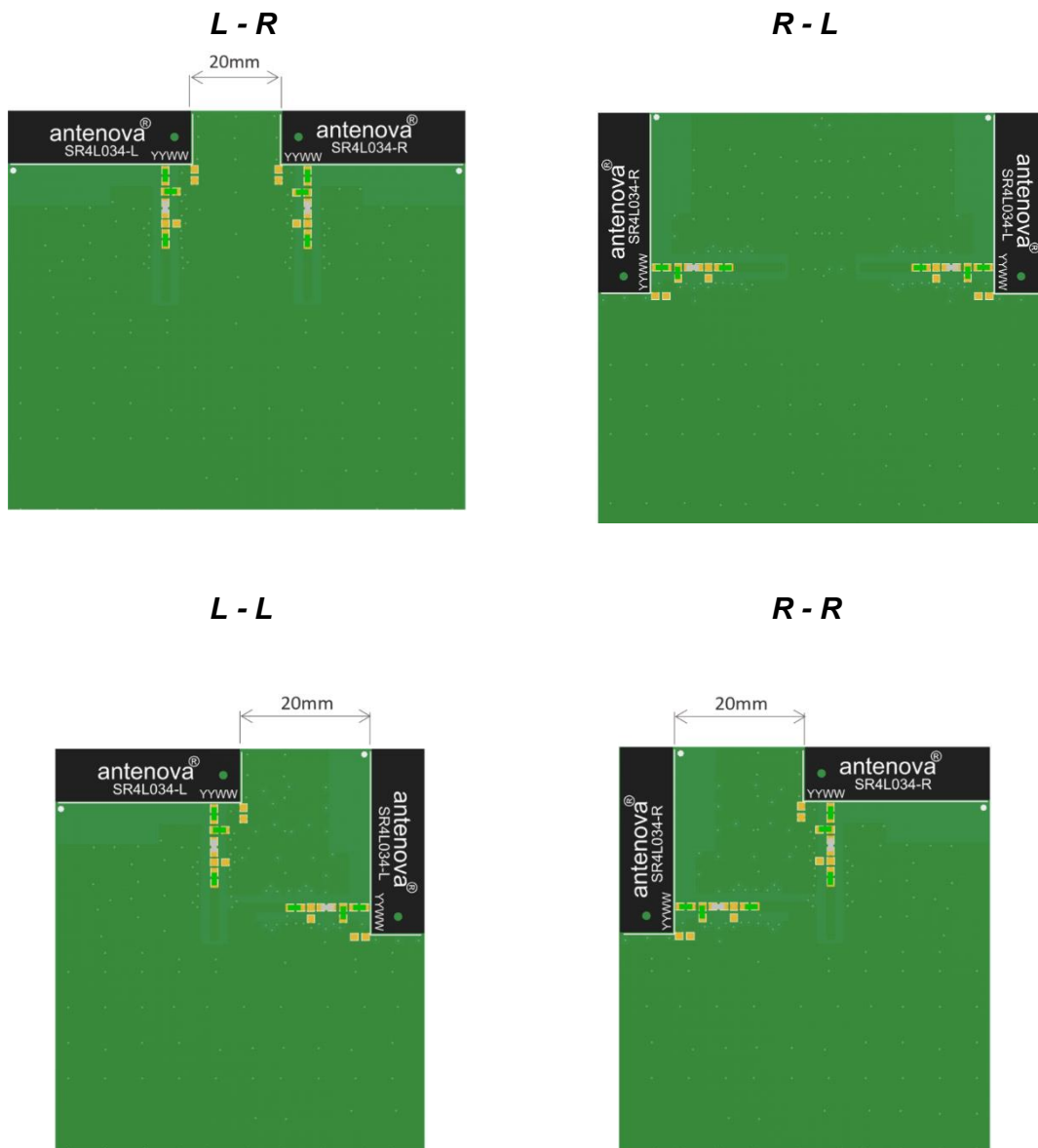

### Opposed configurations

*L - R*

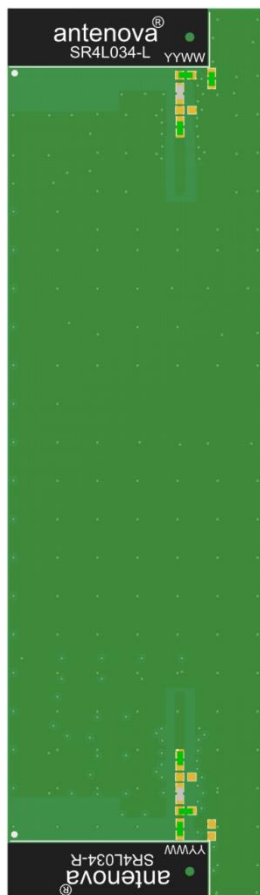

*L - L*



## 12.3 Isolation

The Isolation vs. Distance from Main to Diversity. 40mm, 25mm and 20mm are shown for comparison.

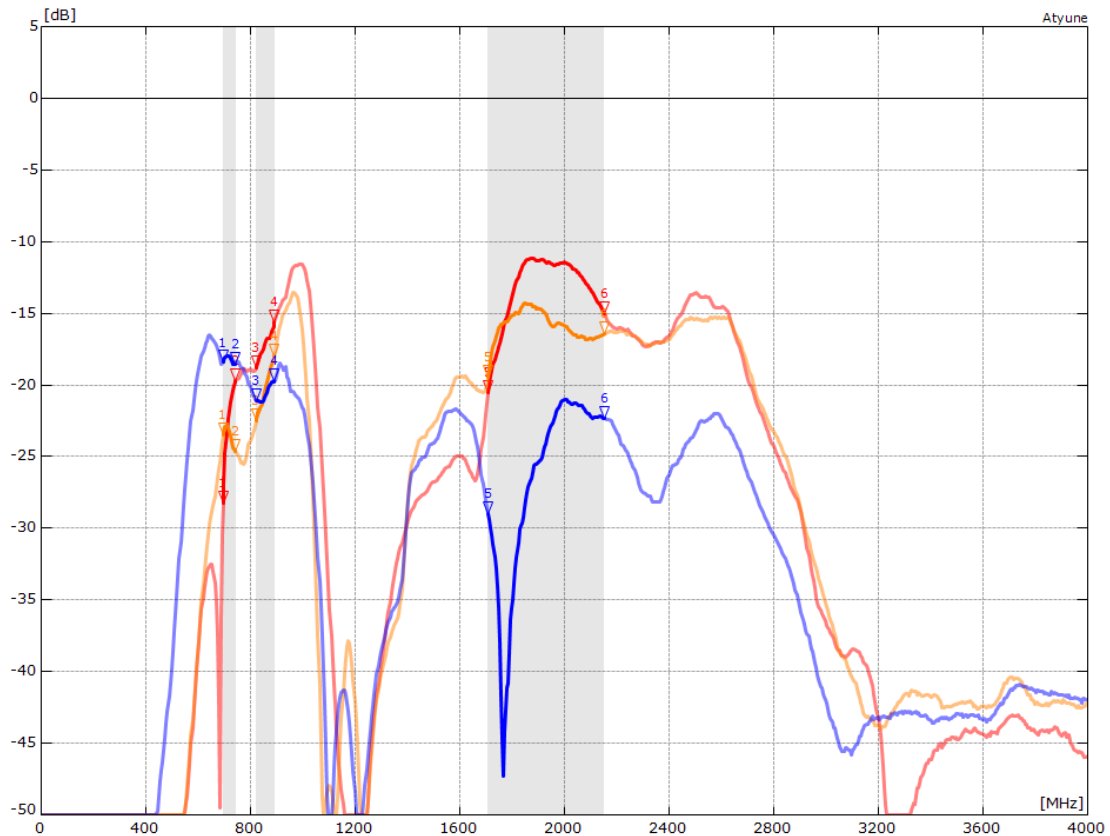

MARKERS: MHz    dB    MHz    dB    MHz    dB					
ISOLATION 20MM.S2P - S21					
1:	698	-28.22	3:	824	-18.77
2:	746	-19.70	4:	894	-15.54
5:	1710	-20.48	6:	2155	-15.00
ISOLATION 25MM.S2P - S21					
1:	698	-23.46	3:	824	-22.45
2:	746	-24.57	4:	894	-17.91
5:	1710	-19.45	6:	2155	-16.42
ISOLATION 40MM.S2P - S21					
1:	698	-18.39	3:	824	-21.06
2:	746	-18.50	4:	894	-19.68
5:	1710	-28.92	6:	2155	-22.25

## 12.4 Radiation Pattern Diversity

The radiation pattern for SR4L034-EVB-2 Diversity example is shown below for each antenna on two different bands.

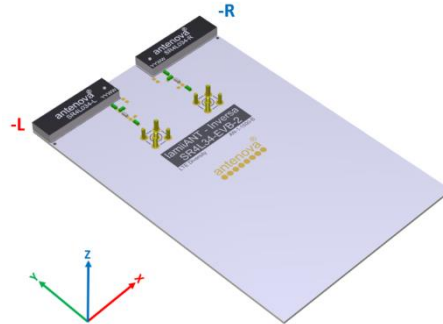

### 698 MHz – 960 MHz (3D pattern at 880 MHz)

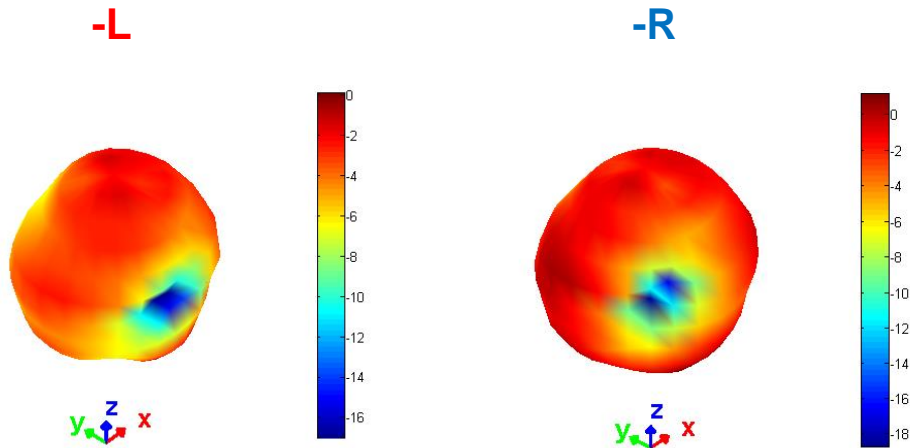

### 1710 MHz – 2170 MHz (3D pattern at 1990 MHz)

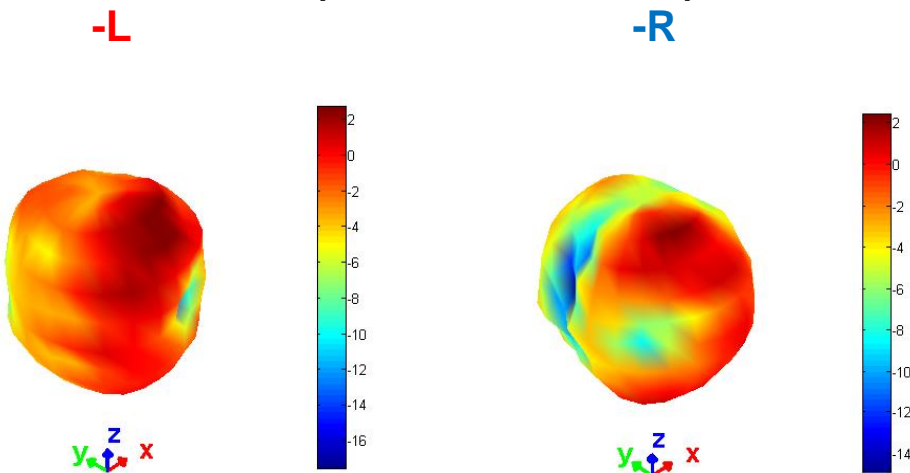

*Drag to rotate pattern and PCB by using Adobe Reader  
(Click to Activate)*



## 12.5 Component Distance Rule

While it is ideal to keep the antenna away from metal objects and other PCB components, it is possible to have components around the antenna. No set distance is set and it varies depending on the height of the component. So rather than setting a defined distance a rule can be given. An 8° projection line can be drawn from the base of the antenna. This can then be used to decide the distance a component can be.

The example below shows a USB connector placed using this rule. Once it is within the 8° limit the distance is known.

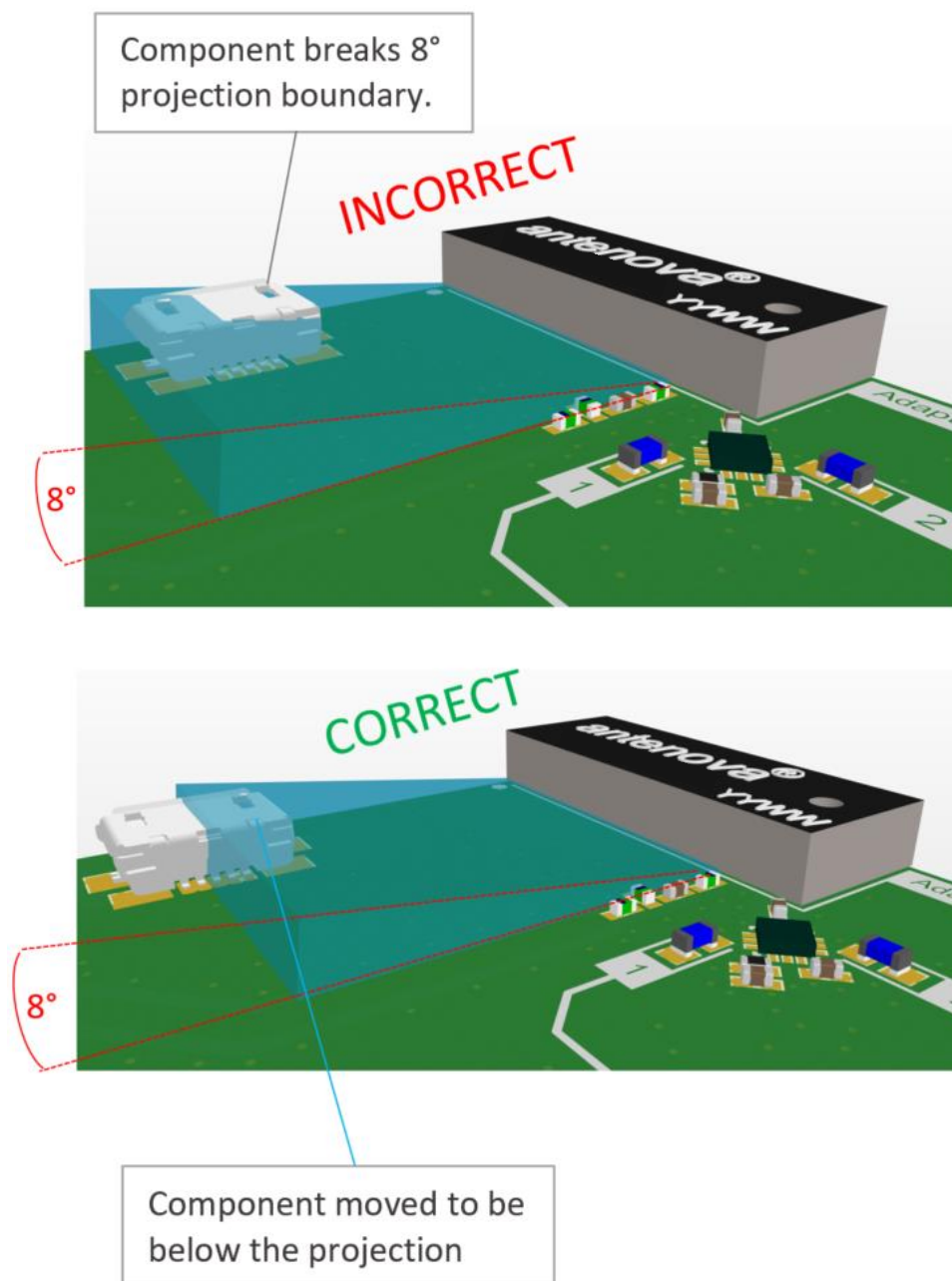

## 13.0 Antenna Active Tuning for Smaller GND planes

For a host PCB with a length less than 75mm it is suggested to use an active tuning circuit to overcome the BW reduction seen with smaller GND. This can be implemented on a single antenna or diversity solution. An Antenova EVB kit is available with this circuit (SR4L034-EVB-3).

The SR4L034-EVB-3 evaluation PCB uses a simple RF switching circuit to select between two component values on the RTN (Pin5). In this kit the RF switch used is a Peregrine PE423422.

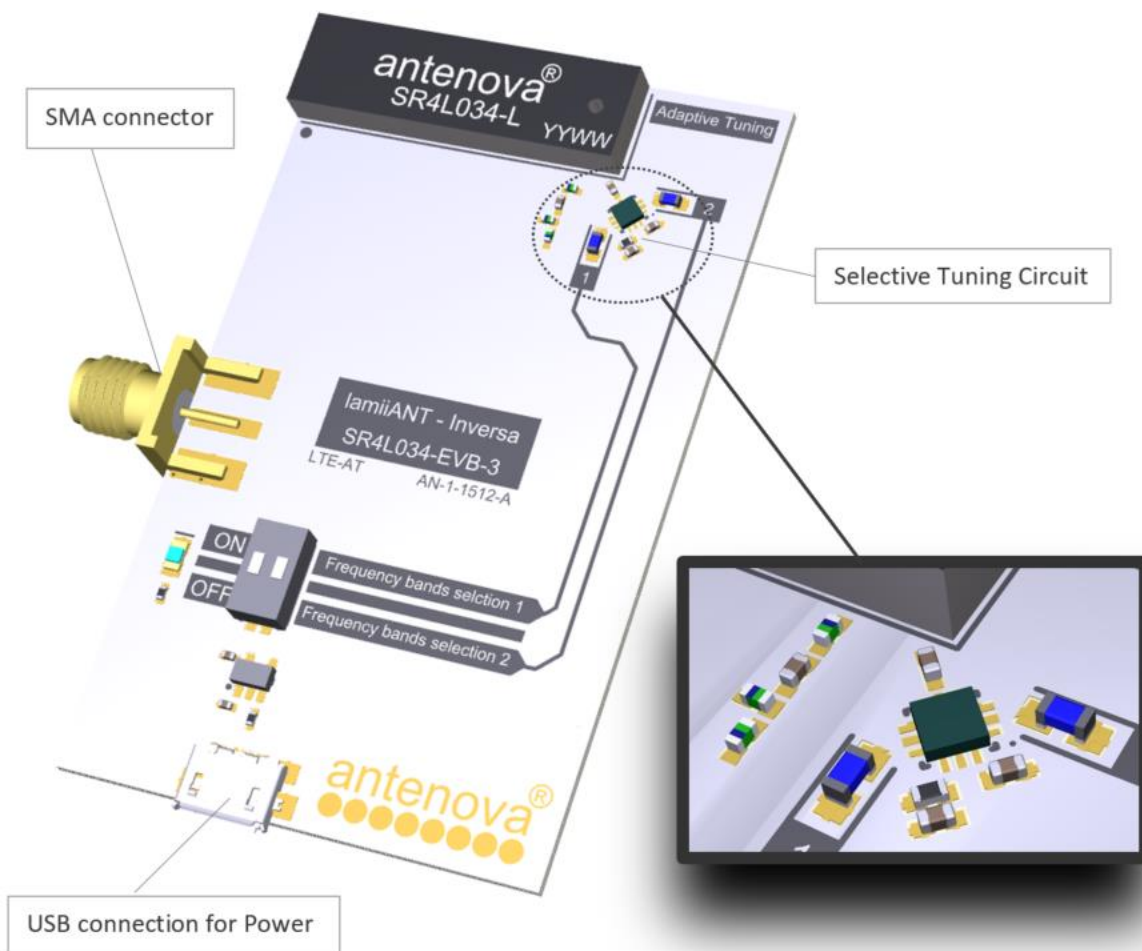

SR4L034-EVB-3 = 65 x 40 (mm)

### 13.1 Antenna Active Tuning Circuit

Reference circuit using the Peregrine PE423422. The input matching circuit and L4 and L5 values are dependent on the host PCB/Device.

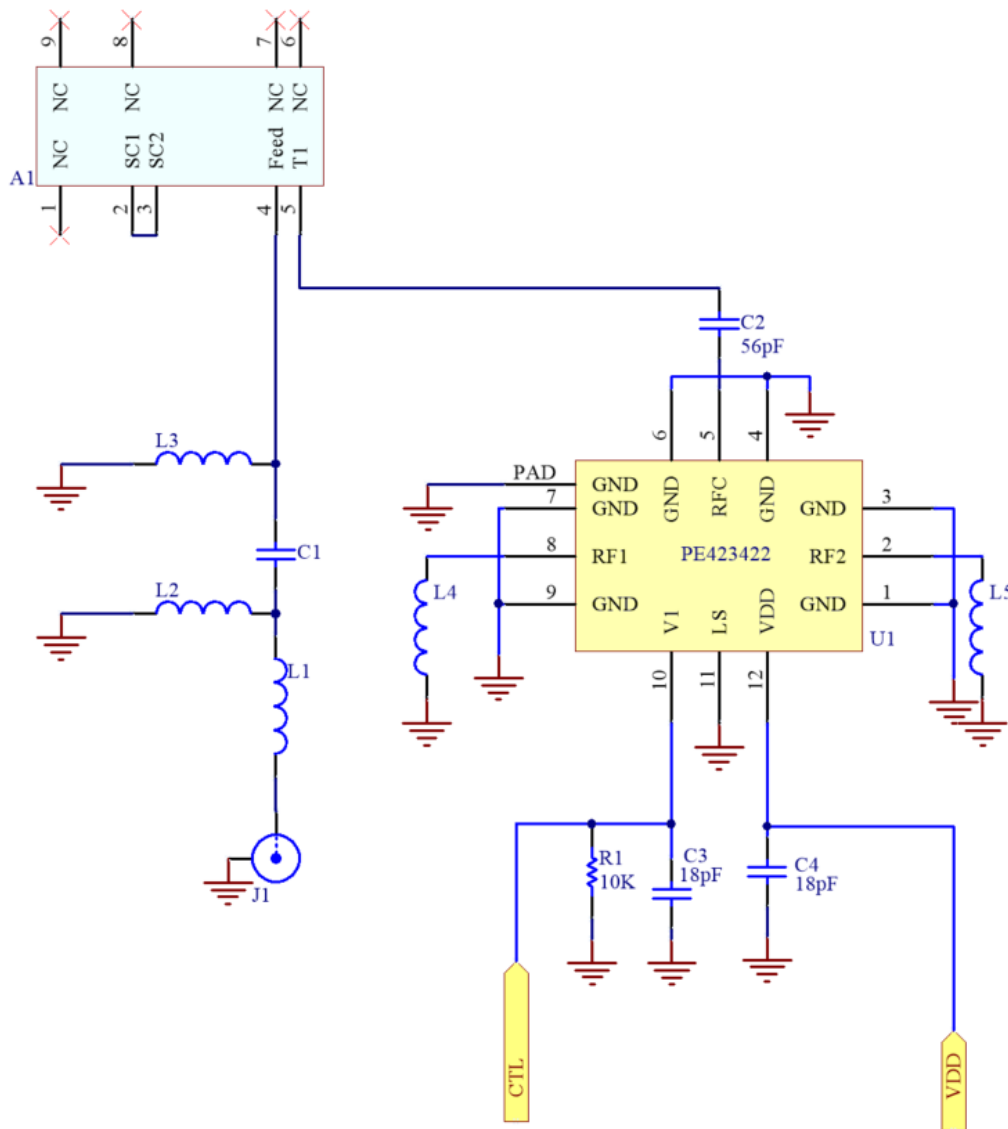

Designator	Type	Value	Description
U1	RF Switch	PE423422	Peregrine RF SPDT
R1	Resistor	10K	Pull Down
C3, C4	Capacitor	18pF	De-coupler
C2	Capacitor	56pF	DC-Block
L4,L5	Tuning Cap / Ind	-	Dependant on Device
L1,L2,C1,L3	Matching	-	Dependant on Device

## 13.2 Antenna Active Tuning Circuit Performance

The SR4L034-EVB-3 was tested in the following configuration:

**1 = 698-746MHz;** 1710-2155MHz

**2 = 824-960MHz;** 1710-2155MHz

	698 - 746 MHz	824 - 960 MHz
Peak gain	-2.5dBi	-1.0dBi
Average gain (Linear)	-4.2dBi	-2.8dBi
Average efficiency	>30%	>35%
Maximum return loss	<-4.2dB	<-4.1dB
Maximum VSWR	4.0:1	3.9:1

## 13.3 Return Loss

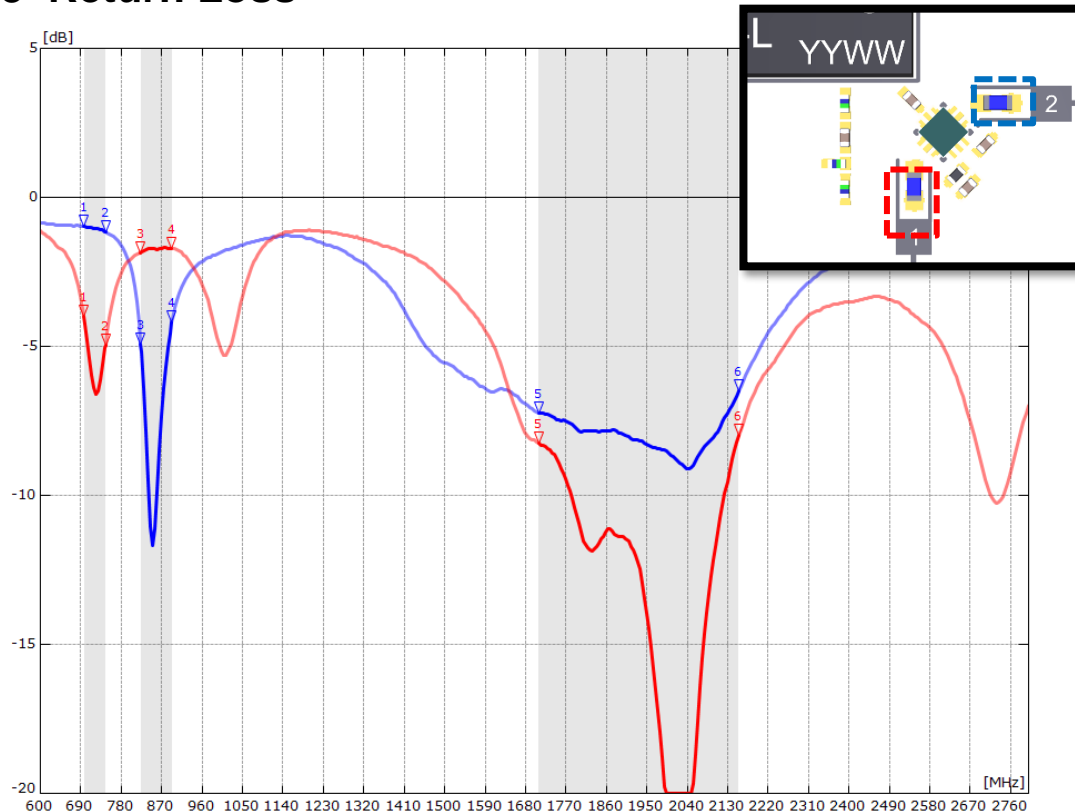

## 14.0 Reference Board

The reference board has been designed for evaluating the SR4L034-L antenna. It includes an SMA female connector.

### SR4L034-EVB-1 Evaluation Board

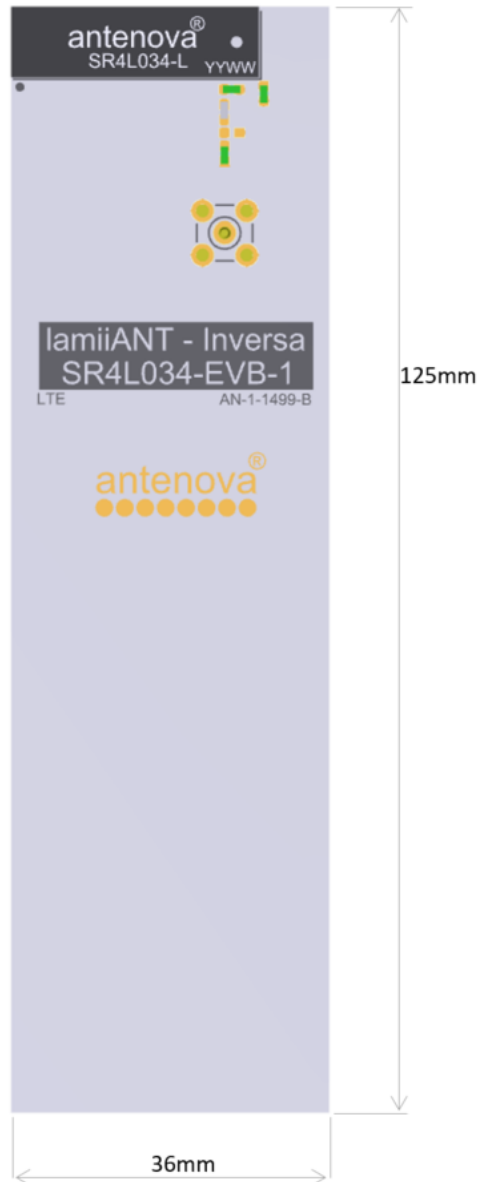

To order a reference board contact [sales@antenna-m2m.com](mailto:sales@antenna-m2m.com).  
Please state if a single antenna or two antenna EVB is required.

## 14.1 SR4L034-EVB-1 Matching Circuit

The reference board has been designed for evaluating SR4L034 and includes an SMA female connector.

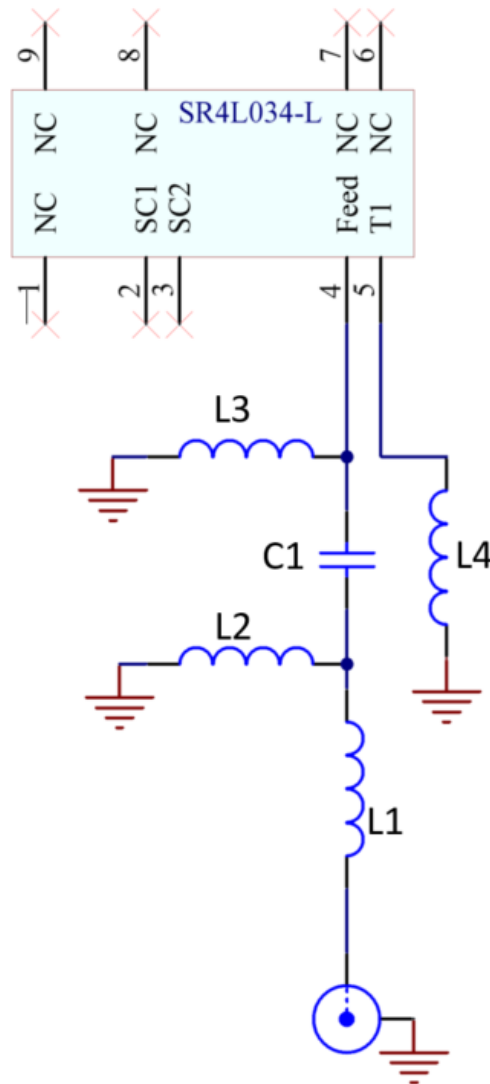

Designator	Type	Value	Description
L1	Resistor	0R	Non - Specific
L2	Inductor	22nH	Murata LQG15HN
C1	Capacitor	1.8pF	Murata GJM15
L3	Inductor	39nH	Murata LQG15HN
L4	Inductor	6.8nH	Murata LQG15HN

## 14.2 Diversity EVB Active Tuning EVB

Two more versions of the Inversa evaluation board are available. Please contact Antenova for more information.

### SR4L034-EVB-2 (Diversity Example)

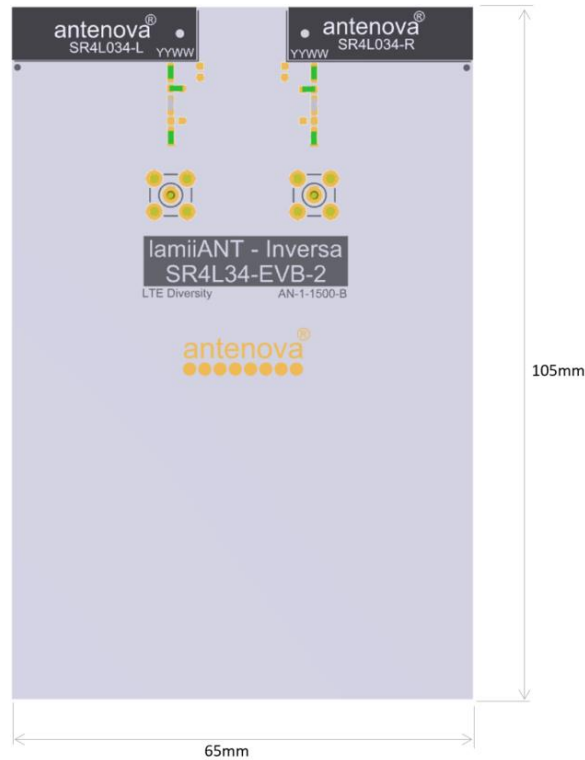

### SR4L034-EVB-3 (Active Tuning Solution)

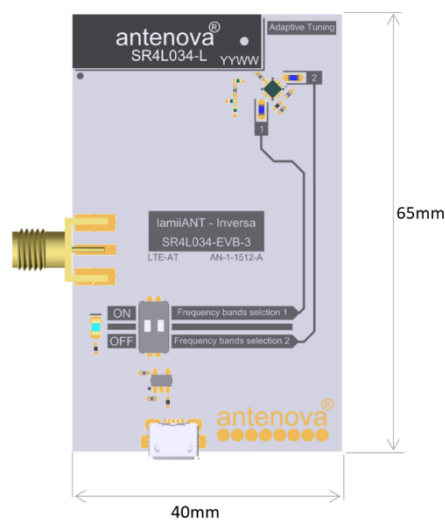

To order a reference board contact [sales@antenova-m2m.com](mailto:sales@antenova-m2m.com). Please state if a single antenna or two antenna EVB is required.

Antennas for Wireless M2M Applications

## 15. Soldering

This antenna is suitable for lead free soldering.

The reflow profile should be adjusted to suit the device, oven and solder paste, while observing the following conditions:

- The maximum temperature should not exceed 240 °C.
- However, for lead free soldering, a maximum temperature of 255 °C for no more than 20 seconds is permitted.
- The antenna should not be exposed to temperatures exceeding 120 °C more than 3 times during the soldering process.

## 16. Hazardous Material Regulation Conformance

The antenna has been tested to conform to RoHS requirements. A certificate of conformance is available from Antenova M2M's website.

## 17. Packaging

### 17.1 Optimal Storage Conditions

Temperature	-10°C to 40°C
Humidity	Less than 75% RH
Shelf life	24 Months
Storage place	Away from corrosive gas and direct sunlight
Packaging	Reels should be stored in unopened sealed manufacturer's plastic packaging.

**Note: Storage of open reels of antennas is not recommended due to possible oxidization of pads on antennas. If short term storage is necessary, then it is highly recommended that the bag containing the antenna reel is re-sealed and stored in like storage conditions as in above table.**



## 17.2 Tape Characteristics

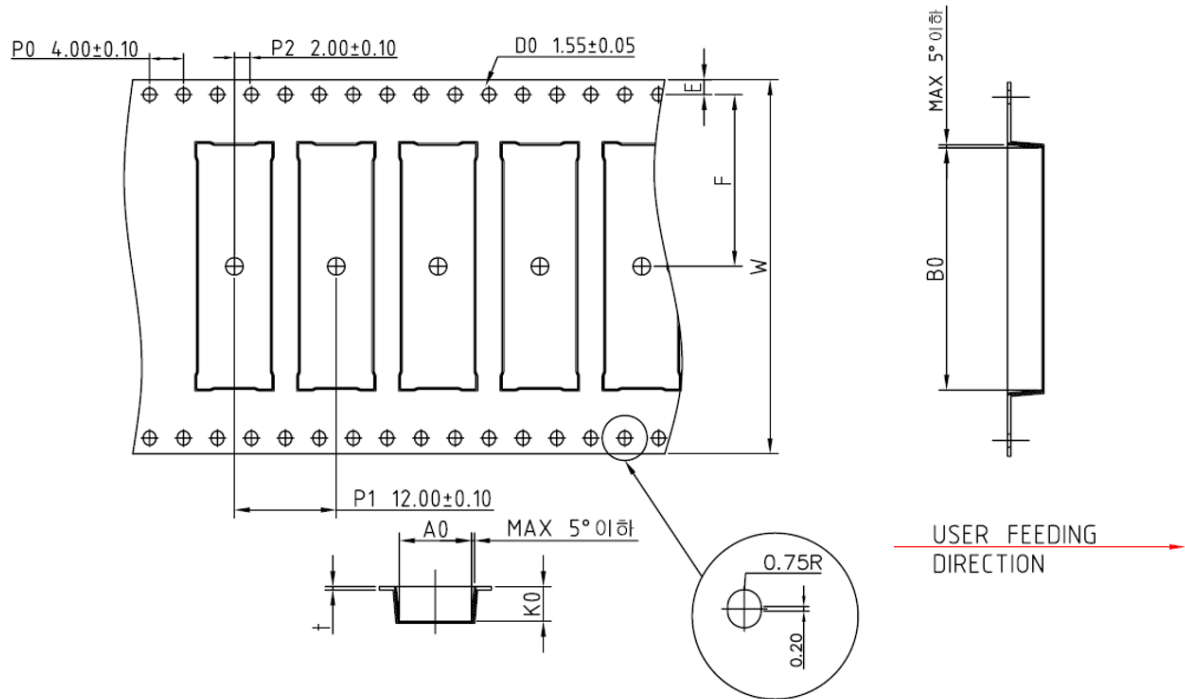

Ko	Ao	Bo	P0	P1	P2
4.10 ± 0.1	8.50 ± 0.1	28.50 ± 0.1	4.00 ± 0.1	12.00 ± 0.1	2.00 ± 0.1

E	F	W	t
1.75 ± 0.1	20.20 ± 0.15	44.00 ± 0.3	0.30 ± 0.05

Dimensions in mm

### Notes:

- 1) 10 sprocket hole pitch cumulative tolerance  $\pm 0.2$
- 2) Camber not to exceed 1mm in 100mm
- 3) Ao and Bo measured on a plane 0.1mm above the bottom of the pocket
- 4) Ko measured from a plane on the inside bottom of the pocket to the top surface of the carrier

### 17.3 Reel Dimensions

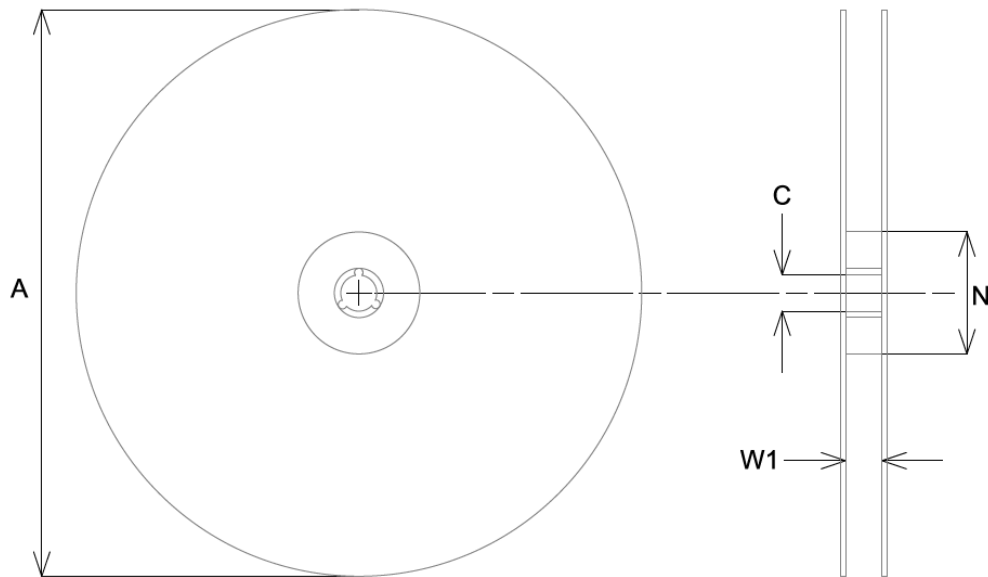

A	C	N	W1
330.0 ± 2.0	13.0 ± 0.5	178.0 ± 0.2	45 ± 0.3

All dimensions in mm

## 17.4 Box Dimensions



Length (L)	Width (W)	Thickness (T)
350mm	340mm	65mm



## 17.5 Bag Properties

Reels are supplied in protective plastic packaging.

## 17.6 Reel Label Information

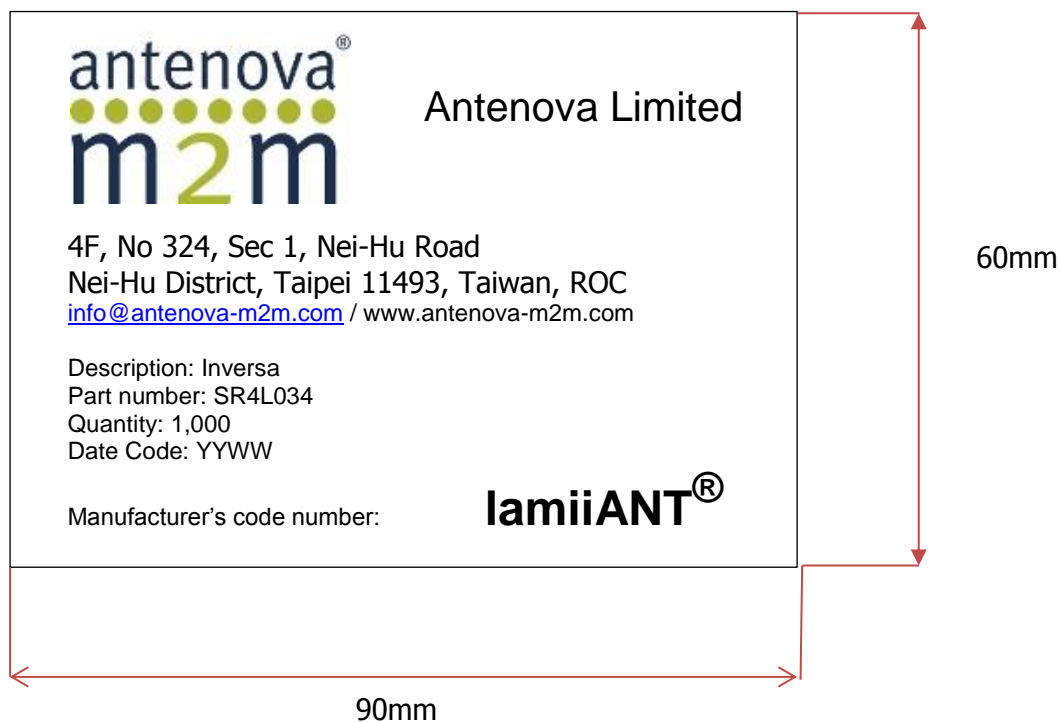



[www.antenova-m2m.com](http://www.antenova-m2m.com)

#### Corporate Headquarters

Antenova Limited  
2<sup>nd</sup> Floor Titan Court  
3 Bishop Square  
Hatfield  
AL10 9NA  
UK

**Tel:** +44 1223 810600

**Email:** [sales@antenova-m2m.com](mailto:sales@antenova-m2m.com)

#### North America Headquarters

Antenova Limited  
100 Brush Creek Road  
Suite 103, Santa Rosa  
California 95404,  
USA

**Tel:** +1 707 890 5202

**Email:** [sales@antenova-m2m.com](mailto:sales@antenova-m2m.com)

#### Asia Headquarters

Antenova Asia Limited  
4F, No. 324, Sec. 1, Nei-Hu Road  
Nei-Hu District  
Taipei 11493  
Taiwan, ROC

**Tel:** +886 (0) 2 8797 8630

**Fax:** +886 (0) 2 8797 6890

**Email:** [sales@antenova-m2m.com](mailto:sales@antenova-m2m.com)

**Copyright© Antenova Ltd.** All Rights Reserved. Antenova®, Antenova M2M®, gigaNOVA®, the Antenova product family names, and the Antenova and Antenova M2M logos are trademarks and/or registered trademarks of Antenova Ltd. Any other names and/or trademarks belong to their respective companies.

The materials provided herein are believed to be reliable and correct at the time of printing. Antenova does not warrant the accuracy or completeness of the information, text, graphics or other items contained within this information. Antenova further assumes no responsibility for the use of this information, and all such information shall be entirely at the user's risk.



Certificate No. 11070  
ISO 9001

Antennas for Wireless M2M Applications

# Mouser Electronics

Authorized Distributor

Click to View Pricing, Inventory, Delivery & Lifecycle Information:

[Antenova:](#)

[SR4L034-R](#) [SR4L034-L](#) [SR4L034-EVB-1](#) [SR4L034-EVB-3](#)