

## LISA3-RS-PIN

~15° spot beam with location pin installation

### TECHNICAL SPECIFICATIONS:

Dimensions	Ø 10.0 mm
Height	7.9 mm
Fastening	glue
ROHS compliant	yes 

### MATERIAL SPECIFICATIONS:

Component	Type	Material	Colour	Finish
LISA3-RS	Single lens	PMMA	clear	
LISA3-HLD-PIN	Holder	PC	black	



### ORDERING INFORMATION:

Component	Type	Qty in box	MOQ	MPQ	Box weight (kg)
FP16558_LISA3-RS-PIN » Box size: 310 x 230 x 60 mm	Single lens	2000	300	100	1.3

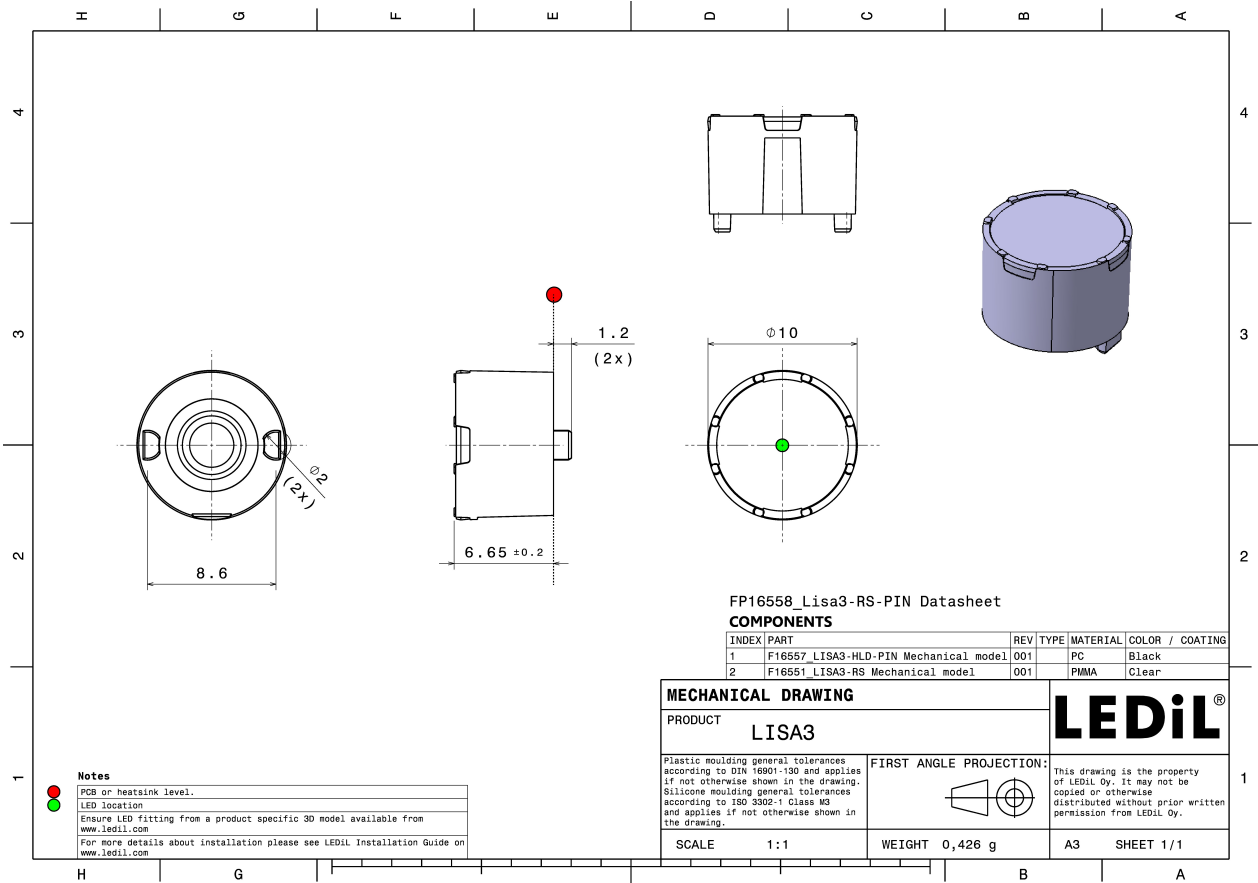

#### PHOTOMETRIC DATA (MEASURED):



LED NF2x757G  
FWHM 25.0°  
Efficiency 88 %  
Peak intensity 3.3 cd/lm  
LEDs/each optic 1  
Light colour White  
Required components:

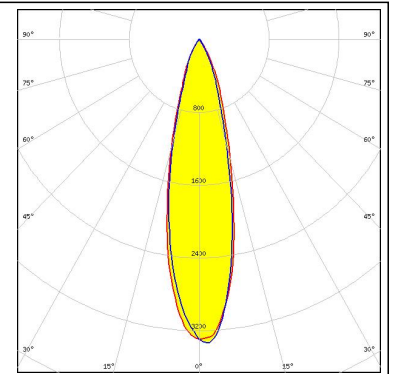
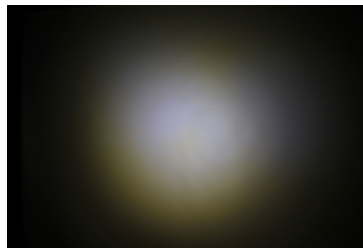

#### PHOTOMETRIC DATA (SIMULATED):



LED XP-E  
 FWHM 15.0°  
 Efficiency 90 %  
 Peak intensity 8.5 cd/lm  
 LEDs/each optic 1  
 Light colour White  
 Required components:

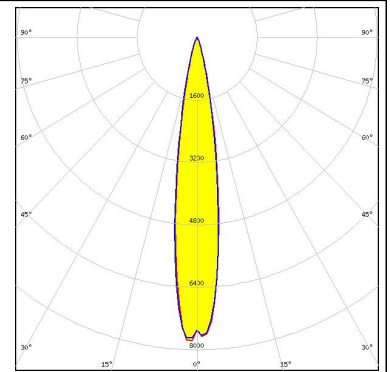

LED XP-E2  
 FWHM 14.3°  
 Efficiency 89 %  
 Peak intensity 9.4 cd/lm  
 LEDs/each optic 1  
 Light colour White  
 Required components:

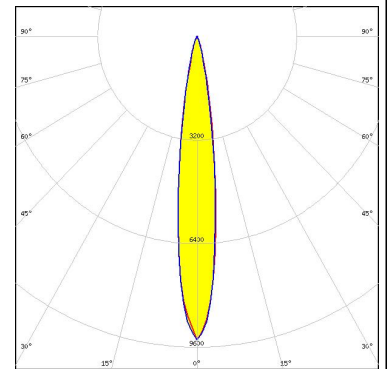

LED XP-G2  
 FWHM 20.0°  
 Efficiency 89 %  
 Peak intensity 5.3 cd/lm  
 LEDs/each optic 1  
 Light colour White  
 Required components:

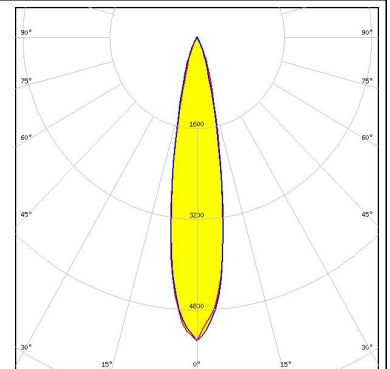

LED XP-G2 HE  
 FWHM 27.0°  
 Efficiency 86 %  
 Peak intensity 2.8 cd/lm  
 LEDs/each optic 1  
 Light colour White  
 Required components:

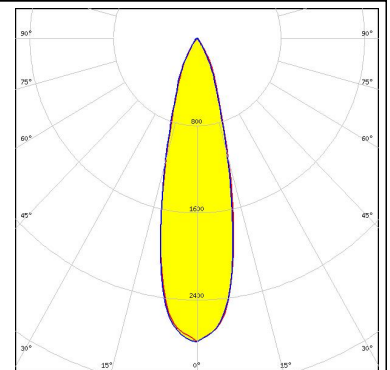

#### PHOTOMETRIC DATA (SIMULATED):



LED XP-G3  
 FWHM 26.0°  
 Efficiency 86 %  
 Peak intensity 3.1 cd/lm  
 LEDs/each optic 1  
 Light colour White  
 Required components:

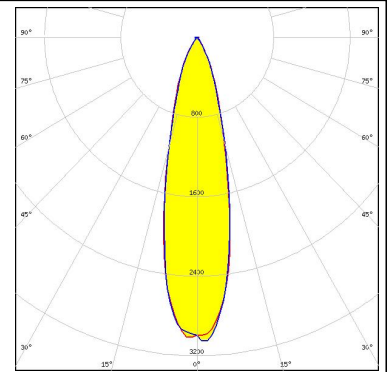

LED XQ-E HI  
 FWHM 18.0°  
 Efficiency 82 %  
 Peak intensity 6.4 cd/lm  
 LEDs/each optic 1  
 Light colour White  
 Required components:

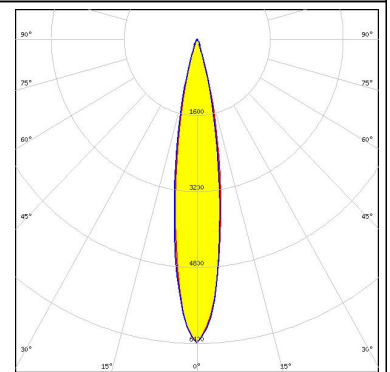

LED LUXEON 2835 Line  
 FWHM 16.0°  
 Efficiency 89 %  
 Peak intensity 7 cd/lm  
 LEDs/each optic 1  
 Light colour White  
 Required components:

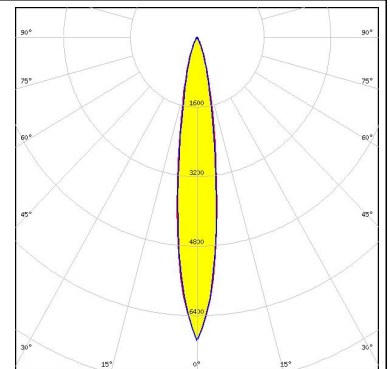

LED LUXEON CZ  
 FWHM 12.0°  
 Efficiency 90 %  
 Peak intensity 13.5 cd/lm  
 LEDs/each optic 1  
 Light colour White  
 Required components:

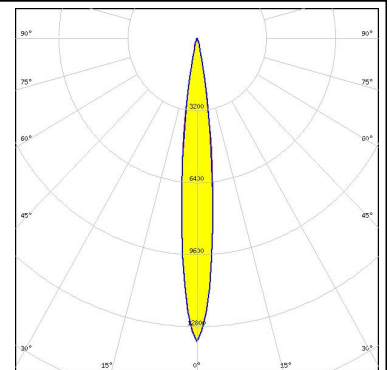

#### PHOTOMETRIC DATA (SIMULATED):

##### LUMILEDS

LED LUXEON V2  
 FWHM 22.0°  
 Efficiency 90 %  
 Peak intensity 3.8 cd/lm  
 LEDs/each optic 1  
 Light colour White  
 Required components:

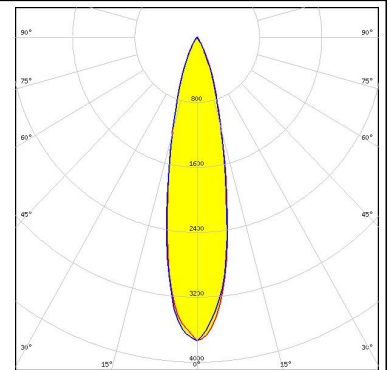

##### LUMILEDS

LED LUXEON Z  
 FWHM 12.0°  
 Efficiency 87 %  
 Peak intensity 13.2 cd/lm  
 LEDs/each optic 1  
 Light colour White  
 Required components:

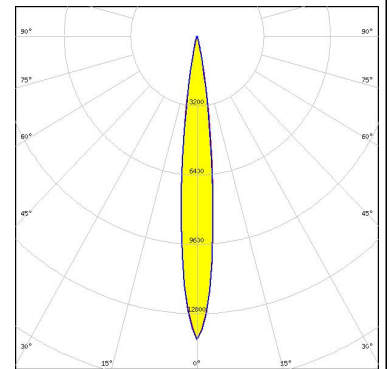

##### LUMILEDS

LED LUXEON Z ES  
 FWHM 15.0°  
 Efficiency 88 %  
 Peak intensity 9 cd/lm  
 LEDs/each optic 1  
 Light colour White  
 Required components:

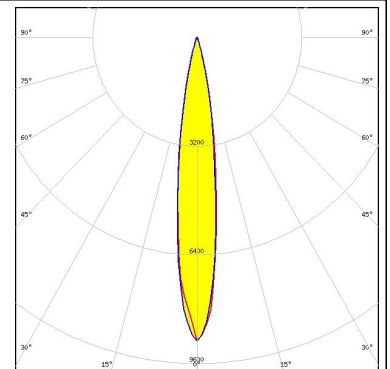

##### LUMINUS

LED SST-20  
 FWHM 20.0°  
 Efficiency 86 %  
 Peak intensity 5.2 cd/lm  
 LEDs/each optic 1  
 Light colour White  
 Required components:

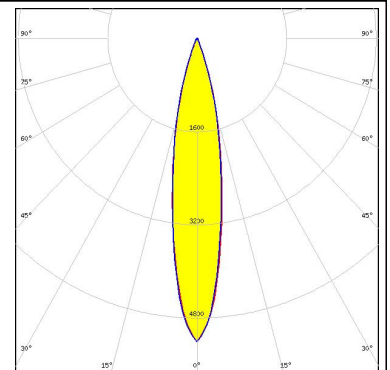

#### PHOTOMETRIC DATA (SIMULATED):

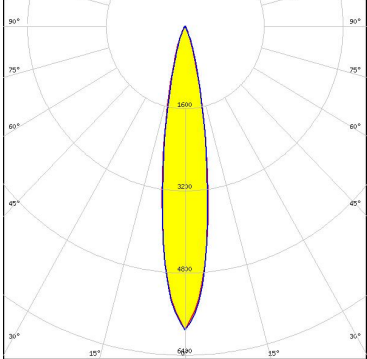
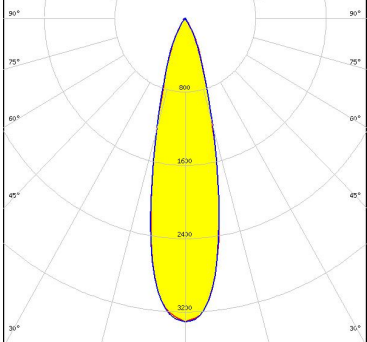
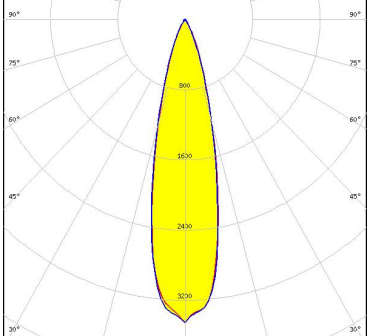
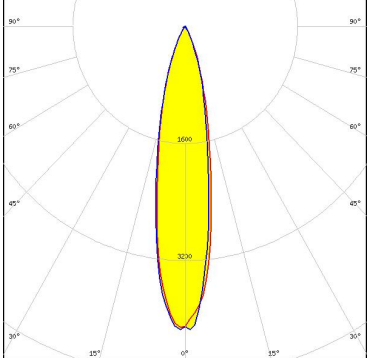
<p><b>NICHIA</b></p> <p>LED: NCSxx19B            FWHM: 18.0°            Efficiency: 84 %            Peak intensity: 5.9 cd/lm            LEDs/each optic: 1            Light colour: White            Required components:</p>	
<p><b>NICHIA</b></p> <p>LED: NVSW219F            FWHM: 26.0°            Efficiency: 88 %            Peak intensity: 3.3 cd/lm            LEDs/each optic: 1            Light colour: White            Required components:</p>	
<p><b>NICHIA</b></p> <p>LED: NVSxx19B/NVSxx19C            FWHM: 25.0°            Efficiency: 85 %            Peak intensity: 3.5 cd/lm            LEDs/each optic: 1            Light colour: White            Required components:</p>	
<p><b>OSRAM</b>  <small>Opto Semiconductors</small></p> <p>LED: Duris S5 (2 chip)            FWHM: 20.0°            Efficiency: 87 %            Peak intensity: 7.1 cd/lm            LEDs/each optic: 1            Light colour: White            Required components:</p>	

#### PHOTOMETRIC DATA (SIMULATED):

##### OSRAM Opto Semiconductors

LED Duris S5 (Single chip)  
 FWHM 20.0°  
 Efficiency 86 %  
 Peak intensity 4.5 cd/lm  
 LEDs/each optic 1  
 Light colour White  
 Required components:

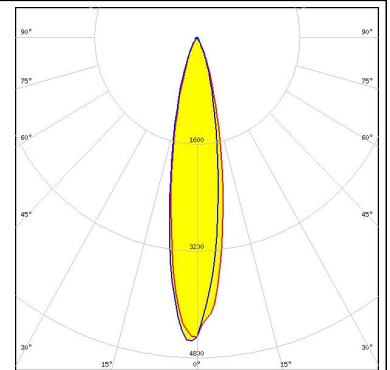

##### OSRAM Opto Semiconductors

LED OSCONIQ P 3030  
 FWHM 14.0°  
 Efficiency 86 %  
 Peak intensity 8.5 cd/lm  
 LEDs/each optic 1  
 Light colour White  
 Required components:

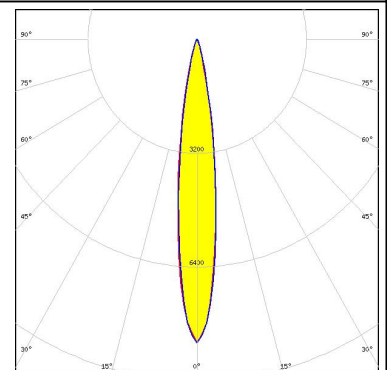

##### OSRAM Opto Semiconductors

LED OSCONIQ P 3737 (2W version)  
 FWHM 20.0°  
 Efficiency 88 %  
 Peak intensity 5.1 cd/lm  
 LEDs/each optic 1  
 Light colour White  
 Required components:

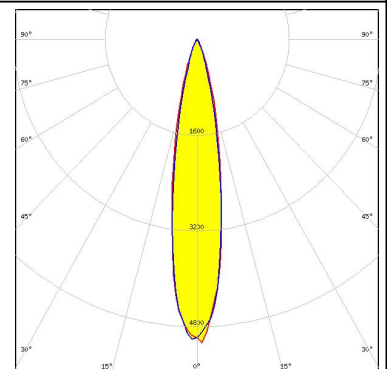

##### OSRAM Opto Semiconductors

LED OSLOM SSL 150  
 FWHM 14.5°  
 Efficiency 88 %  
 Peak intensity 8.7 cd/lm  
 LEDs/each optic 1  
 Light colour White  
 Required components:

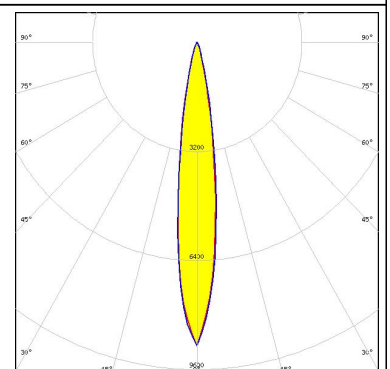



#### PHOTOMETRIC DATA (SIMULATED):

#### OSRAM

Opto Semiconductors

LED OSLOM SSL 80  
 FWHM 15.0°  
 Efficiency 87 %  
 Peak intensity 7.6 cd/lm  
 LEDs/each optic 1  
 Light colour White  
 Required components:

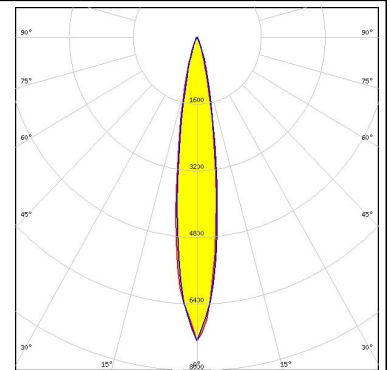

#### OSRAM

Opto Semiconductors

LED SFH 4715AS  
 FWHM 22.0°  
 Efficiency 86 %  
 LEDs/each optic 1  
 Light colour IR  
 Required components:

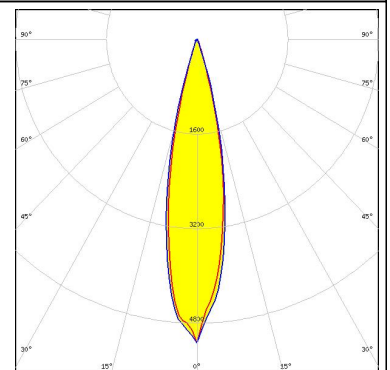

#### OSRAM

Opto Semiconductors

LED SFH 4716AS  
 FWHM 17.0°  
 Efficiency 87 %  
 LEDs/each optic 1  
 Light colour IR  
 Required components:

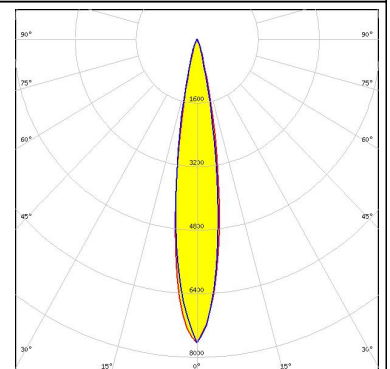

#### SAMSUNG

LED LH351B  
 FWHM 26.0°  
 Efficiency 88 %  
 Peak intensity 3.5 cd/lm  
 LEDs/each optic 1  
 Light colour White  
 Required components:

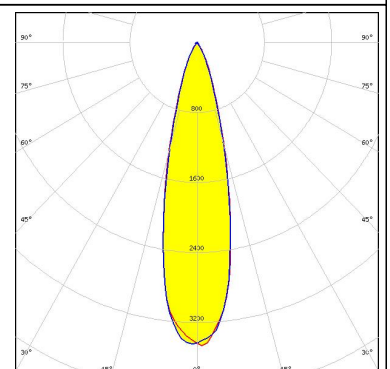

#### PHOTOMETRIC DATA (SIMULATED):

### SAMSUNG

LED LM301A  
FWHM 14.5°  
Efficiency 87 %  
Peak intensity 7.1 cd/lm  
LEDs/each optic 1  
Light colour White  
Required components:

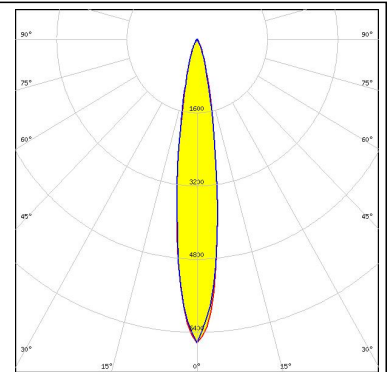

### SAMSUNG

LED LM302A  
FWHM 16.0°  
Efficiency 87 %  
Peak intensity 5.3 cd/lm  
LEDs/each optic 1  
Light colour White  
Required components:

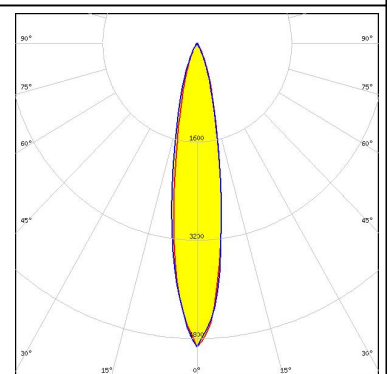

### GENERAL INFORMATION:

NOTE: The typical beam angle will be changed by different color, chip size and chip position tolerance. The typical total beam angle is the full angle measured where the luminous intensity is half of the peak value.

### MATERIALS:

As part of our continuous research and improvement processes, and to ensure the best possible quality and availability of our products, LEDiL reserves the right to change material grades without notice.

### PRODUCT DATA USER AGREEMENT AND DISCLAIMER:

The measured data in the provided downloadable LEDiL Product Datasheets and Mechanical 2D-Drawings is rounded and provided as reference for planning. LEDiL Oy's optical specifications have been verified by conducting performance testing of the products in accordance with the company's quality system. The reported data are averaged results of multiple measurements with typical variation. LEDiL Oy reserves the right to without prior notification make changes and improvements to its products.

LEDiL Oy assumes neither warranty, nor guarantee nor any other liability of any kind for the contents and correctness of the provided data. The provided data has been generated with highest diligence but the provided data may in reality not represent the complete possible variation range of all intrinsic parameters. Therefore, in certain cases a deviation from the provided data could occur.

LEDiL Oy reserves the right to undertake technical changes of its products without further notification which could lead to changes in the provided data. LEDiL Oy assumes no liability of any kind for the possible deviation from any provided data or any other damage resulting from the usage of the provided data.

The user agrees to this disclaimer and user agreement with the download or usage of the provided files.

#### LEDiL Oy

Joensuunkatu 13  
FI-24240 SALO  
Finland

#### LEDiL Inc.

228 West Page Street  
Suite D  
Sycamore IL 60178  
USA

#### Local sales and technical support

[www.ledil.com/  
where\\_to\\_buy](http://www.ledil.com/where_to_buy)

#### Shipping locations

Salo, Finland  
Hong Kong, China

#### Distribution Partners

[www.ledil.com/  
where\\_to\\_buy](http://www.ledil.com/where_to_buy)

# Mouser Electronics

Authorized Distributor

Click to View Pricing, Inventory, Delivery & Lifecycle Information:

Ledil:

[FP16558\\_LISA3-RS-PIN](#)