

GABRIELLA-45-W

~35° wide beam with holder

SPECIFICATION:

Dimensions	Ø 45.0 mm
Height	28.8 mm
Fastening	pin, screw
ROHS compliant	yes ⓘ

MATERIALS:

Component	Type	Material	Colour	Finish	Length (mm)
C15813_GABRIELLA-45-W	Single lens	PMMA	clear		
C15528_GABRIELLA-45-HLD	Holder	PC	black		



ORDERING INFORMATION:

Quantities for one set:

Single lens	1
Holder	1

Component		Qty in box	MOQ	MPQ	Box weight (kg)
C15813_GABRIELLA-45-W	Single lens	405	90	45	8.6
» Box size: 476 x 273 x 292 mm					
C15528_GABRIELLA-45-HLD	Holder	405	90	45	5.1
» Box size: 476 x 273 x 292 mm					

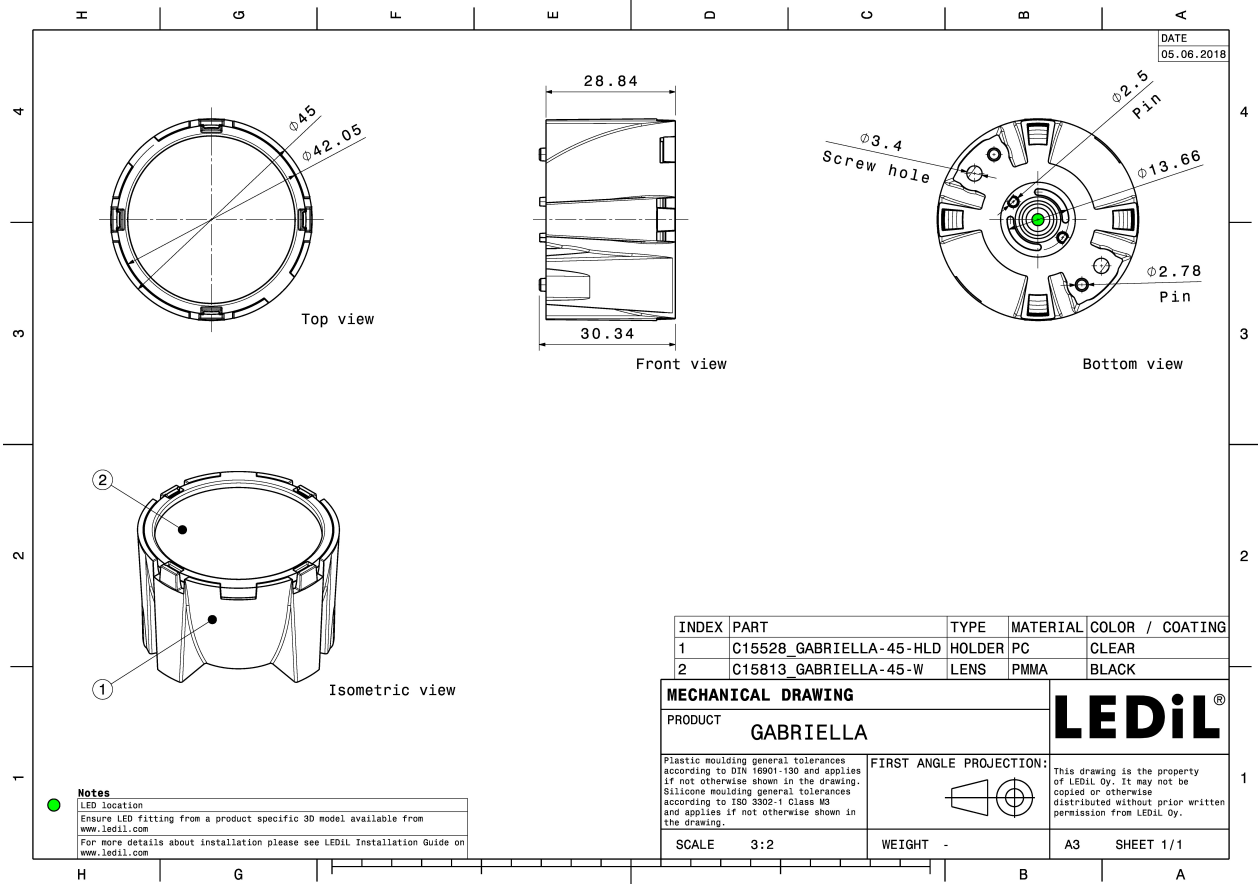

See also our general installation guide: www.ledil.com/installation_guide

OPTICAL RESULTS (MEASURED):



LED XM-L RGBW (XMLCTW)
FWHM / FWTM 37.0° / 62.0°
Efficiency 79 %
Peak intensity 1.8 cd/lm
LEDs/each optic 1
Light colour/type White
Required components:

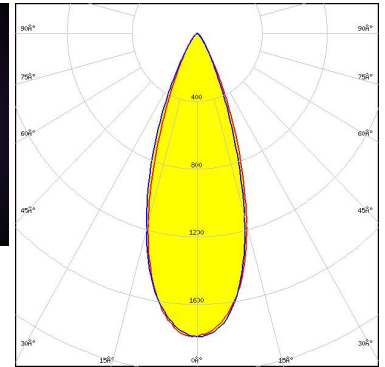
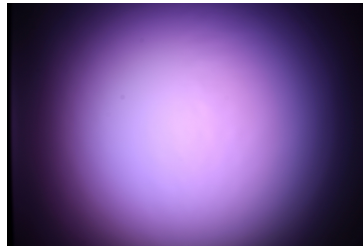

Light distribution files



LED LUXEON 5052 RGBW
FWHM / FWTM 32.0° / 57.0°
Efficiency 79 %
Peak intensity 2.2 cd/lm
LEDs/each optic 1
Light colour/type RGBW
Required components:

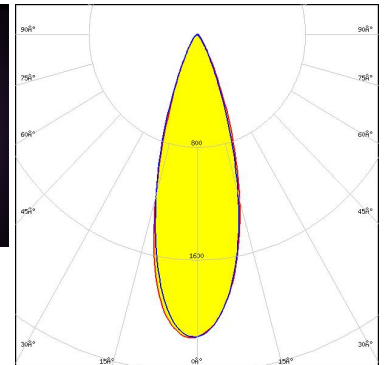
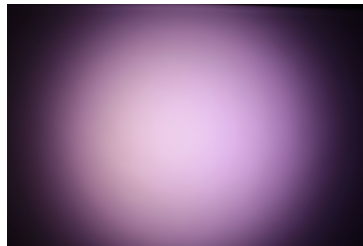

Light distribution files



LED LUXEON CZ
FWHM / FWTM 31.0° / 56.0°
Efficiency 78 %
Peak intensity 2.2 cd/lm
LEDs/each optic 4
Light colour/type RGBW
Required components:

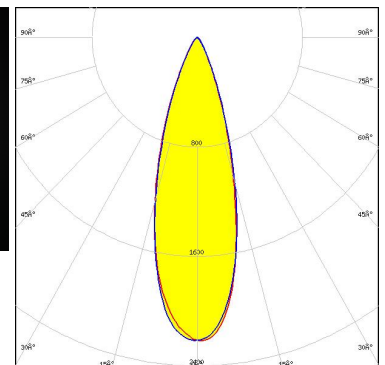
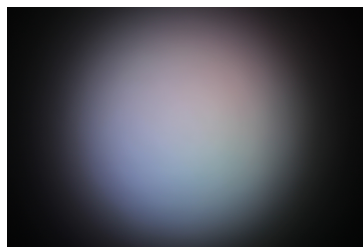

Light distribution files

OPTICAL RESULTS (MEASURED):



LED SBM-40-RGBW
FWHM / FWTM 33.0° / 56.0°
Efficiency 80 %
Peak intensity 2.1 cd/lm
LEDs/each optic 1
Light colour/type White
Required components:

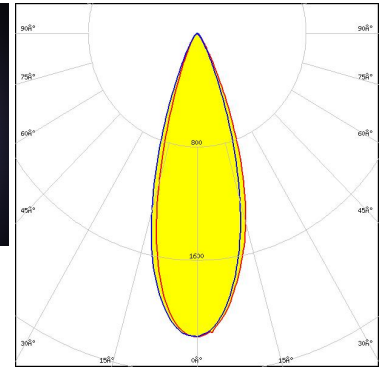
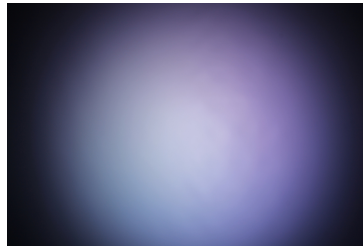

Light distribution files



LED NCSxE17A
FWHM / FWTM 31.0° / 54.0°
Efficiency 81 %
Peak intensity 2.4 cd/lm
LEDs/each optic 4
Light colour/type RGBW
Required components:

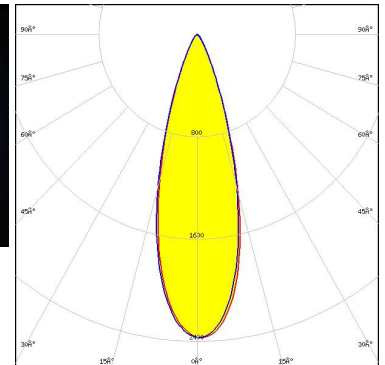
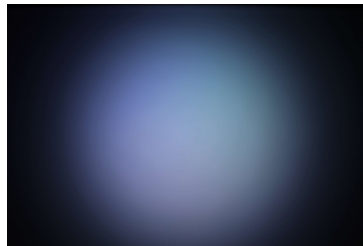

Light distribution files



LED NVSW219F
FWHM / FWTM 35.0° / 59.0°
Efficiency 80 %
Peak intensity 2 cd/lm
LEDs/each optic 1
Light colour/type White
Required components:

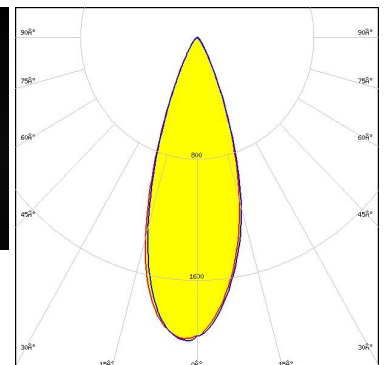
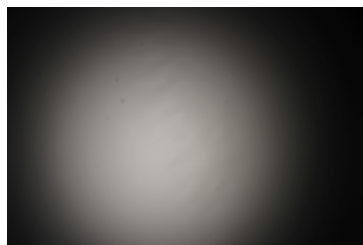

Light distribution files

OPTICAL RESULTS (MEASURED):

OSRAM
Opto Semiconductors

LED OSLON Square EC
FWHM / FWTM 34.0° / 57.0°
Efficiency 78 %
Peak intensity 2 cd/lm
LEDs/each optic 1
Light colour/type White
Required components:

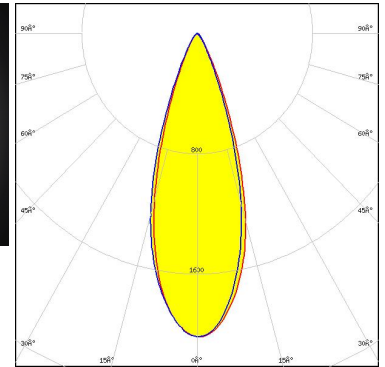
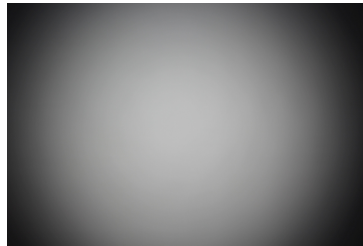

Light distribution files

OSRAM
Opto Semiconductors

LED Ostar-SMT RGB
FWHM / FWTM 34.0° / 56.0°
Efficiency 81 %
Peak intensity 2.2 cd/lm
LEDs/each optic 1
Light colour/type White
Required components:

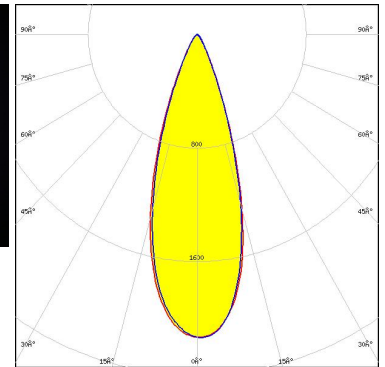
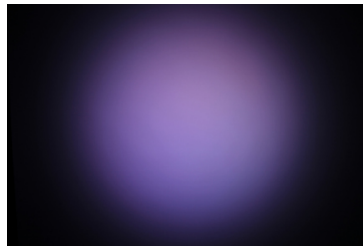

Light distribution files

SEUL
SEOUL SEMICONDUCTOR

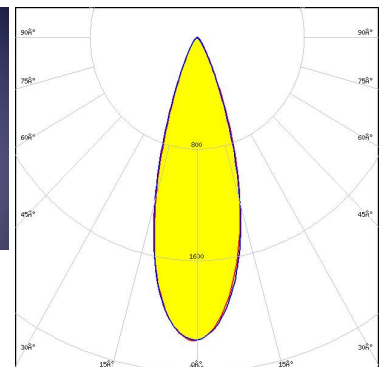
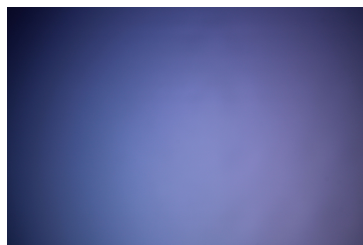

LED SPF05F0A
FWHM / FWTM 33.0° / 56.0°
Efficiency 78 %
Peak intensity 2.2 cd/lm
LEDs/each optic 1
Light colour/type RGBW
Required components:

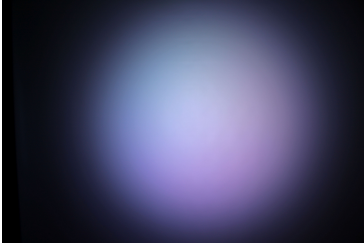
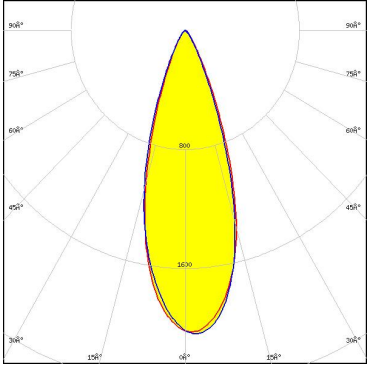

Light distribution files

OPTICAL RESULTS (MEASURED):

 <small>SEOUL SEMICONDUCTOR</small>			
LED	SPF05F0B		
FWHM / FWTM	34.0° / 58.0°		
Efficiency	80 %		
Peak intensity	2.1 cd/lm		
LEDs/each optic	1		
Light colour/type	RGBW		
Required components:		<p>Light distribution files</p>	

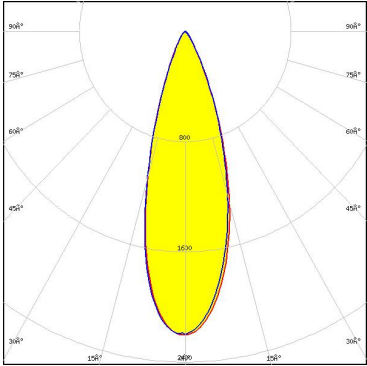
 <small>SEOUL SEMICONDUCTOR</small>			
LED	SPF05F0C		
FWHM / FWTM	32.0° / 56.0°		
Efficiency	79 %		
Peak intensity	2.2 cd/lm		
LEDs/each optic	1		
Light colour/type	RGBW		
Required components:		<p>Light distribution files</p>	

OPTICAL RESULTS (SIMULATED):



LED CLQ6A-TKW
 FWHM / FWTM 40.0° / 64.0°
 Efficiency 90 %
 Peak intensity 2 cd/lm
 LEDs/each optic 1
 Light colour/type RGBW
 Required components:

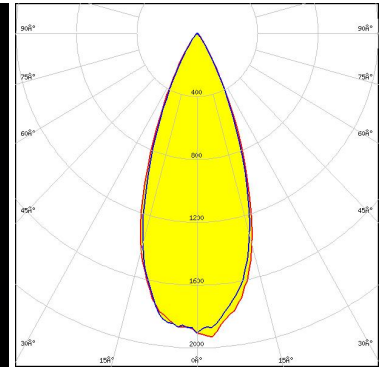
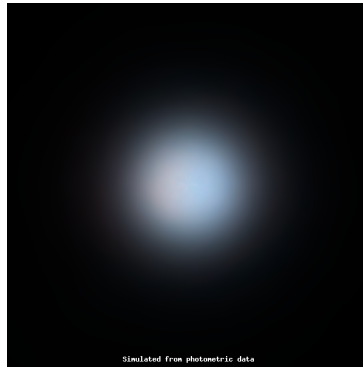

Light distribution files



LED J Series 5050 Round LES
 FWHM / FWTM 33.0° / 54.0°
 Efficiency 90 %
 Peak intensity 2.7 cd/lm
 LEDs/each optic 1
 Light colour/type White
 Required components:

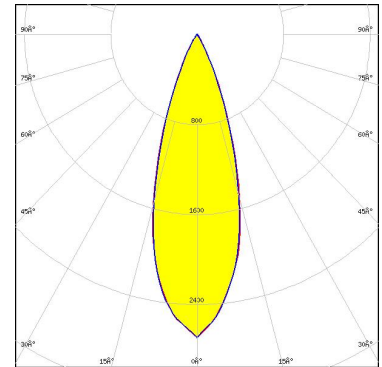

Light distribution files



LED XE-G
 FWHM / FWTM 40.0° / 62.0°
 Efficiency 91 %
 Peak intensity 2 cd/lm
 LEDs/each optic 4
 Light colour/type RGBW
 Required components:

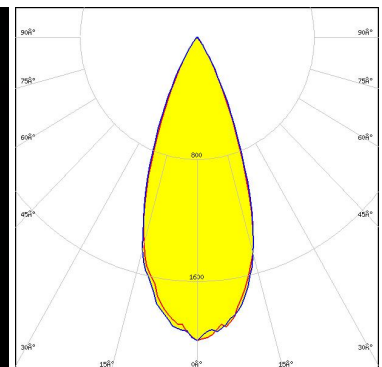
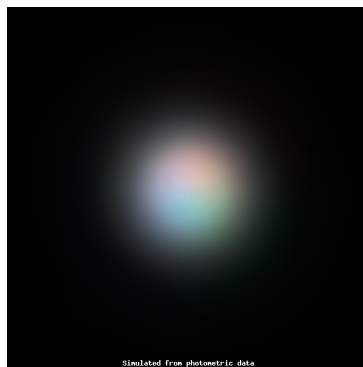

Light distribution files

OPTICAL RESULTS (SIMULATED):



LED XHP50.2
FWHM / FWTM 36.0° / 60.0°
Efficiency 87 %
Peak intensity 2.2 cd/lm
LEDs/each optic 1
Light colour/type White
Required components:

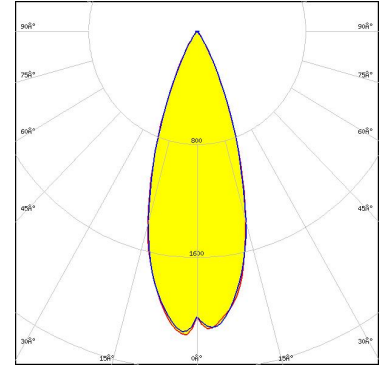

Light distribution files



LED XHP70.2
FWHM / FWTM 35.0° / 62.0°
Efficiency 85 %
Peak intensity 2.1 cd/lm
LEDs/each optic 1
Light colour/type White
Required components:

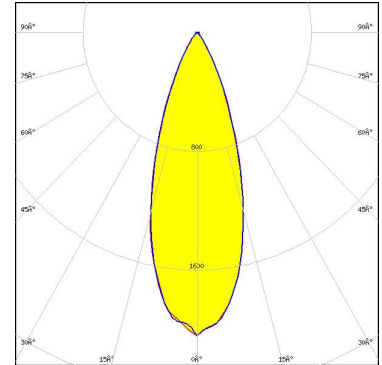

Light distribution files



LED XM-L RGBW (XMLDCL HD)
FWHM / FWTM 43.0° / 67.0°
Efficiency 90 %
Peak intensity 1.8 cd/lm
LEDs/each optic 1
Light colour/type RGBW
Required components:

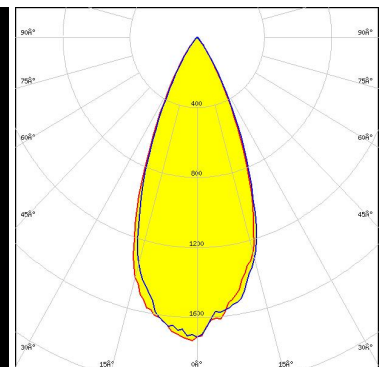
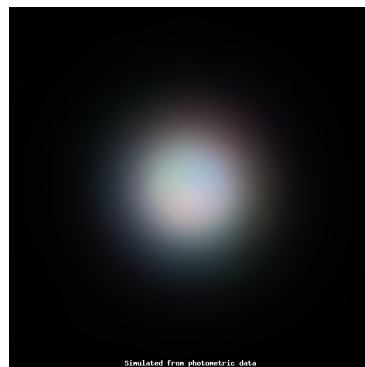

Light distribution files

OPTICAL RESULTS (SIMULATED):



LED XM-L RGBW (XMLDCL HI)
 FWHM / FWTM 39.0° / 61.0 + 62.0°
 Efficiency 91 %
 Peak intensity 2.2 cd/lm
 LEDs/each optic 1
 Light colour/type RGBW
 Required components:

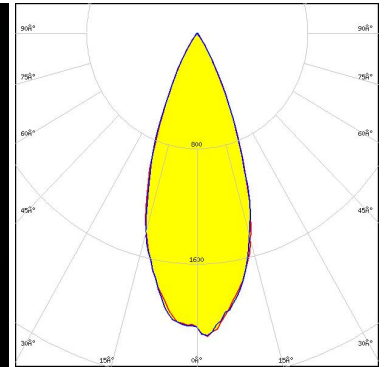
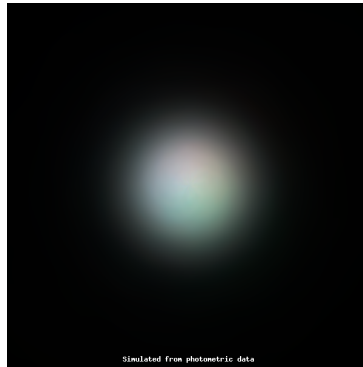

Light distribution files



LED XP-L RGBW HD
 FWHM / FWTM 40.0° / 62.0°
 Efficiency 90 %
 Peak intensity 2 cd/lm
 LEDs/each optic 1
 Light colour/type RGBW
 Required components:

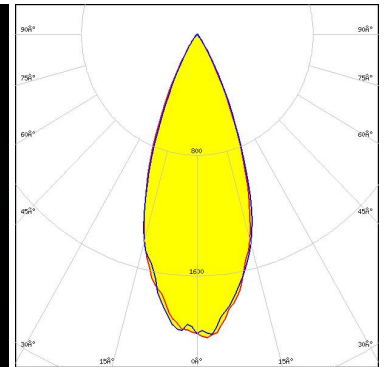
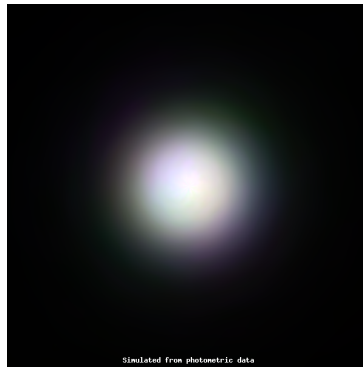

Light distribution files



LED XP-L RGBW HI
 FWHM / FWTM 39.0° / 62.0 + 61.0°
 Efficiency 90 %
 Peak intensity 2.2 cd/lm
 LEDs/each optic 1
 Light colour/type RGBW
 Required components:

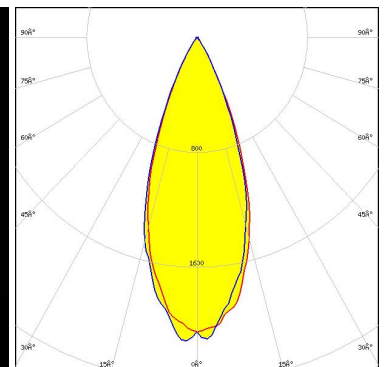
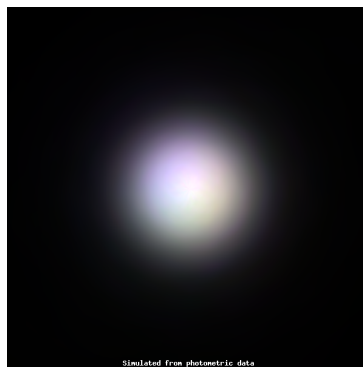

Light distribution files

OPTICAL RESULTS (SIMULATED):

LED ENGIN

LED LZ7 Plus (LZ7-04M2PD)
 FWHM / FWTM 34.0° / 54.0°
 Efficiency 90 %
 Peak intensity 2.7 cd/lm
 LEDs/each optic 1
 Light colour/type White
 Required components:

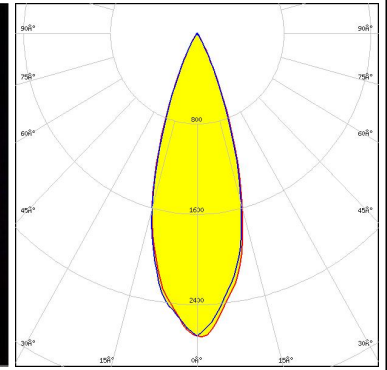
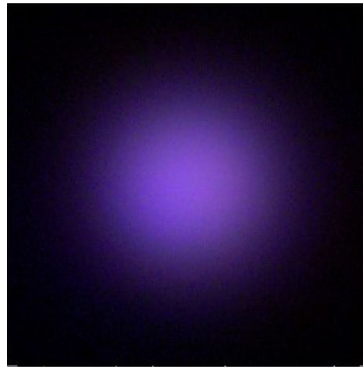

Light distribution files

LUMILEDS

LED LUXEON 7070
 FWHM / FWTM 32.0° / 58.0°
 Efficiency 87 %
 Peak intensity 2.5 cd/lm
 LEDs/each optic 1
 Light colour/type White
 Required components:

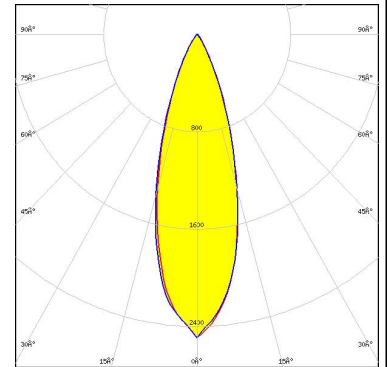

Light distribution files

LUMILEDS

LED LUXEON Rubix
 FWHM / FWTM 39.0 + 40.0° / 62.0°
 Efficiency 91 %
 Peak intensity 2.1 cd/lm
 LEDs/each optic 4
 Light colour/type RGBW
 Required components:

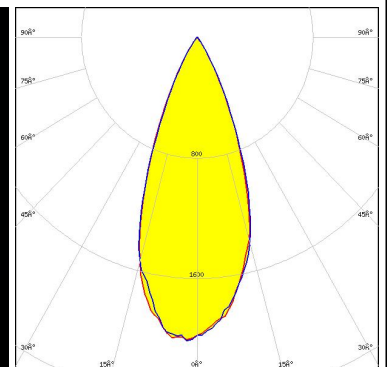
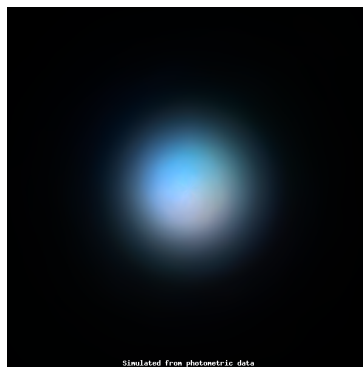

Light distribution files

OPTICAL RESULTS (SIMULATED):

OSRAM
Opto Semiconductors

LED DURIS E 5050 (GW J9LHS1.4M)
FWHM / FWTM 39.0 + 40.0° / 62.0 + 64.0°
Efficiency 90 %
Peak intensity 2 cd/lm
LEDs/each optic 1
Light colour/type RGBW
Required components:

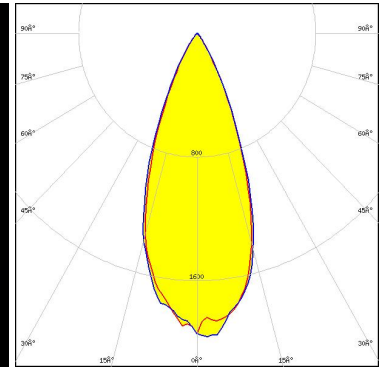

Light distribution files

OSRAM
Opto Semiconductors

LED DURIS E 5050 (GW J9LHS2.4M)
FWHM / FWTM 38.0 + 40.0° / 62.0 + 63.0°
Efficiency 90 %
Peak intensity 2 cd/lm
LEDs/each optic 1
Light colour/type RGBW
Required components:

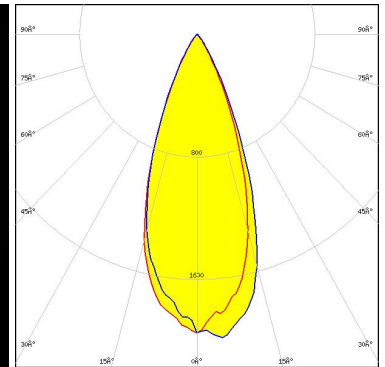

Light distribution files

OSRAM
Opto Semiconductors

LED OSOLON Pure 1414
FWHM / FWTM 39.0 + 36.0° / 60.0 + 59.0°
Efficiency 91 %
Peak intensity 2.4 cd/lm
LEDs/each optic 4
Light colour/type RGBW
Required components:

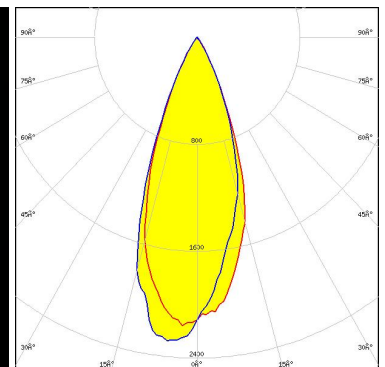
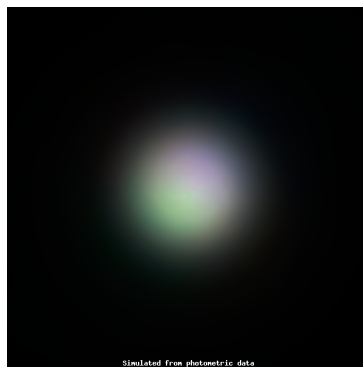

Light distribution files

OPTICAL RESULTS (SIMULATED):

OSRAM
Opto Semiconductors

LED SFH 4717AS
FWHM / FWTM 32.0° / 52.0°
Efficiency 88 %
LEDs/each optic 1
Light colour/type IR
Required components:

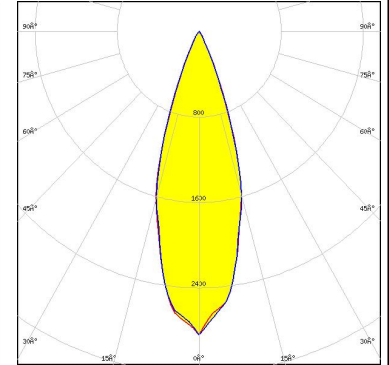
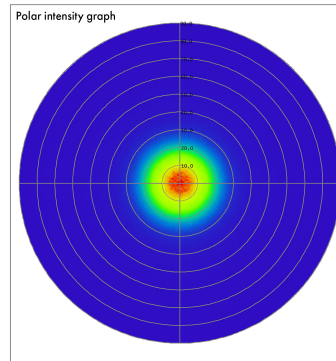

Light distribution files

GENERAL INFORMATION:

NOTE: The typical beam angle will be changed by different color, chip size and chip position tolerance. The typical total beam angle is the full angle measured where the luminous intensity is half of the peak value.

MATERIALS:

As part of our continuous research and improvement processes, and to ensure the best possible quality and availability of our products, LEDiL reserves the right to change material grades without notice.

PRODUCT DATA USER AGREEMENT AND DISCLAIMER:

The measured data in the provided downloadable LEDiL Product Datasheets and Mechanical 2D-Drawings is rounded and provided as reference for planning. LEDiL Oy's optical specifications have been verified by conducting performance testing of the products in accordance with the company's quality system. The reported data are averaged results of multiple measurements with typical variation. LEDiL Oy reserves the right to without prior notification make changes and improvements to its products.

LEDiL Oy assumes neither warranty, nor guarantee nor any other liability of any kind for the contents and correctness of the provided data. The provided data has been generated with highest diligence but the provided data may in reality not represent the complete possible variation range of all intrinsic parameters. Therefore, in certain cases a deviation from the provided data could occur.

LEDiL Oy reserves the right to undertake technical changes of its products without further notification which could lead to changes in the provided data. LEDiL Oy assumes no liability of any kind for the possible deviation from any provided data or any other damage resulting from the usage of the provided data.

The user agrees to this disclaimer and user agreement with the download or usage of the provided files.

LEDiL Oy

Joensuunkatu 13
FI-24240 SALO
Finland

LEDiL Inc.

228 West Page Street
Suite D
Sycamore IL 60178
USA

Ledil Optics Technology (Shenzhen) Co., Ltd.

405 , Block B
Casic Motor Building
Shenzhen 518057
P.R.CHINA

Local sales and technical support

[www.ledil.com/
where_to_buy](http://www.ledil.com/where_to_buy)

Shipping locations

Poznan, Poland
Hong Kong, China

Distribution Partners

[www.ledil.com/
where_to_buy](http://www.ledil.com/where_to_buy)

Mouser Electronics

Authorized Distributor

Click to View Pricing, Inventory, Delivery & Lifecycle Information:

[Ledil:](#)

[CN15816_GABRIELLA-45-W](#)