

IRIS

~5° real spot beam optimized for CREE XP-E.
Assembly with holder and installation tape.

TECHNICAL SPECIFICATIONS:

Dimensions	Ø 38.0 mm
Height	27.1 mm
Fastening	glue, tape, pin, screw
ROHS compliant	yes ⓘ

MATERIAL SPECIFICATIONS:

Component	Type	Material	Colour	Finish
IRIS	Single lens	PMMA	clear	
IRIS-XP-HLD-TAPE	Assembly	PC	black	

ORDERING INFORMATION:

Component		Qty in box	MOQ	MPQ	Box weight (kg)
FCA12077_IRIS	Single lens	378	126	42	8.9
» Box size: 480 x 280 x 300 mm					



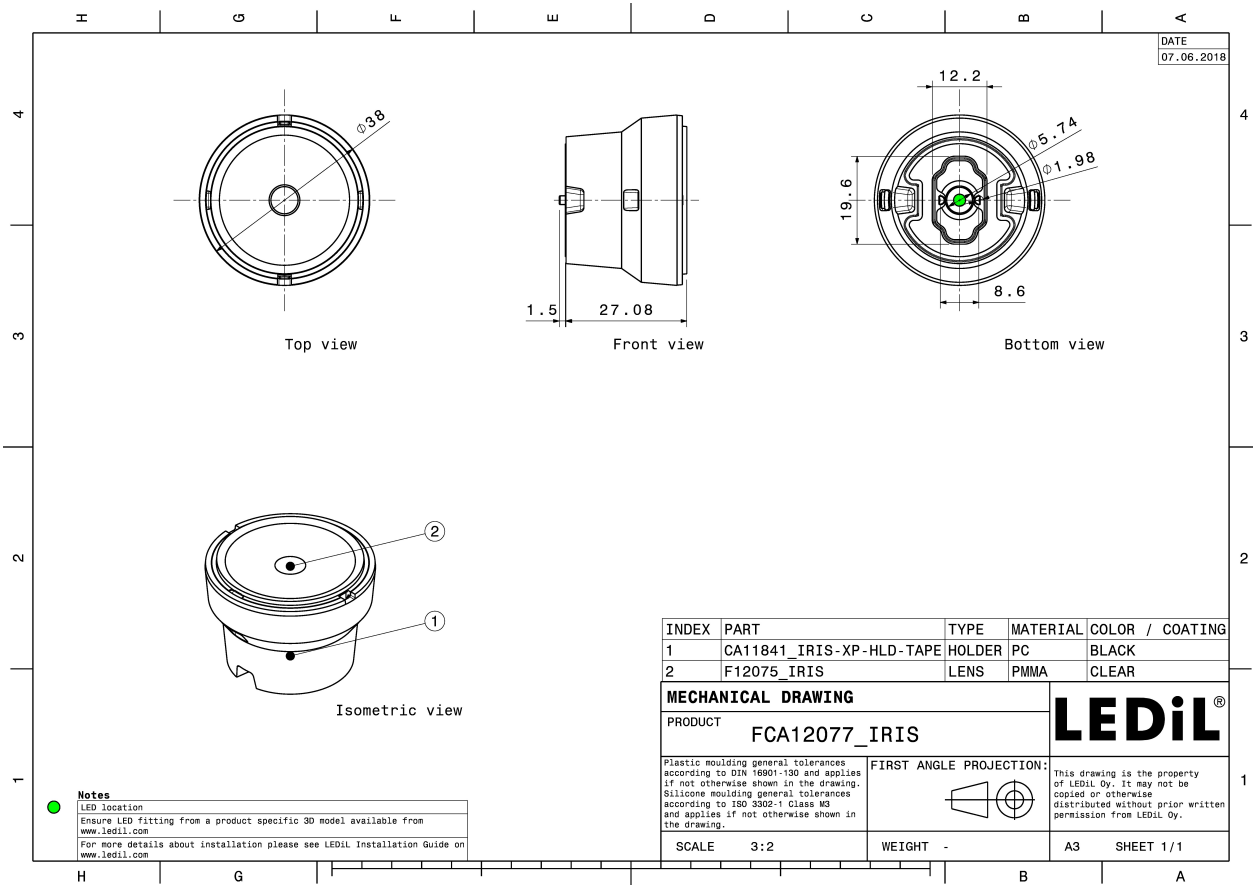

PHOTOMETRIC DATA (MEASURED):

CREE 

LED XHP35 HD
FWHM 10.0°
Efficiency 89 %
Peak intensity 18.6 cd/Im
LEDs/each optic 1
Light colour White
Required components:

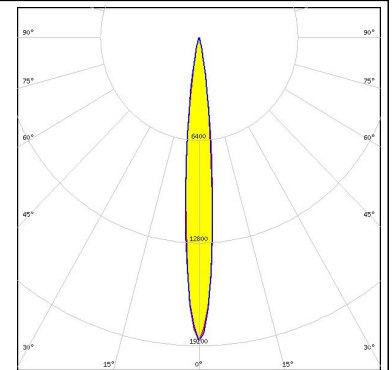
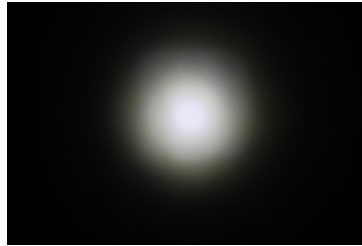

CREE 

LED XHP35 HI
FWHM 7.6°
Efficiency 90 %
Peak intensity 35.9 cd/Im
LEDs/each optic 1
Light colour White
Required components:

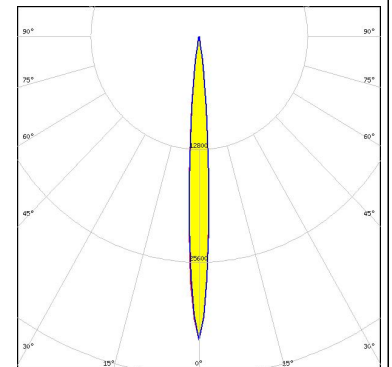

CREE 

LED XP-E
FWHM 4.0°
Efficiency 93 %
Peak intensity 87.4 cd/Im
LEDs/each optic 1
Light colour White
Required components:

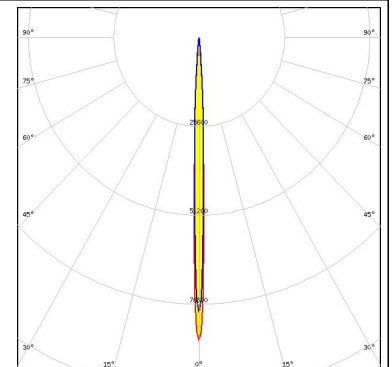

CREE 

LED XP-E2
FWHM 5.0°
Efficiency 93 %
Peak intensity 103.9 cd/Im
LEDs/each optic 1
Light colour White
Required components:

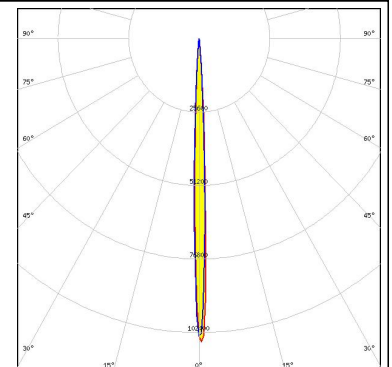

PHOTOMETRIC DATA (MEASURED):



LED XP-G
 FWHM 6.0°
 Efficiency 94 %
 Peak intensity 46.4 cd/lm
 LEDs/each optic 1
 Light colour White
 Required components:

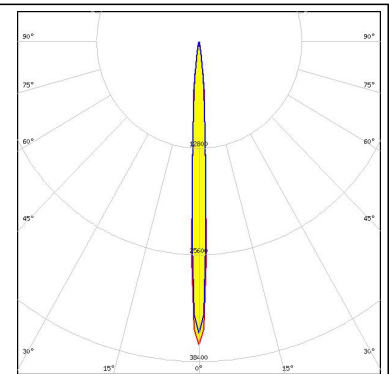
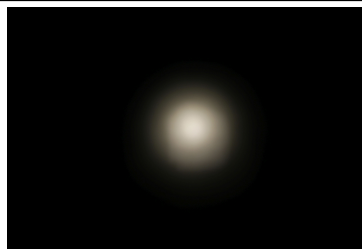

LED XP-G2
 FWHM 6.0°
 Efficiency 95 %
 Peak intensity 46 cd/lm
 LEDs/each optic 1
 Light colour White
 Required components:

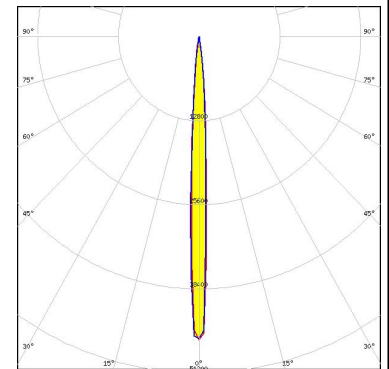

LED XQ-E HI
 FWHM 3.9°
 Efficiency 88 %
 Peak intensity 123.3 cd/lm
 LEDs/each optic 1
 Light colour White
 Required components:

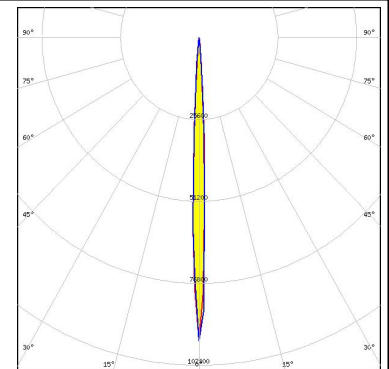

LED H35C1 (LEMWA33)
 FWHM 8.0°
 Efficiency 89 %
 Peak intensity 40.4 cd/lm
 LEDs/each optic 1
 Light colour White
 Required components:

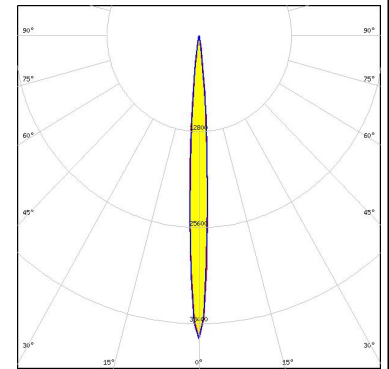

PHOTOMETRIC DATA (MEASURED):

LUMILEDS

LED LUXEON Rebel
 FWHM 5.0°
 Efficiency %
 Peak intensity 75.6 cd/Im
 LEDs/each optic 1
 Light colour White
 Required components:

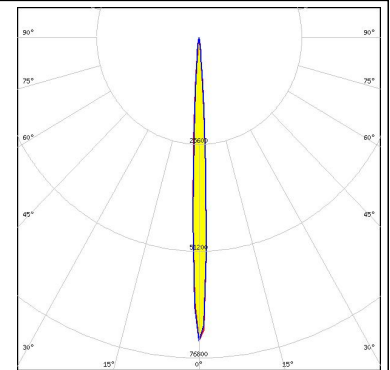

LUMILEDS

LED LUXEON Rebel ES
 FWHM 7.0°
 Efficiency 93 %
 Peak intensity 38.5 cd/Im
 LEDs/each optic 1
 Light colour White
 Required components:

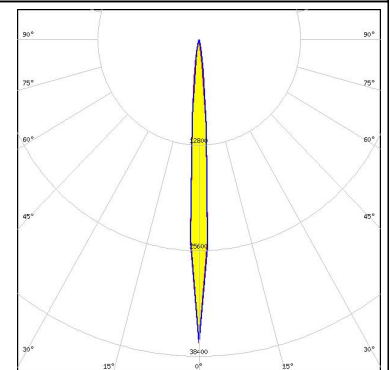

LUMILEDS

LED LUXEON T
 FWHM 7.0°
 Efficiency 94 %
 Peak intensity 40.2 cd/Im
 LEDs/each optic 1
 Light colour White
 Required components:

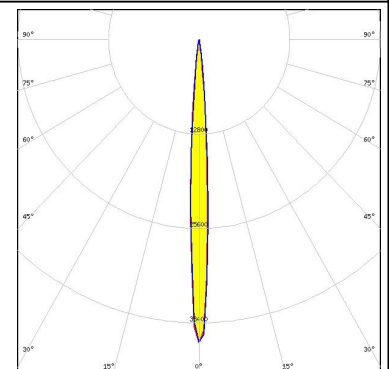

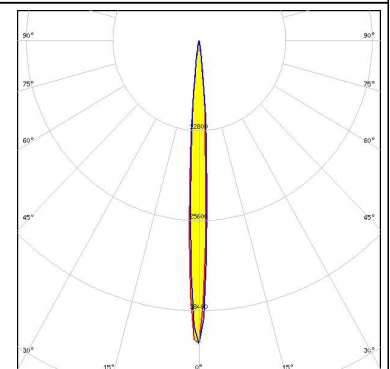

LUMILEDS

LED LUXEON TX
 FWHM 6.9°
 Efficiency 89 %
 Peak intensity 43.1 cd/Im
 LEDs/each optic 1
 Light colour White
 Required components:

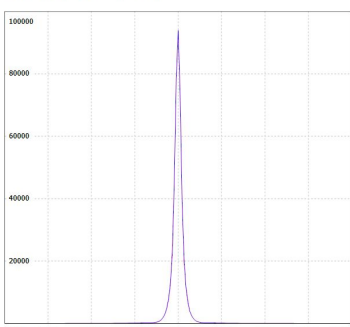
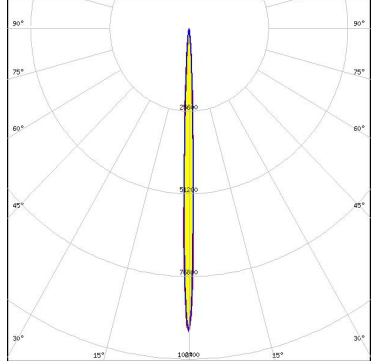
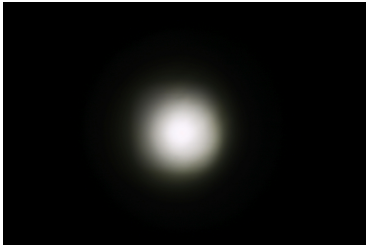
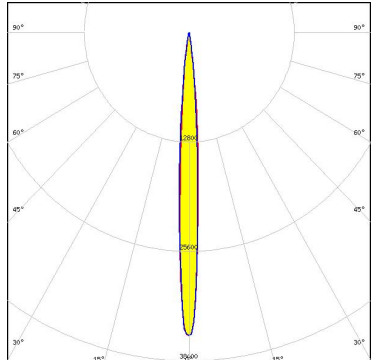

PHOTOMETRIC DATA (MEASURED):

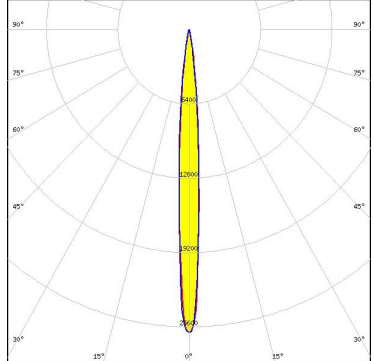
<p>LUMILEDS</p> <p>LED LUXEON Z ES FWHM 4.0° Efficiency 93 % Peak intensity 94.1 cd/lm LEDs/each optic 1 Light colour White Required components:</p>	<p>Luminaire: LEDiL Oy FCA12077_IRIS (2 ES) Lamps: 1 x Philips Lumileds Luxeon Z ES (8X22-6070) 84.6528mm@250mA, P=0.730483W, I=249.9mA</p>  <p>cd/lm C0 - C180 C90 - C270 η = 93%</p>	
<p>NICHIA</p> <p>LED NCSxx19A FWHM 5.0° Efficiency % LEDs/each optic 1 Light colour White Required components:</p>		
<p>NICHIA</p> <p>LED NVSW219F FWHM 7.0° Efficiency 94 % Peak intensity 35.7 cd/lm LEDs/each optic 1 Light colour White Required components:</p>		
<p>NICHIA</p> <p>LED NVSW3x9A FWHM 8.0° Efficiency 89 % Peak intensity 26.3 cd/lm LEDs/each optic 1 Light colour White Required components:</p>		

PHOTOMETRIC DATA (MEASURED):



LED NVSxx19A
 FWHM 6.0°
 Efficiency 93 %
 Peak intensity 38.7 cd/lm
 LEDs/each optic 1
 Light colour White
 Required components:



LED NVSxx19B/NVSxx19C
 FWHM 7.0°
 Efficiency 92 %
 Peak intensity 36.6 cd/lm
 LEDs/each optic 1
 Light colour White
 Required components:

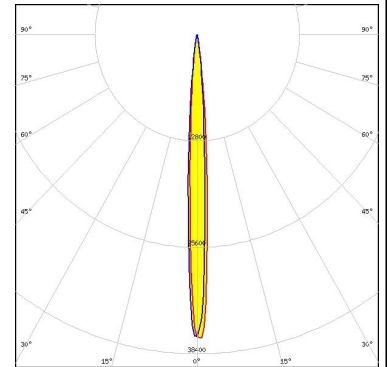
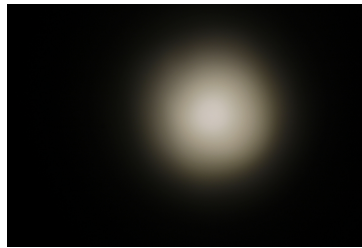

LED NWSx229A
 FWHM 10.0°
 Efficiency 91 %
 Peak intensity 18.6 cd/lm
 LEDs/each optic 1
 Light colour White
 Required components:

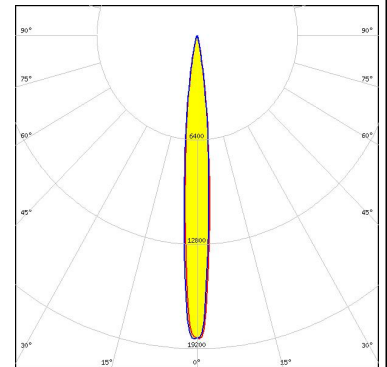

LED OSLOM Square EC
 FWHM 6.0°
 Efficiency 92 %
 Peak intensity 52 cd/lm
 LEDs/each optic 1
 Light colour White
 Required components:

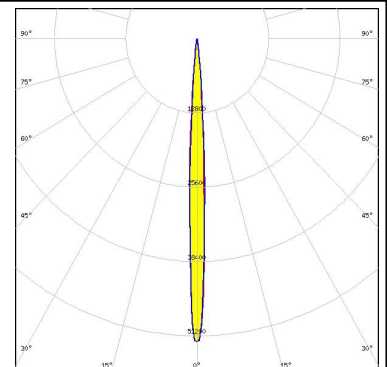

PHOTOMETRIC DATA (MEASURED):

OSRAM
Opto Semiconductors

LED OSLON SSL 150
FWHM 4.0°
Efficiency 94 %
Peak intensity 101 cd/lm
LEDs/each optic 1
Light colour White
Required components:

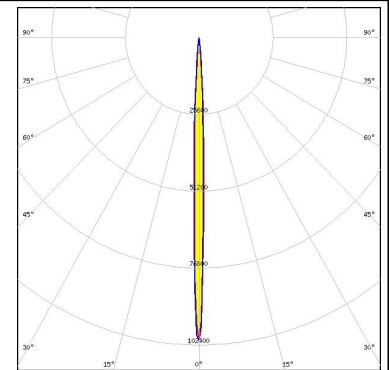

OSRAM
Opto Semiconductors

LED OSLON SSL 80
FWHM 4.0°
Efficiency 90 %
Peak intensity 89 cd/lm
LEDs/each optic 1
Light colour White
Required components:

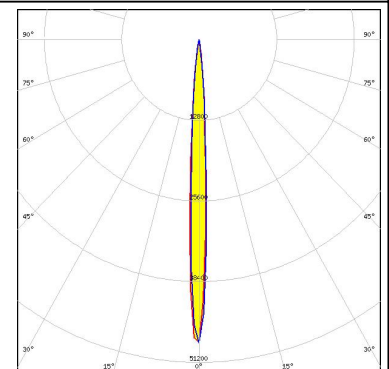

SAMSUNG

LED LH351Z
FWHM 7.0°
Efficiency 89 %
Peak intensity 48.1 cd/lm
LEDs/each optic 1
Light colour White
Required components:

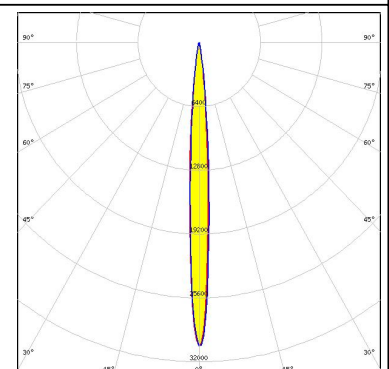
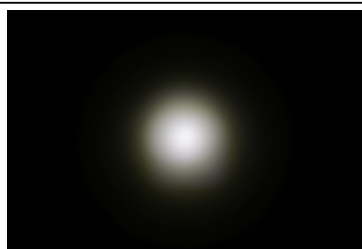

SEOL

SEOUL SEMICONDUCTOR

LED Z5M3
FWHM 7.0°
Efficiency 92 %
Peak intensity 30 cd/lm
LEDs/each optic 1
Light colour White
Required components:



PHOTOMETRIC DATA (SIMULATED):



LED XP-G2 HE
 FWHM 8.0°
 Efficiency 92 %
 Peak intensity 29.7 cd/lm
 LEDs/each optic 1
 Light colour White
 Required components:

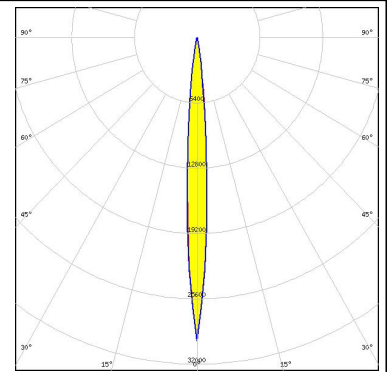

LED XP-G3
 FWHM 7.7°
 Efficiency 91 %
 Peak intensity 28.7 cd/lm
 LEDs/each optic 1
 Light colour White
 Required components:

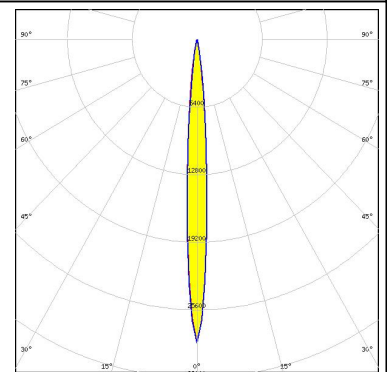

LED XP-L HD
 FWHM 8.6°
 Efficiency 93 %
 Peak intensity 25.3 cd/lm
 LEDs/each optic 1
 Light colour White
 Required components:

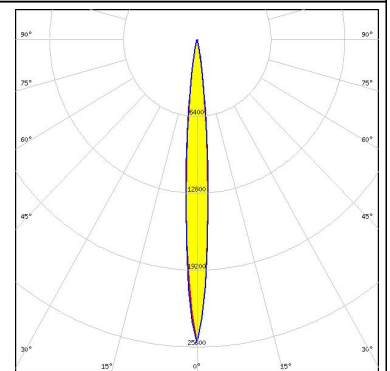

LED XQ-E HD
 FWHM 5.3°
 Efficiency 94 %
 Peak intensity 77.8 cd/lm
 LEDs/each optic 1
 Light colour White
 Required components:

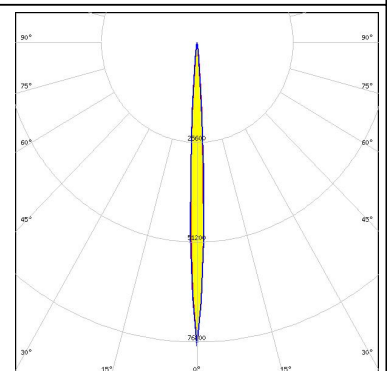

PHOTOMETRIC DATA (SIMULATED):



LED XQ-E HD
 FWHM 5.0°
 Efficiency 93 %
 Peak intensity 80 cd/lm
 LEDs/each optic 1
 Light colour White
 Required components:



LED LUXEON H50-2
 FWHM 7.0°
 Efficiency 94 %
 Peak intensity 38.6 cd/lm
 LEDs/each optic 1
 Light colour White
 Required components:

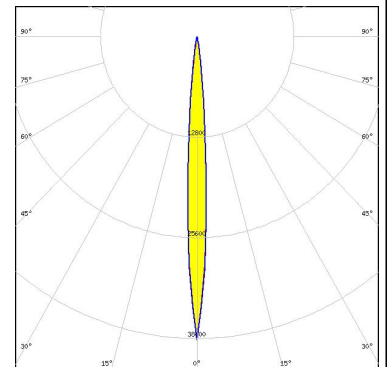

LED LUXEON SunPlus 20 Line (150 deg)
 FWHM 6.0°
 Efficiency 90 %
 Peak intensity 42.7 cd/lm
 LEDs/each optic 1
 Light colour White
 Required components:

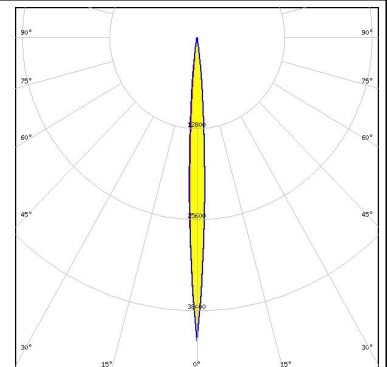

LED LUXEON SunPlus 35 Line
 FWHM 6.0°
 Efficiency 94 %
 Peak intensity 49.9 cd/lm
 LEDs/each optic 1
 Light colour Blue
 Required components:

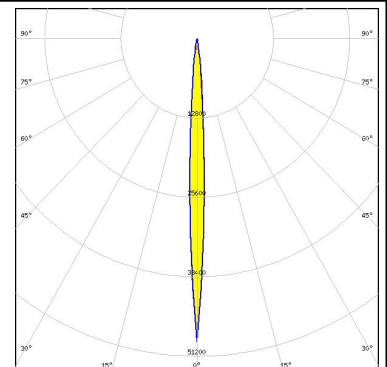

PHOTOMETRIC DATA (SIMULATED):

OSRAM
Opto Semiconductors

LED OSCONIQ P 3737 (2W version)
 FWHM 6.0°
 Efficiency 94 %
 Peak intensity 46.2 cd/lm
 LEDs/each optic 1
 Light colour White
 Required components:

OSRAM
Opto Semiconductors

LED OSLON Black Flat
 FWHM 4.2°
 Efficiency 94 %
 Peak intensity 92 cd/lm
 LEDs/each optic 1
 Light colour White
 Required components:

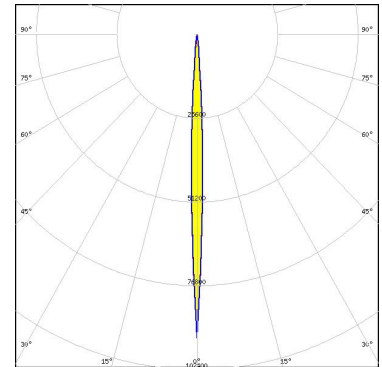

OSRAM
Opto Semiconductors

LED OSLON Black Flat
 FWHM 6.0°
 Efficiency 94 %
 Peak intensity 48.9 cd/lm
 LEDs/each optic 1
 Light colour White
 Required components:

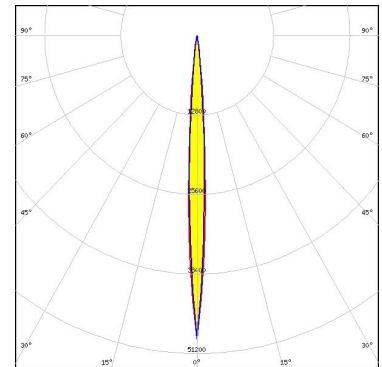

OSRAM
Opto Semiconductors

LED OSLON Square CSSRM2/CSSRM3
 FWHM 6.4°
 Efficiency 94 %
 Peak intensity 48.3 cd/lm
 LEDs/each optic 1
 Light colour White
 Required components:

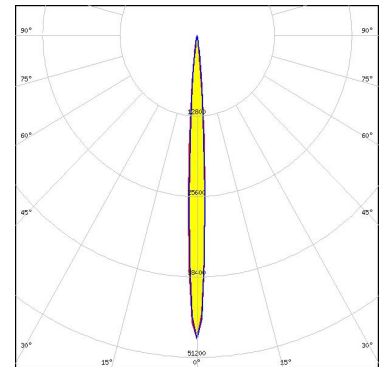

PHOTOMETRIC DATA (SIMULATED):

OSRAM Opto Semiconductors

LED OSTAR Projection Compact (Kx.CSLNM1.xx)
 FWHM 4.0°
 Efficiency 93 %
 Peak intensity 94.8 cd/lm
 LEDs/each optic 1
 Light colour White
 Required components:

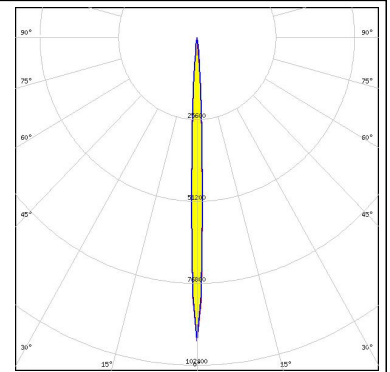

OSRAM Opto Semiconductors

LED OSTAR Projection Compact (Kx.CSLNM1.xx)
 FWHM 6.0°
 Efficiency 94 %
 Peak intensity 76.4 cd/lm
 LEDs/each optic 1
 Light colour White
 Required components:

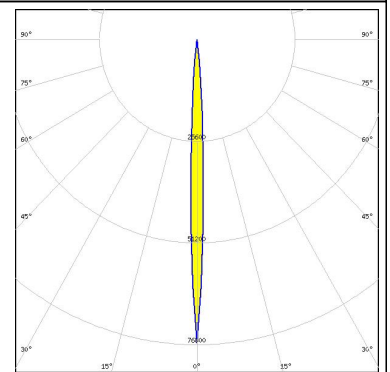

OSRAM Opto Semiconductors

LED SFH 4716AS
 FWHM 6.0°
 Efficiency 94 %
 LEDs/each optic 1
 Light colour IR
 Required components:

SAMSUNG

LED LH351D
 FWHM 9.3°
 Efficiency 90 %
 Peak intensity 21 cd/lm
 LEDs/each optic 1
 Light colour White
 Required components:

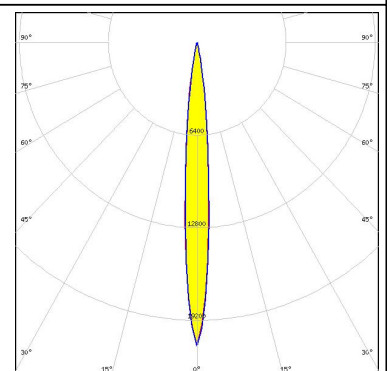

PHOTOMETRIC DATA (SIMULATED):

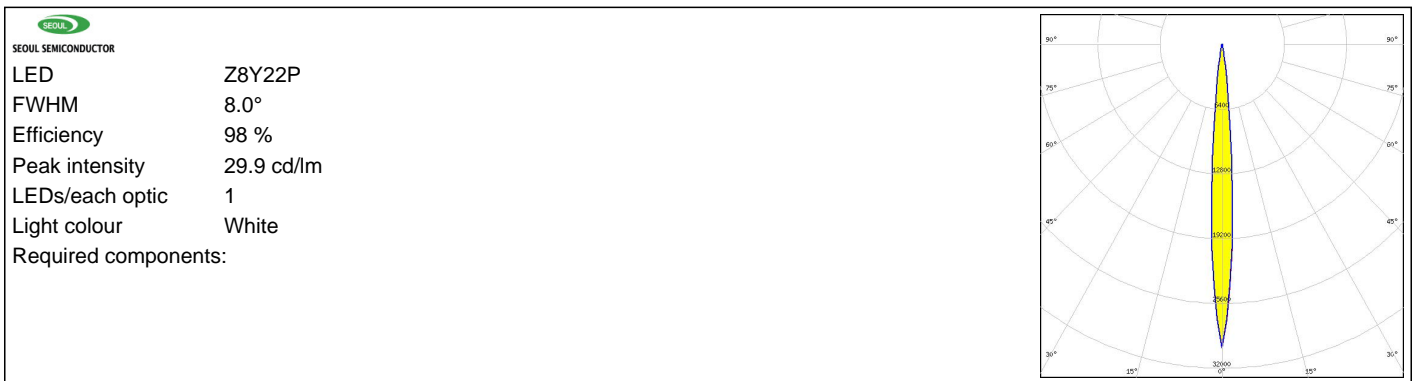

GENERAL INFORMATION:

NOTE: The typical beam angle will be changed by different color, chip size and chip position tolerance. The typical total beam angle is the full angle measured where the luminous intensity is half of the peak value.

MATERIALS:

As part of our continuous research and improvement processes, and to ensure the best possible quality and availability of our products, LEDiL reserves the right to change material grades without notice.

PRODUCT DATA USER AGREEMENT AND DISCLAIMER:

The measured data in the provided downloadable LEDiL Product Datasheets and Mechanical 2D-Drawings is rounded and provided as reference for planning. LEDiL Oy's optical specifications have been verified by conducting performance testing of the products in accordance with the company's quality system. The reported data are averaged results of multiple measurements with typical variation. LEDiL Oy reserves the right to without prior notification make changes and improvements to its products.

LEDiL Oy assumes neither warranty, nor guarantee nor any other liability of any kind for the contents and correctness of the provided data. The provided data has been generated with highest diligence but the provided data may in reality not represent the complete possible variation range of all intrinsic parameters. Therefore, in certain cases a deviation from the provided data could occur.

LEDiL Oy reserves the right to undertake technical changes of its products without further notification which could lead to changes in the provided data. LEDiL Oy assumes no liability of any kind for the possible deviation from any provided data or any other damage resulting from the usage of the provided data.

The user agrees to this disclaimer and user agreement with the download or usage of the provided files.

LEDiL Oy

Joensuunkatu 13
FI-24240 SALO
Finland

LEDiL Inc.

228 West Page Street
Suite D
Sycamore IL 60178
USA

Local sales and technical support

[www.ledil.com/
where_to_buy](http://www.ledil.com/where_to_buy)

Shipping locations

Salo, Finland
Hong Kong, China

Distribution Partners

[www.ledil.com/
where_to_buy](http://www.ledil.com/where_to_buy)

Mouser Electronics

Authorized Distributor

Click to View Pricing, Inventory, Delivery & Lifecycle Information:

[Ledi:](#)

[FCA12077_IRIS](#)