

High Luminous Efficacy  
RGBW LED Emitter  
**LZ4-00MD10**

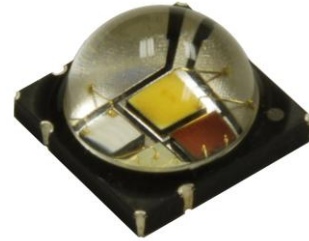

### Key Features

- High Luminous Efficacy 10W RGBW LED
- Individually addressable Red, Green, Blue and Daylight White die
- Electrically neutral thermal path
- Ultra-small foot print – 7.0mm x 7.0mm x 4.3mm
- Surface mount ceramic package with integrated glass lens
- Very low Thermal Resistance (1.8°C/W)
- Very high Luminous Flux density
- New industry standard for Lumen Maintenance (>90% at 100,000 Hours)
- JEDEC Level 1 for Moisture Sensitivity Level
- Autoclave compliant (JEDEC JESD22-A102-C)
- Lead (Pb) free and RoHS compliant
- Reflow solderable (up to 6 cycles)
- Emitter available on [Standard MCPCB](#) (optional)

### Typical Applications

- Architectural Lighting
- Retail Spot and Display Lighting
- Stage and Studio Lighting
- Hospitality Lighting
- Museum Lighting
- Video Walls and Full Color Displays

### Description

The LZ4-00MD10 RGBW LED emitter contains one red, green, blue and daylight white LED die which provides 10W power in an extremely small package. With a 7.0mm x 7.0mm x 4.3mm ultra-small footprint, this package provides exceptional luminous flux density. LedEngin's RGBW LED offers ultimate design flexibility with individually addressable die. The LZ4-00MD10 is capable of producing a continuous spectrum of white light plus millions of colors. The patented design has unparalleled thermal and optical performance. The high quality materials used in the package are chosen to optimize light output and minimize stresses which results in monumental reliability and lumen maintenance. The robust product design thrives in outdoor applications with high ambient temperatures and high humidity.

## Table of Contents

Product Nomenclature . . . . .	3
IPC/JEDEC Moisture Sensitivity . . . . .	3
Average Lumen Maintenance Projections . . . . .	3
Forward Voltage Binning . . . . .	4
Luminous Flux Binning . . . . .	4
Dominant Wavelength Binning . . . . .	4
Daylight White Chromaticity Binning . . . . .	5
Absolute Maximum Ratings . . . . .	6
Optical Characteristics . . . . .	6
Electrical Characteristics . . . . .	6
Mechanical Dimensions . . . . .	7
Pin-Out . . . . .	7
Recommended Solder Pad Layout . . . . .	7
Reflow Soldering Profile . . . . .	8
Typical Radiation Pattern . . . . .	9
Typical Relative Spectral Power Distribution . . . . .	9
Typical Dominant Wavelength Shift . . . . .	10
Typical Dominant Wavelength Shift over Temperature . . . . .	10
Typical Relative Light Output . . . . .	11
Typical Relative Light Output over Temperature . . . . .	11
Typical Forward Current Characteristics . . . . .	12
Current Derating Curves . . . . .	12
Emitter Tape & Reel Specifications . . . . .	13
Company Information . . . . .	14

## Product Nomenclature

The LZ Series base part number designation is defined as follows:

L Z A – B C D E F G

Where:

A – designates the number of LED die in the package (“4” for 10W)

B – designates the package level (“0” for Emitter)

C – designates the radiation pattern (“0” for Lambertian)

D and E – designate the color (“MD” for “RGBW” Mixed Dice)

F and G – designate the Power (“10” for 10W typical rating)

Ordering information:

For ordering LedEngin products, please reference the base part number above. The base part number represents any of the flux or dominant wavelength bins specified in the binning tables below. For ordering products with special bin selections, please contact a LedEngin sales representative or authorized distributor.

## IPC/JEDEC Moisture Sensitivity Level

Table 1 - IPC/JEDEC J-STD-20D.1 MSL Classification:

Level	Soak Requirements					
	Floor Life		Standard		Accelerated	
	Time	Conditions	Time (hrs)	Conditions	Time (hrs)	Conditions
1	Unlimited	≤ 30°C/ 85% RH	168 +5/-0	85°C/ 85% RH	n/a	n/a

Notes for Table 1:

1. The standard soak time includes a default value of 24 hours for semiconductor manufacturer's exposure time (MET) between bake and bag and includes the maximum time allowed out of the bag at the distributor's facility.

## Average Lumen Maintenance Projections

Lumen maintenance generally describes the ability of a lamp to retain its output over time. The useful lifetime for solid state lighting devices (Power LEDs) is also defined as Lumen Maintenance, with the percentage of the original light output remaining at a defined time period.

Based on long-term WHTOL testing, LedEngin projects that the LZ Series will deliver, on average, 90% Lumen Maintenance at 100,000 hours of operation at a forward current of 700 mA. This projection is based on constant current operation with junction temperature maintained at or below 125°C.

## Forward Voltage Bin

Table 2:

Bin Code	Minimum Forward Voltage ( $V_F$ ) @ $I_F = 700\text{mA}^{[1]}$ (V)				Maximum Forward Voltage ( $V_F$ ) @ $I_F = 700\text{mA}^{[1]}$ (V)			
	Red	Green	Blue	White	Red	Green	Blue	White
	0	2.24	3.68	3.20	3.20	3.20	5.12	4.16

Notes for Table 2:

1. LedEngin maintains a tolerance of  $\pm 0.04\text{V}$  on forward voltage measurements.

## Luminous Flux Bins

Table 3:

Bin Code	Minimum Luminous Flux ( $\Phi_V$ ) @ $I_F = 700\text{mA}^{[1,2]}$ (lm)				Maximum Luminous Flux ( $\Phi_V$ ) @ $I_F = 700\text{mA}^{[1,2]}$ (lm)				Typical Luminous Flux ( $\Phi_V$ ) @ $I_F = 1000\text{mA}^{[1,2]}$ (lm)			
	Red	Green	Blue	White	Red	Green	Blue	White	Red	Green	Blue	White
	E			24				31				37
F			31				38				43	
K	75				93				110			
L	93	93			117	117			130	135		
M		117		117		146		146		160		180
N				146				182				215
P				182				228				265

Notes for Table 3:

1. Luminous flux performance guaranteed within published operating conditions. LedEngin maintains a tolerance of  $\pm 10\%$  on flux measurements.
2. Future products will have even higher levels of radiant flux performance. Contact LedEngin Sales for updated information.

## Dominant Wavelength Bins

Table 4:

Bin Code	Minimum Dominant Wavelength ( $\lambda_D$ ) @ $I_F = 700\text{mA}^{[1]}$ (nm)			Maximum Dominant Wavelength ( $\lambda_D$ ) @ $I_F = 700\text{mA}^{[1]}$ (nm)		
	Red	Green	Blue	Red	Green	Blue
	R2	620			630	
G2		520			525	
G3		525			530	
B4			455			460
B5			460			465
B6			465			470

Notes for Table 4:

1. LedEngin maintains a tolerance of  $\pm 0.5\text{nm}$  on dominant wavelength measurements.

## Daylight White Chromaticity Groups

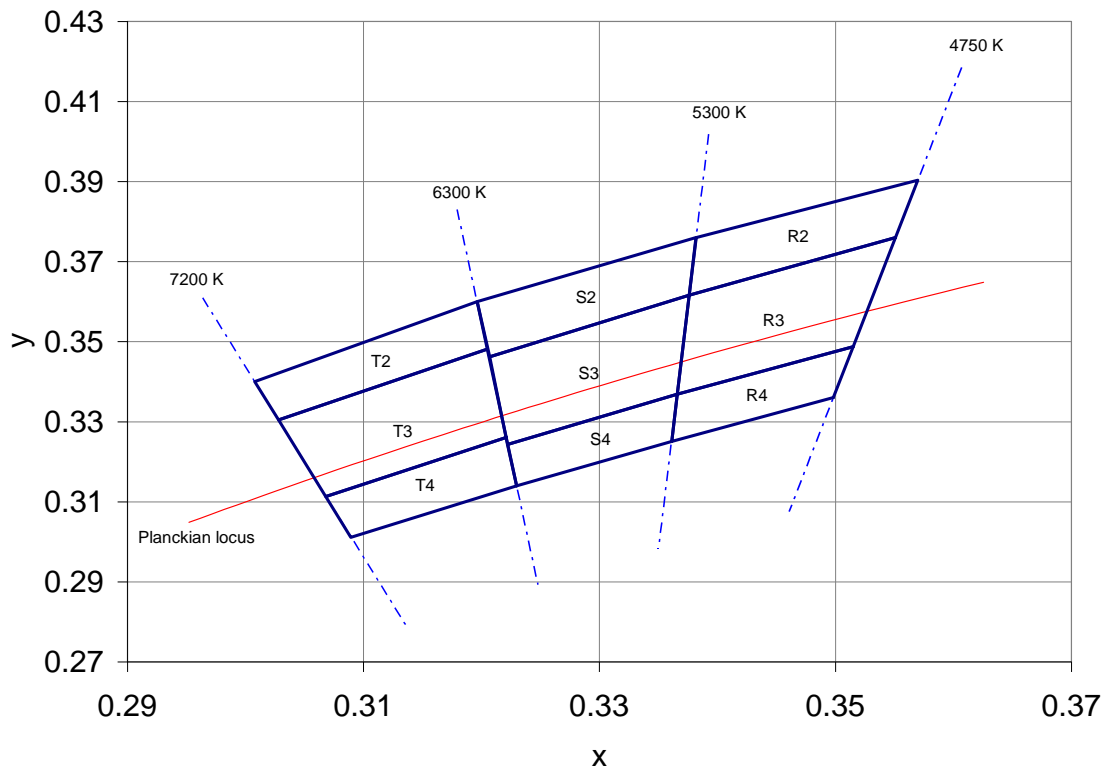

Figure 1: Standard Chromaticity Groups plotted on excerpt from the CIE 1931 (2°) x-y Chromaticity Diagram. Coordinates are listed below in Table 3.

## Daylight White Chromaticity Coordinates

Table 5:

Bin Code	x	y	Typical CCT (K)	Bin Code	x	y	Typical CCT (K)	Bin Code	x	y	Typical CCT (K)
T2	0.3205	0.3481	6750	S2	0.3376	0.3616	5800	R2	0.3551	0.3760	5000
	0.3196	0.3600			0.3382	0.3760			0.3570	0.3903	
	0.3008	0.3400			0.3196	0.3600			0.3382	0.3760	
	0.3028	0.3304			0.3207	0.3462			0.3376	0.3616	
T3	0.3221	0.3261	6750	S3	0.3366	0.3369	5800	R3	0.3515	0.3487	5000
	0.3205	0.3481			0.3376	0.3616			0.3551	0.3760	
	0.3028	0.3304			0.3207	0.3462			0.3376	0.3616	
	0.3068	0.3113			0.3222	0.3243			0.3366	0.3369	
T4	0.3230	0.3140	6750	S4	0.3361	0.3251	5800	R4	0.3498	0.3360	5000
	0.3221	0.3261			0.3366	0.3369			0.3515	0.3487	
	0.3068	0.3113			0.3222	0.3243			0.3366	0.3369	
	0.3089	0.3011			0.3230	0.3140			0.3361	0.3251	

## Absolute Maximum Ratings

Table 6:

Parameter	Symbol	Value	Unit
DC Forward Current <sup>[1]</sup>	$I_F$	1000	mA
Peak Pulsed Forward Current <sup>[2]</sup>	$I_{FP}$	1500	mA
Reverse Voltage	$V_R$	See Note 3	V
Storage Temperature	$T_{stg}$	-40 ~ +150	°C
Junction Temperature [blue, green, white]	$T_J$	150	°C
Junction Temperature [red]	$T_J$	125	°C
Soldering Temperature <sup>[4]</sup>	$T_{sol}$	260	°C
Allowable Reflow Cycles		6	
Autoclave Conditions <sup>[5]</sup>		121°C at 2 ATM, 100% RH for 168 hours	
ESD Sensitivity <sup>[6]</sup>		> 8,000 V HBM Class 3B JESD22-A114-D	

Notes for Table 6:

- Maximum DC forward current is determined by the overall thermal resistance and ambient temperature. Follow the curves in Figure 12 for current derating.
- Pulse forward current conditions: Pulse Width  $\leq$  10msec and Duty Cycle  $\leq$  10%.
- LEDs are not designed to be reverse biased.
- Solder conditions per JEDEC 020D. See Reflow Soldering Profile Figure 4.
- Autoclave Conditions per JEDEC JESD22-A102-C.
- LedEngin recommends taking reasonable precautions towards possible ESD damages and handling the LZ4-00MD10 in an electrostatic protected area (EPA). An EPA may be adequately protected by ESD controls as outlined in ANSI/ESD S6.1.

## Optical Characteristics @ $T_C = 25^\circ\text{C}$

Table 7:

Parameter	Symbol	Typical				Unit
		Red	Green	Blue <sup>[1]</sup>	White	
Luminous Flux (@ $I_F = 700\text{mA}$ )	$\Phi_V$	87	120	32	160	lm
Luminous Flux (@ $I_F = 1000\text{mA}$ )	$\Phi_V$	105	145	42	205	lm
Dominant Wavelength		625	523	460		
Correlated Color Temperature	CCT				5500	K
Chromaticity Coordinates	x,y				0.33, 0.34	
Color Rendering Index for White (CRI)	$R_a$				75	
Viewing Angle <sup>[2]</sup>	$2\Theta_{1/2}$		95			
Total Included Angle <sup>[3]</sup>	$\Theta_{0.9}$		115			Degrees

Notes for Table 7:

- When operating the Blue LED, observe IEC 60825-1 class 2 rating. Do not stare into the beam.
- Viewing Angle is the off axis angle from emitter centerline where the luminous intensity is  $\frac{1}{2}$  of the peak value.
- Total Included Angle is the total angle that includes 90% of the total luminous flux.

## Electrical Characteristics @ $T_C = 25^\circ\text{C}$

Table 8:

Parameter	Symbol	Typical				Unit
		Red	Green	Blue	White	
Forward Voltage (@ $I_F = 700\text{mA}$ )	$V_F$	2.4	4.2	3.5	3.5	V
Forward Voltage (@ $I_F = 1000\text{mA}$ )	$V_F$	2.6	4.5	3.7	3.7	V
Temperature Coefficient of Forward Voltage	$\Delta V_F / \Delta T_J$	-1.9	-2.9	-3.0	-3.0	mV/°C
Thermal Resistance (Junction to Case)	$R\Theta_{J-C}$		1.8			°C/W

## Mechanical Dimensions (mm)

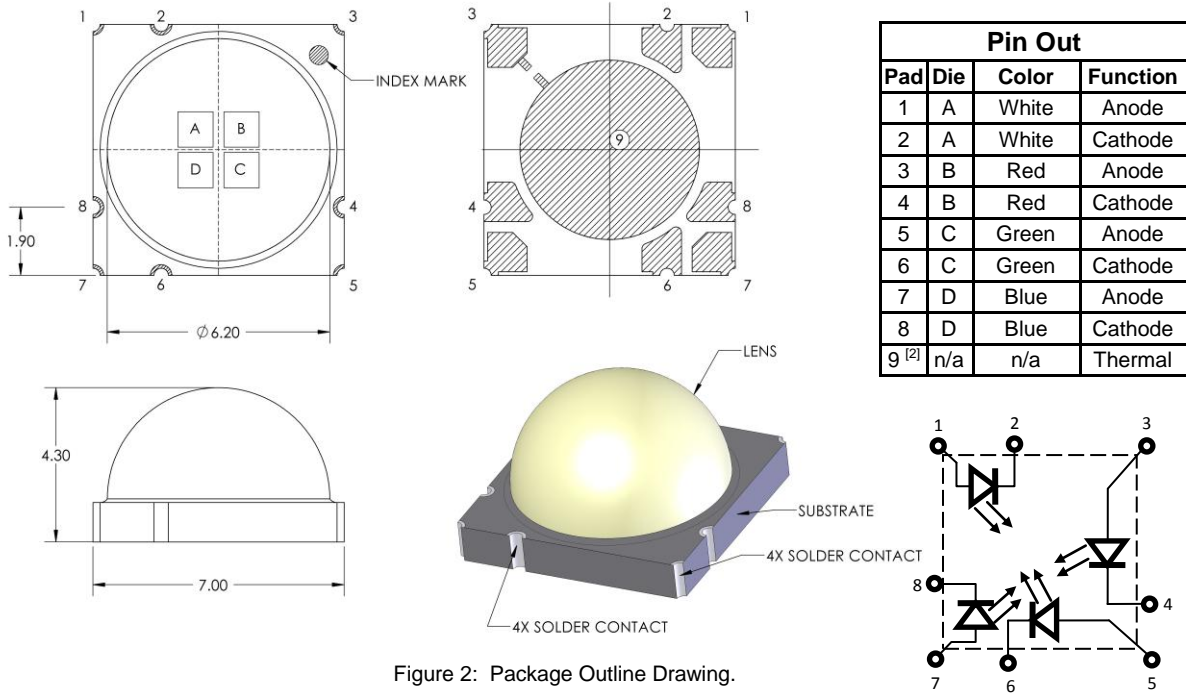

Figure 2: Package Outline Drawing.

Notes for Figure 2:

1. Unless otherwise noted, the tolerance =  $\pm 0.20$  mm.
2. Thermal contact, Pad 9, is electrically neutral.

## Recommended Solder Pad Layout (mm)

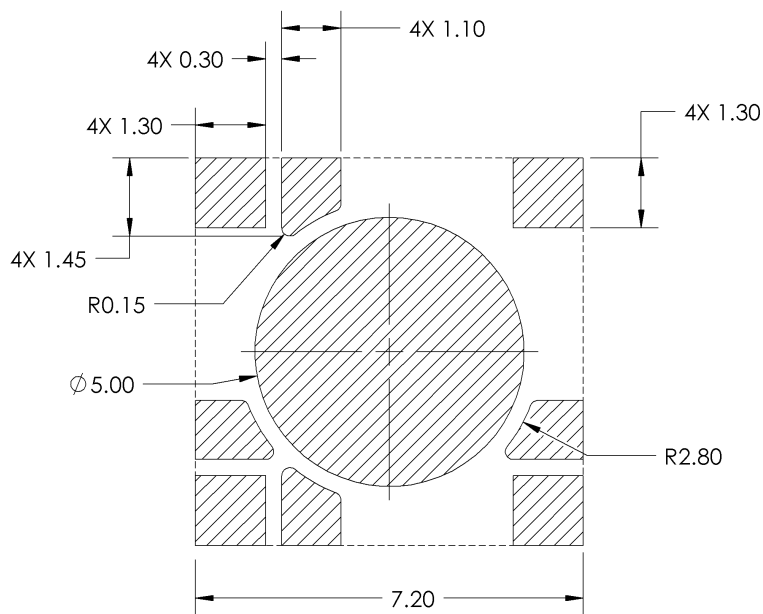

Figure 3: Recommended solder mask opening (hatched area) for anode, cathode, and thermal pad.

Note for Figure 3:

1. Unless otherwise noted, the tolerance =  $\pm 0.20$  mm.

## Reflow Soldering Profile

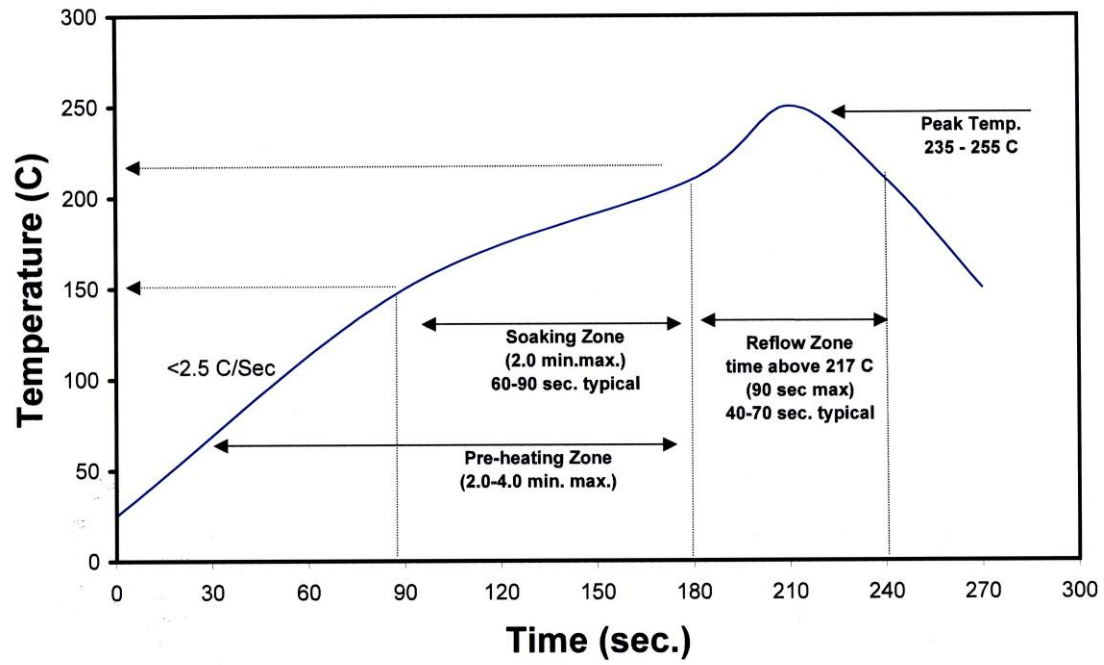

Figure 4: Reflow soldering profile for lead free soldering.



## Typical Radiation Pattern

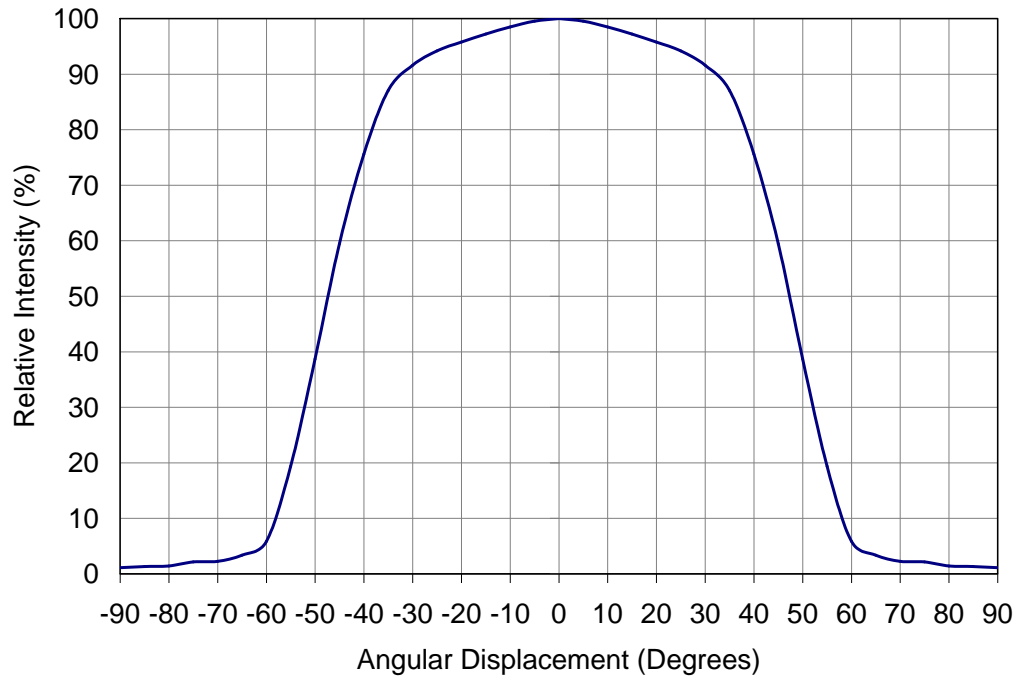

Figure 5: Typical representative spatial radiation pattern.

## Typical Relative Spectral Power Distribution

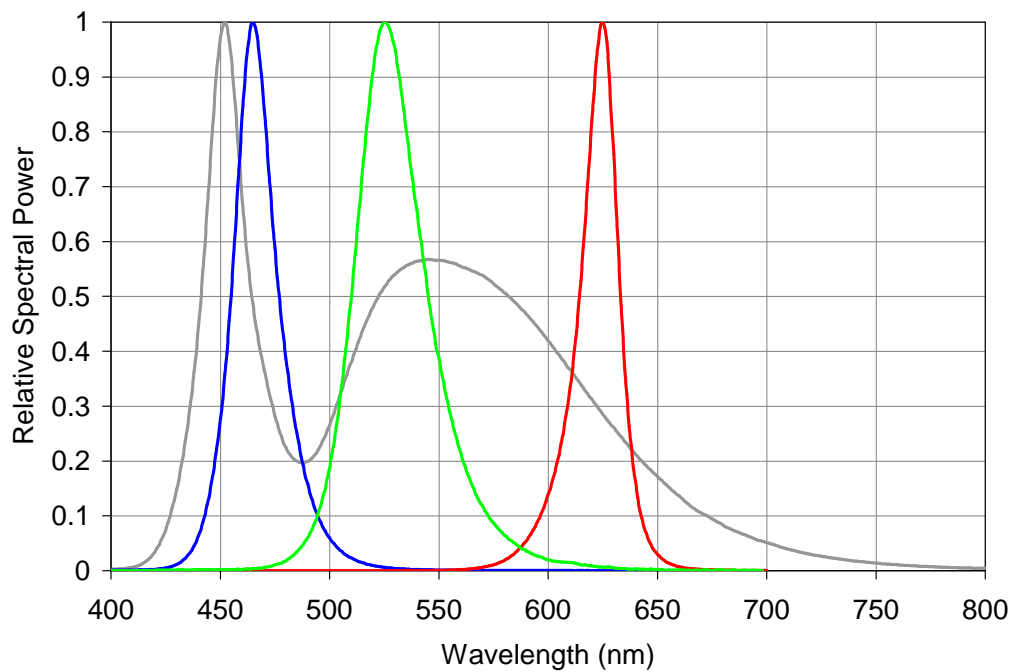

Figure 6: Typical relative spectral power vs. wavelength @  $T_c = 25^\circ\text{C}$ .

## Typical Dominant Wavelength Shift

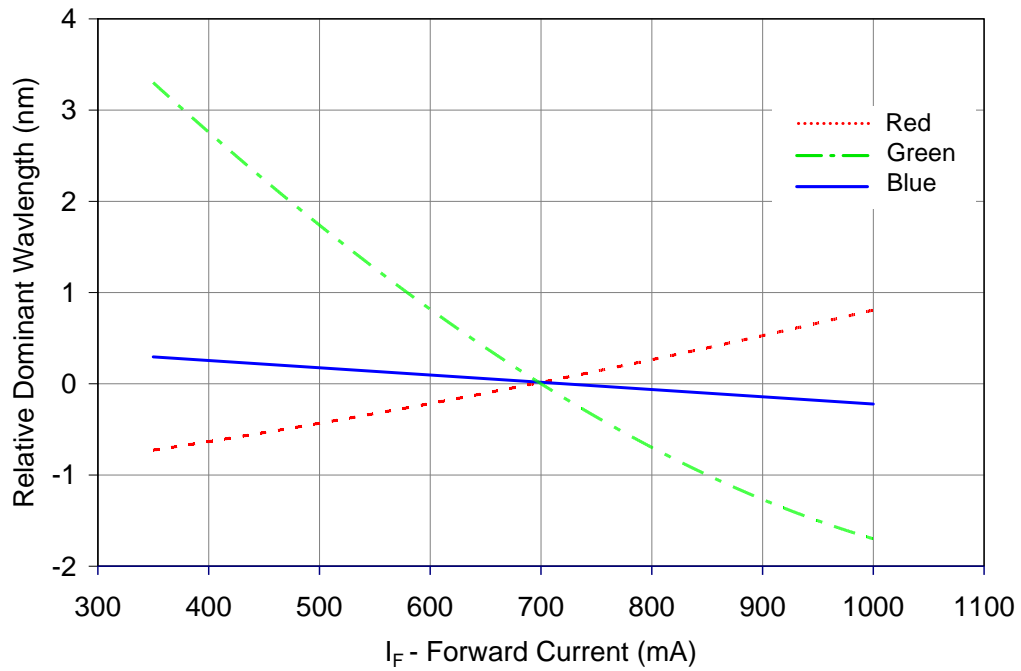

Figure 7: Typical dominant wavelength shift vs. forward current @ T<sub>c</sub> = 25°C.

## Dominant Wavelength Shift over Temperature

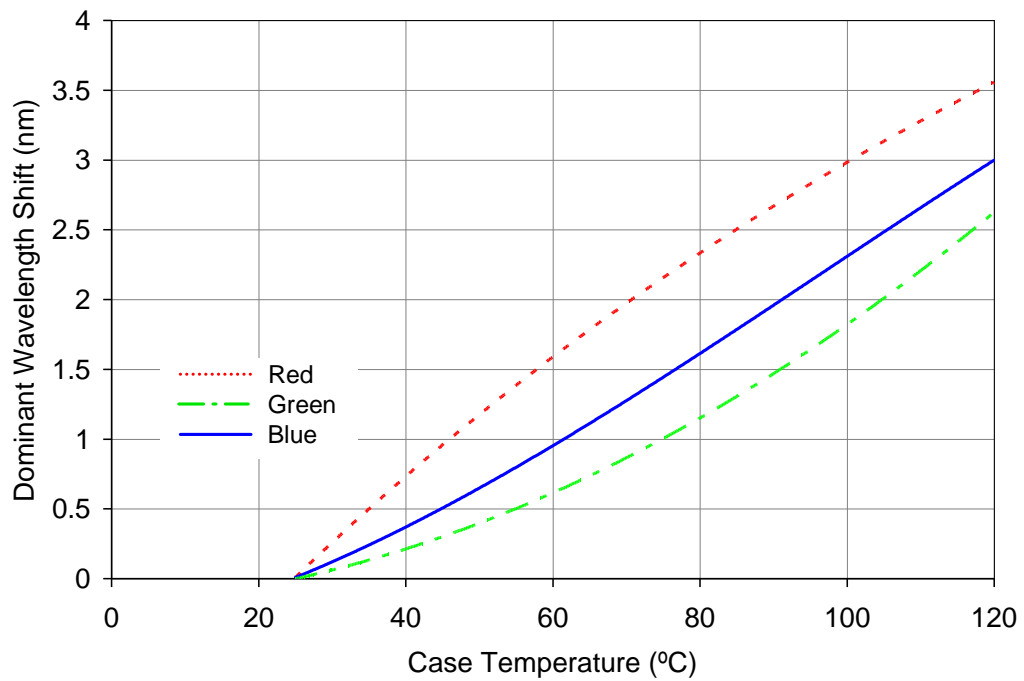

Figure 8: Typical dominant wavelength shift vs. case temperature.

## Typical Relative Light Output

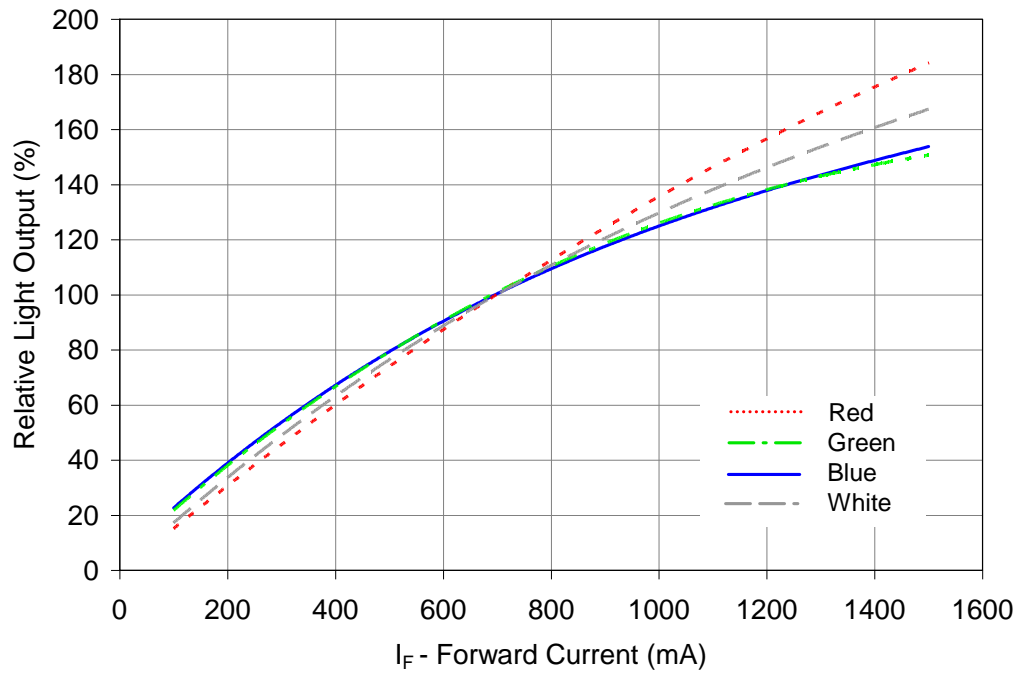

Figure 9: Typical relative light output vs. forward current @ T<sub>c</sub> = 25°C.

## Typical Relative Light Output over Temperature

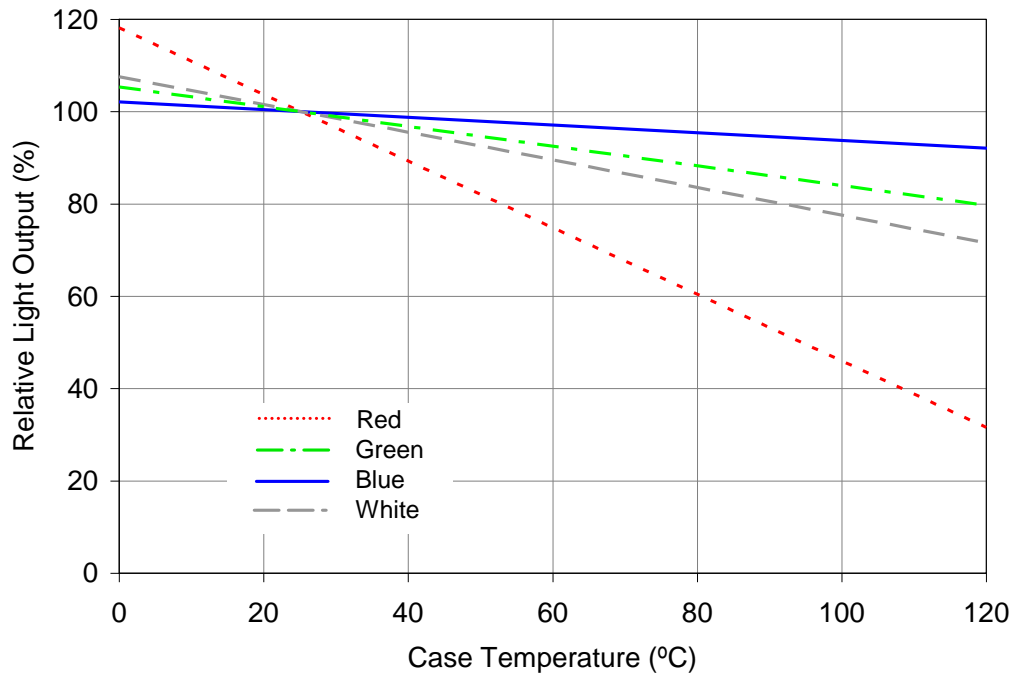

Figure 10: Typical relative light output vs. case temperature.

## Typical Forward Current Characteristics

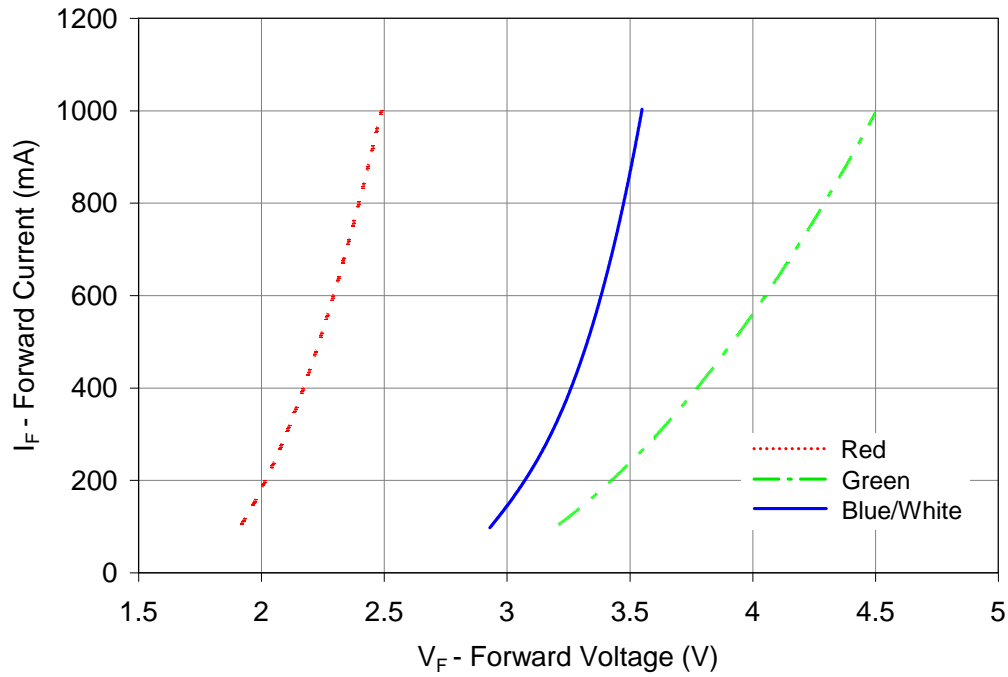

Figure 11: Typical forward current vs. forward voltage @  $T_C = 25^\circ\text{C}$ .

## Current Derating

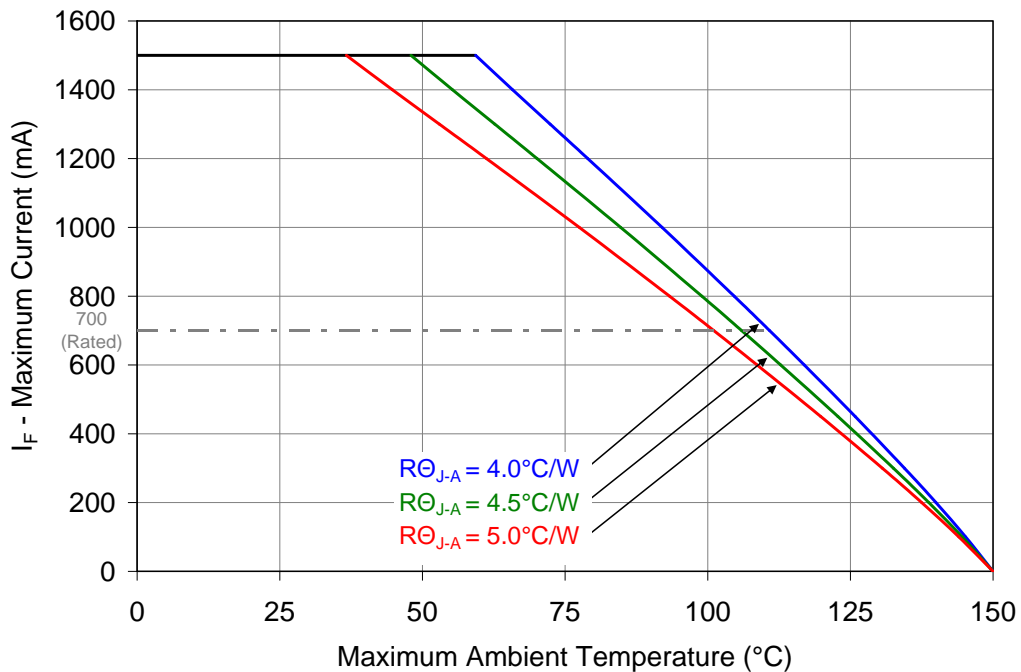

Figure 12: Maximum forward current vs. ambient temperature based on  $T_{J(\text{MAX})} = 150^\circ\text{C}$ .

Notes for Figure 12:

1. Maximum current assumes that all four LED dice are operating concurrently at the same current.
2.  $R_{\theta_{J-C}}$  [Junction to Case Thermal Resistance] for the LZ4-00MD10 is typically  $1.8^\circ\text{C/W}$ .
3.  $R_{\theta_{J-A}}$  [Junction to Ambient Thermal Resistance] =  $R_{\theta_{J-C}} + R_{\theta_{C-A}}$  [Case to Ambient Thermal Resistance].

## Emitter Tape and Reel Specifications (mm)

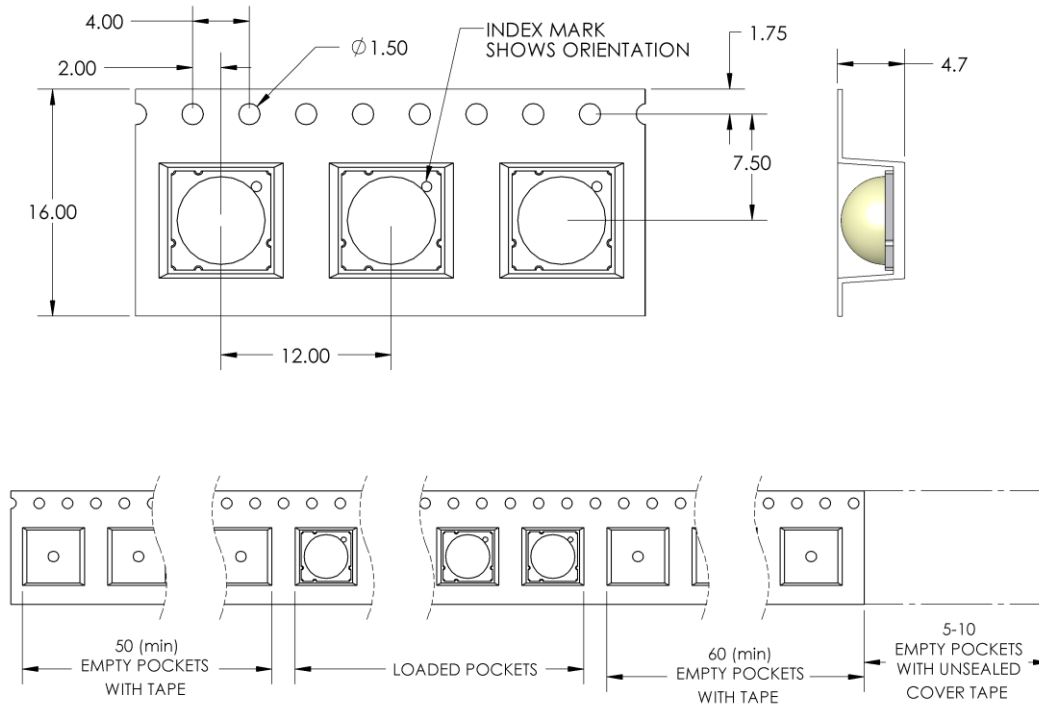

Figure 13: Emitter carrier tape specifications (mm).

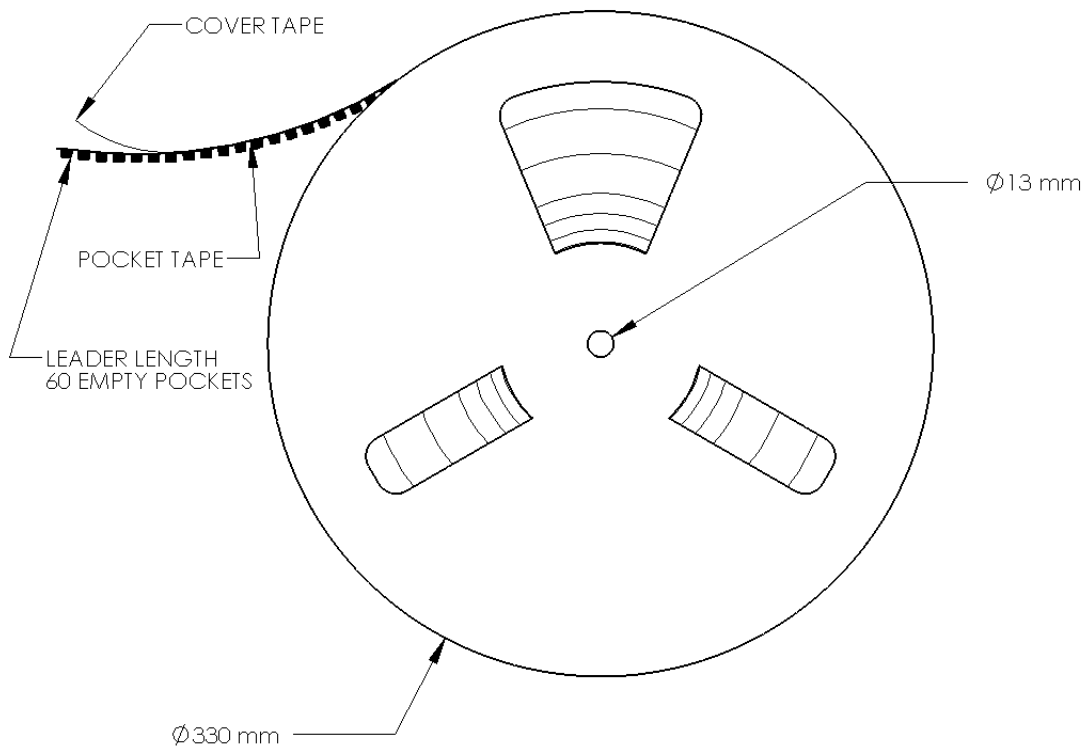

Figure 14: Emitter reel specifications (mm).

## Company Information

LedEngin, Inc. is a Silicon Valley based solid-state lighting company specializing in the development and manufacturing of unprecedented high-power LED emitters, modules and replacement lamps. LedEngin's packaging technologies lead the industry with products that feature lowest thermal resistance, highest flux density and consummate reliability, enabling compact and efficient solid state lighting solutions.

LedEngin's LED emitters range from 3W to 90W with ultra-compact footprints and are available in single color products including Cool White, Neutral White, Warm White, Red, Green, Blue, Amber, Deep Red, Far Red, Dental Blue and UV as well as multi-color products with RGB, RGBA and RGBW options. LedEngin's brightest White LEDs are capable of emitting 5,000 lumens.

LedEngin's robust emitters are at the core of its unique line of modules and replacement lamps producing unmatched beam quality resulting in true Lux on Target™ for a wide variety of spot and narrow flood directional lighting applications.

LedEngin is committed to providing products that conserve natural resources and reduce greenhouse emissions.

LedEngin reserves the right to make changes to improve performance without notice.

Please contact [Sales@ledengin.com](mailto:Sales@ledengin.com) or (408) 492-0620 for more information.

# Mouser Electronics

Authorized Distributor

Click to View Pricing, Inventory, Delivery & Lifecycle Information:

[LED Engin:](#)

[LZ4-00MD10](#) [LZ4-20MD10](#)