

High Luminous Efficacy
RGBA LED Emitter
LZ4-00MA10

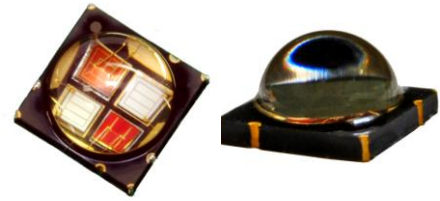

Key Features

- High Luminous Efficacy 10W RGBA LED
- Individually addressable Red, Green, Blue and Amber die
- White point tunable to any CCT or hue with enhanced CRI
- Electrically neutral thermal path
- Ultra-small foot print – 7.0mm x 7.0mm x 4.3mm
- Surface mount ceramic package with integrated glass lens
- Very low Thermal Resistance (1.8°C/W)
- Very high Luminous Flux density
- New industry standard for Lumen Maintenance (>90% at 100,000 Hours)
- JEDEC Level 1 for Moisture Sensitivity Level
- Autoclave compliant (JEDEC JESD22-A102-C)
- Lead (Pb) free and RoHS compliant
- Reflow solderable (up to 6 cycles)
- Emitter available on [Standard MCPCB](#) (optional)

Typical Applications

- Architectural Lighting
- Retail Spot and Display Lighting
- Stage and Studio Lighting
- Hospitality Lighting
- Museum Lighting
- Dental and Medical Illumination
- Microscope Illumination
- Video Walls and Full Color Displays

Description

The LZ4-00MA10 RGBA LED emitter contains one red, green, blue and amber LED die which provides 10W power in an extremely small package. With a 7.0mm x 7.0mm x 4.3mm ultra-small footprint, this package provides exceptional luminous flux density. LedEngin's RGBA LED offers ultimate design flexibility with individually addressable die. The LZ4-00MA10 is capable of producing any white color temperature with CRI values on the order of 90+ and millions of colors. The patent-pending design has unparalleled thermal and optical performance. The high quality materials used in the package are chosen to optimize light output and minimize stresses which results in monumental reliability and lumen maintenance. The robust product design thrives in outdoor applications with high ambient temperatures and high humidity.

Table of Contents

Product Nomenclature	3
IPC/JEDEC Moisture Sensitivity	3
Average Lumen Maintenance Projections	3
Luminous Flux Binning.	4
Dominant Wavelength Binning	4
Forward Voltage Binning	4
Absolute Maximum Ratings	5
Optical Characteristics	5
Electrical Characteristics	5
Mechanical Dimensions	6
Pin-Out	6
Recommended Solder Pad Layout	6
Reflow Soldering Profile	7
Typical Radiation Pattern	8
Typical Relative Spectral Power Distribution	8
Typical Dominant Wavelength Shift	9
Typical Dominant Wavelength Shift over Temperature	9
Typical Relative Light Output	10
Typical Relative Light Output over Temperature	10
Typical Forward Current Characteristics	11
Current Derating Curves	11
Emitter Tape & Reel Specifications	12
Company Information	13

Product Nomenclature

The LZ Series base part number designation is defined as follows:

L Z A – B C D E F G

Where:

- A – designates the number of LED die in the package (“4” for 10W)
- B – designates the package level (“0” for Emitter)
- C – designates the radiation pattern (“0” for Lambertian)
- D and E – designate the color (“MA” for “RGBA” Mixed Dice)
- F and G – designate the Power (“10” for 10W typical rating)

Ordering information:

For ordering LedEngin products, please reference the base part number above. The base part number represents any of the flux or dominant wavelength bins specified in the binning tables below. For ordering products with special bin selections, please contact a LedEngin sales representative or authorized distributor.

IPC/JEDEC Moisture Sensitivity Level

Table 1 - IPC/JEDEC J-STD-20D.1 MSL Classification:

Level	Soak Requirements					
	Floor Life		Standard		Accelerated	
	Time	Conditions	Time (hrs)	Conditions	Time (hrs)	Conditions
1	Unlimited	≤ 30°C/ 85% RH	168 +5/-0	85°C/ 85% RH	n/a	n/a

Notes for Table 1:

1. The standard soak time includes a default value of 24 hours for semiconductor manufacturer’s exposure time (MET) between bake and bag and includes the maximum time allowed out of the bag at the distributor’s facility.

Average Lumen Maintenance Projections

Lumen maintenance generally describes the ability of a lamp to retain its output over time. The useful lifetime for solid state lighting devices (Power LEDs) is also defined as Lumen Maintenance, with the percentage of the original light output remaining at a defined time period.

Based on long-term WHTOL testing, LedEngin projects that the LZ Series will deliver, on average, 90% Lumen Maintenance at 100,000 hours of operation at a forward current of 700 mA. This projection is based on constant current operation with junction temperature maintained at or below 125°C.

Luminous Flux Bins

Table 2:

Bin Code	Minimum Luminous Flux (Φ_V) @ $I_F = 700\text{mA}$ ^[1,2] (lm)				Maximum Luminous Flux (Φ_V) @ $I_F = 700\text{mA}$ ^[1,2] (lm)				Typical Luminous Flux (Φ_V) @ $I_F = 1000\text{mA}$ ^[1,2] (lm)			
	Red	Green	Blue	Amber	Red	Green	Blue	Amber	Red	Green	Blue	Amber
	E			24				31				37
F			31				38				43	
J				60				75				90
K	75			75	93			93	110			105
L	93	93			117	117			130	135		
M		117				146				160		

Notes for Table 2:

- Luminous flux performance guaranteed within published operating conditions. LedEngin maintains a tolerance of $\pm 10\%$ on flux measurements.
- Future products will have even higher levels of radiant flux performance. Contact LedEngin Sales for updated information.

Dominant Wavelength Bins

Table 3:

Bin Code	Minimum Dominant Wavelength (λ_D) @ $I_F = 700\text{mA}$ ^[1] (nm)				Maximum Dominant Wavelength (λ_D) @ $I_F = 700\text{mA}$ ^[1] (nm)			
	Red	Green	Blue	Amber	Red	Green	Blue	Amber
	R2	620				630		
G2		520				525		
G3		525				530		
B4			455				460	
B5			460				465	
B6			465				470	
A8				585				590
A9				590				595

Notes for Table 3:

- LedEngin maintains a tolerance of $\pm 0.5\text{nm}$ on dominant wavelength measurements.

Forward Voltage Bin

Table 4:

Bin Code	Minimum Forward Voltage (V_F) @ $I_F = 700\text{mA}$ ^[1] (V)				Maximum Forward Voltage (V_F) @ $I_F = 700\text{mA}$ ^[1] (V)			
	Red	Green	Blue	Amber	Red	Green	Blue	Amber
	0	2.24	3.44	3.20	2.24	3.20	4.64	4.16

Notes for Table 4:

- LedEngin maintains a tolerance of $\pm 0.04\text{V}$ on forward voltage measurements.

Absolute Maximum Ratings

Table 5:

Parameter	Symbol	Value	Unit
DC Forward Current ^[1]	I_F	1000	mA
Peak Pulsed Forward Current ^[2]	I_{FP}	1500	mA
Reverse Voltage	V_R	See Note 3	V
Storage Temperature	T_{stg}	-40 ~ +150	°C
Junction Temperature	T_J	150	°C
Soldering Temperature ^[4]	T_{sol}	260	°C
Allowable Reflow Cycles		6	
Autoclave Conditions ^[5]		121°C at 2 ATM, 100% RH for 168 hours	
ESD Sensitivity ^[6]		> 8,000 V HBM Class 3B JESD22-A114-D	

Notes for Table 5:

- Maximum DC forward current is determined by the overall thermal resistance and ambient temperature. Follow the curves in Figure 11 for current derating.
- Pulse forward current conditions: Pulse Width \leq 10msec and Duty Cycle \leq 10%.
- LEDs are not designed to be reverse biased.
- Solder conditions per JEDEC 020D. See Reflow Soldering Profile Figure 3.
- Autoclave Conditions per JEDEC JESD22-A102-C.
- LedEngin recommends taking reasonable precautions towards possible ESD damages and handling the LZ4-00MA10 in an electrostatic protected area (EPA). An EPA may be adequately protected by ESD controls as outlined in ANSI/ESD S6.1.

Optical Characteristics @ $T_C = 25^\circ\text{C}$

Table 6:

Parameter	Symbol	Typical				Unit
		Red	Green	Blue ^[1]	Amber	
Luminous Flux (@ $I_F = 700\text{mA}$)	Φ_V	87	120	32	73	lm
Luminous Flux (@ $I_F = 1000\text{mA}$)	Φ_V	105	145	42	91	lm
Dominant Wavelength	λ_D	625	523	460	590	nm
Viewing Angle ^[2]	$2\Theta_{1/2}$			95	Degrees	
Total Included Angle ^[3]	$\Theta_{0.9}$			115	Degrees	

Notes for Table 6:

- When operating the Blue LED, observe IEC 60825-1 class 2 rating. Do not stare into the beam.
- Viewing Angle is the off axis angle from emitter centerline where the luminous intensity is $\frac{1}{2}$ of the peak value.
- Total Included Angle is the total angle that includes 90% of the total luminous flux.

Electrical Characteristics @ $T_C = 25^\circ\text{C}$

Table 7:

Parameter	Symbol	Typical				Unit
		Red	Green	Blue	Amber	
Forward Voltage (@ $I_F = 700\text{mA}$)	V_F	2.4	3.9	3.5	2.5	V
Forward Voltage (@ $I_F = 1000\text{mA}$)	V_F	2.6	4.1	3.7	2.7	V
Temperature Coefficient of Forward Voltage	$\Delta V_F / \Delta T_J$	-1.9	-2.9	-3.0	-2.8	mV/°C
Thermal Resistance (Junction to Case)	$R\Theta_{J-c}$			1.8	°C/W	

Mechanical Dimensions (mm)

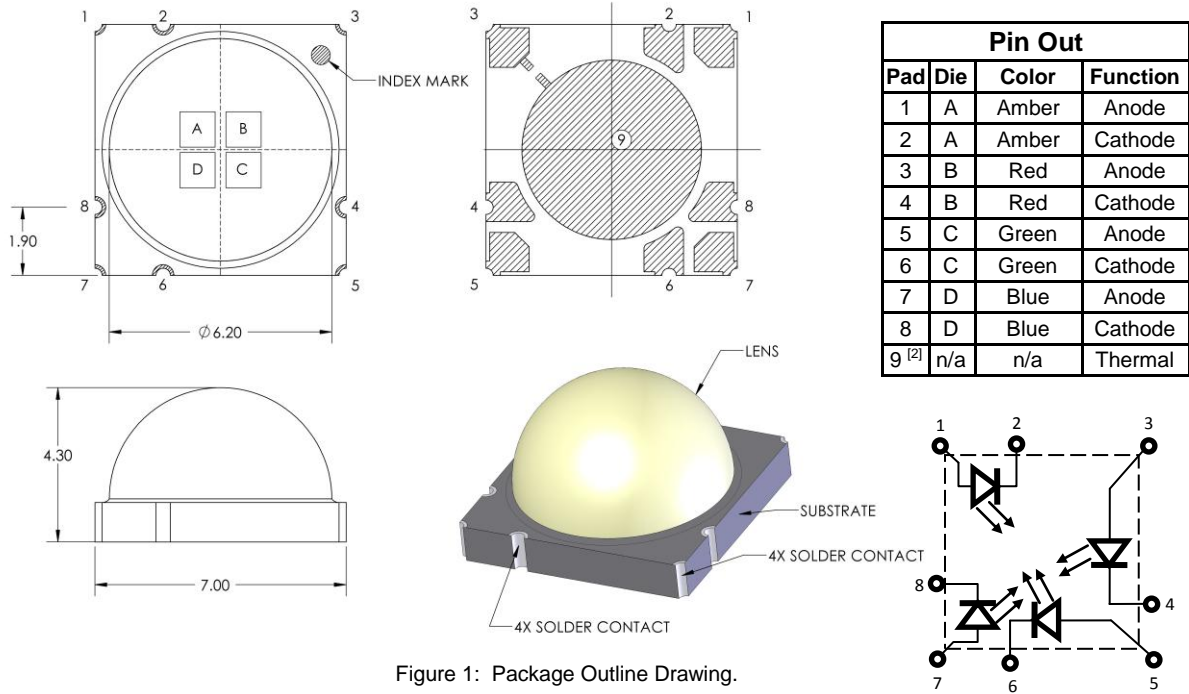

Figure 1: Package Outline Drawing.

Notes for Figure 1:

1. Unless otherwise noted, the tolerance = ± 0.20 mm.
2. Thermal contact, Pad 9, is electrically neutral.

Recommended Solder Pad Layout (mm)

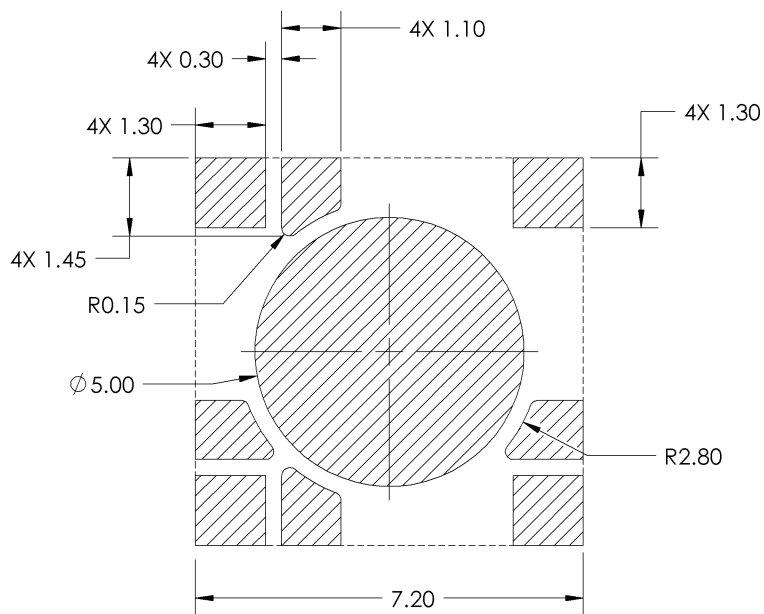

Figure 2: Recommended solder mask opening (hatched area) for anode, cathode, and thermal pad.

Note for Figure 2:

1. Unless otherwise noted, the tolerance = ± 0.20 mm.

Reflow Soldering Profile

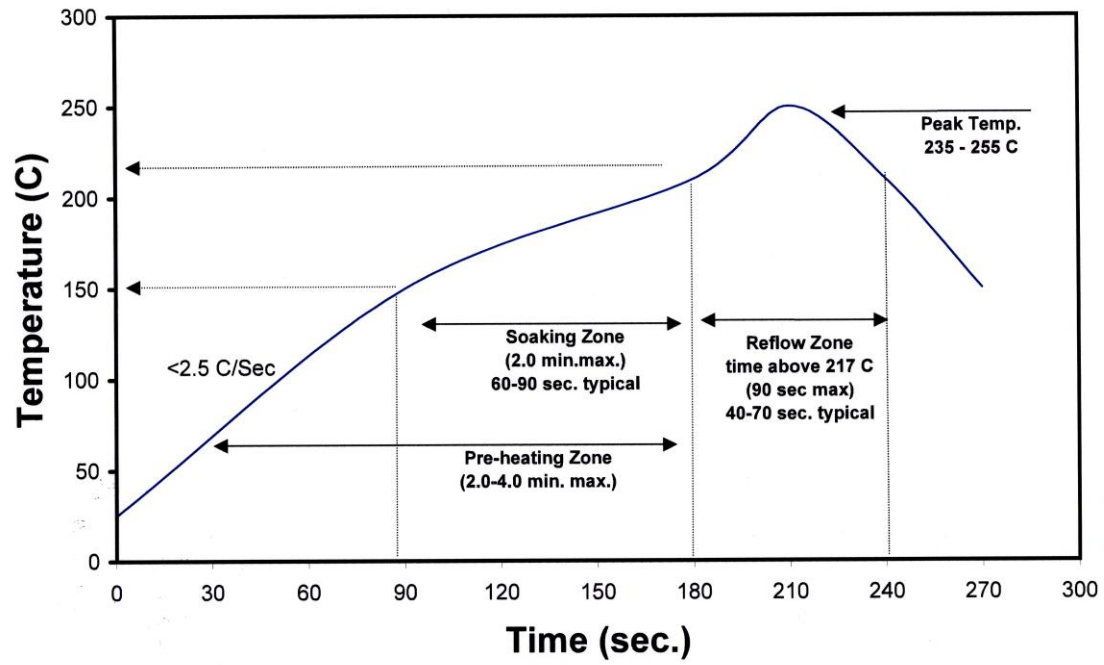

Figure 3: Reflow soldering profile for lead free soldering.

Typical Radiation Pattern

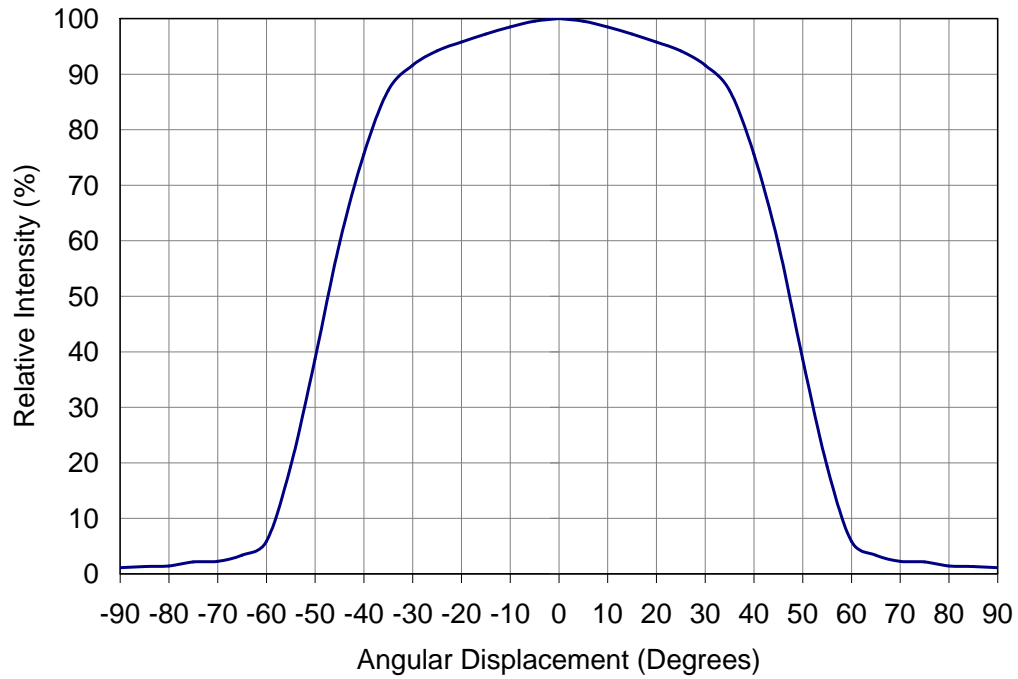

Figure 4: Typical representative spatial radiation pattern.

Typical Relative Spectral Power Distribution

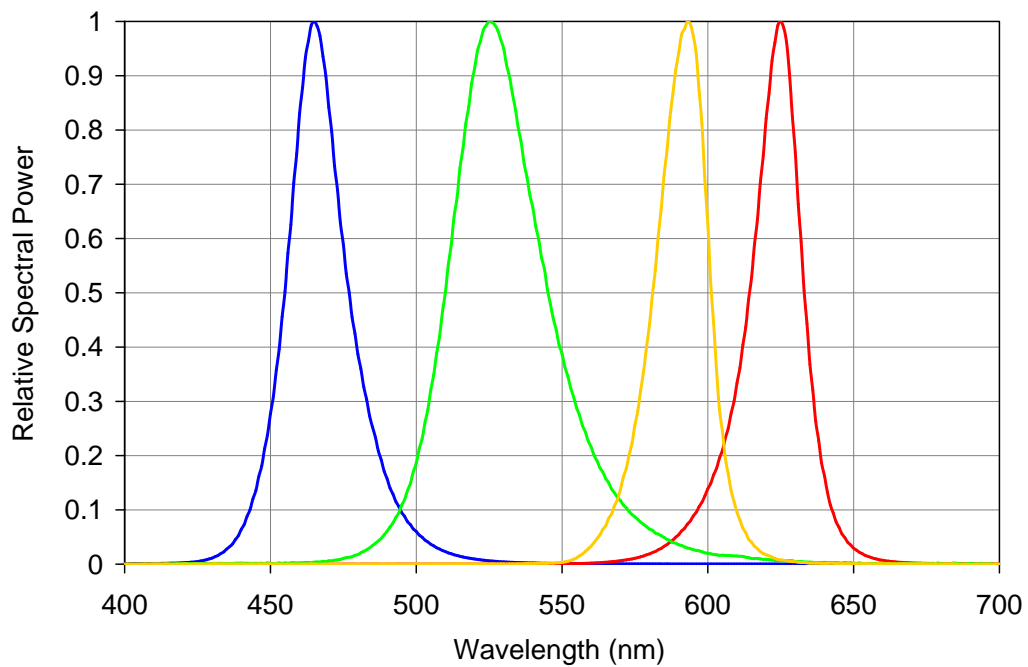

Figure 5: Typical relative spectral power vs. wavelength @ $T_c = 25^\circ\text{C}$.

Typical Dominant Wavelength Shift (REVISED NOV09)

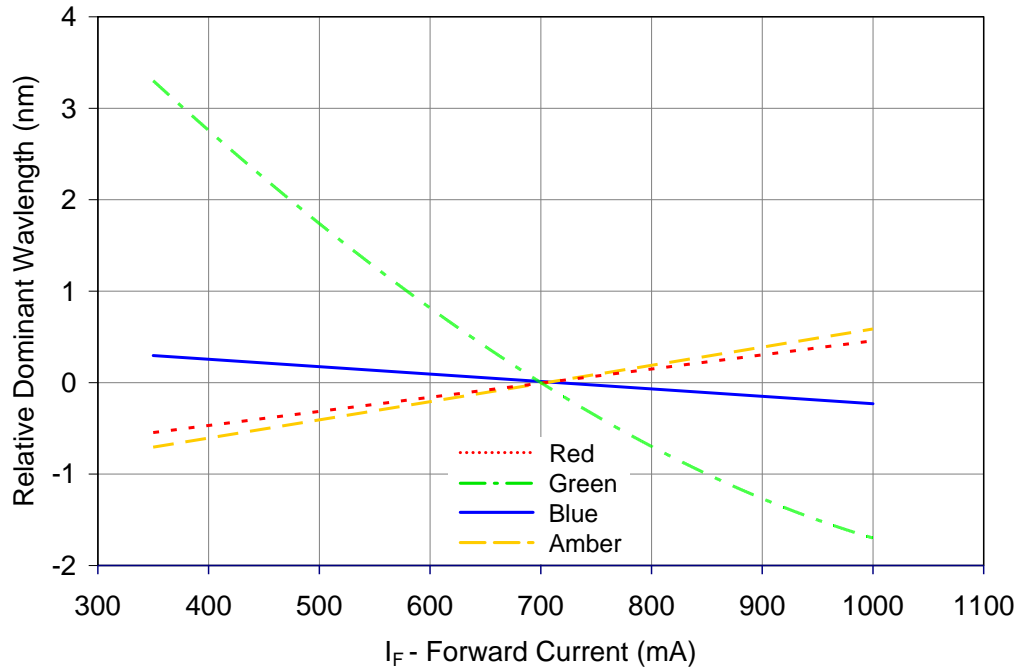

Figure 6: Typical dominant wavelength shift vs. forward current @ $T_c = 25^\circ\text{C}$.

Dominant Wavelength Shift over Temperature (REVISED DEC09)

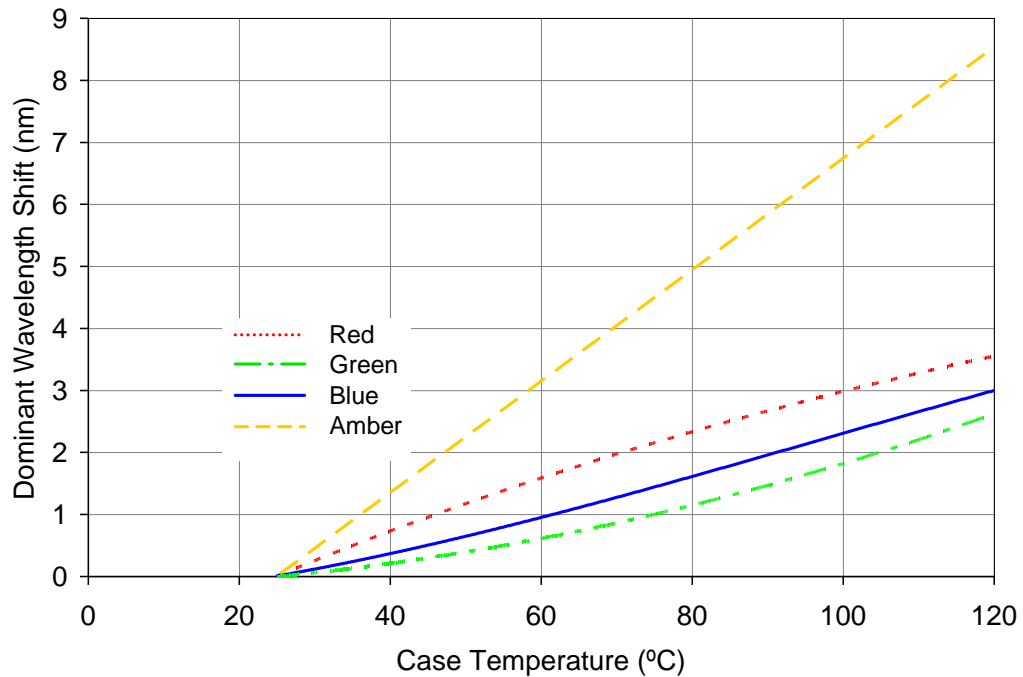

Figure 7: Typical dominant wavelength shift vs. case temperature.

Typical Relative Light Output (REVISED NOV 09)

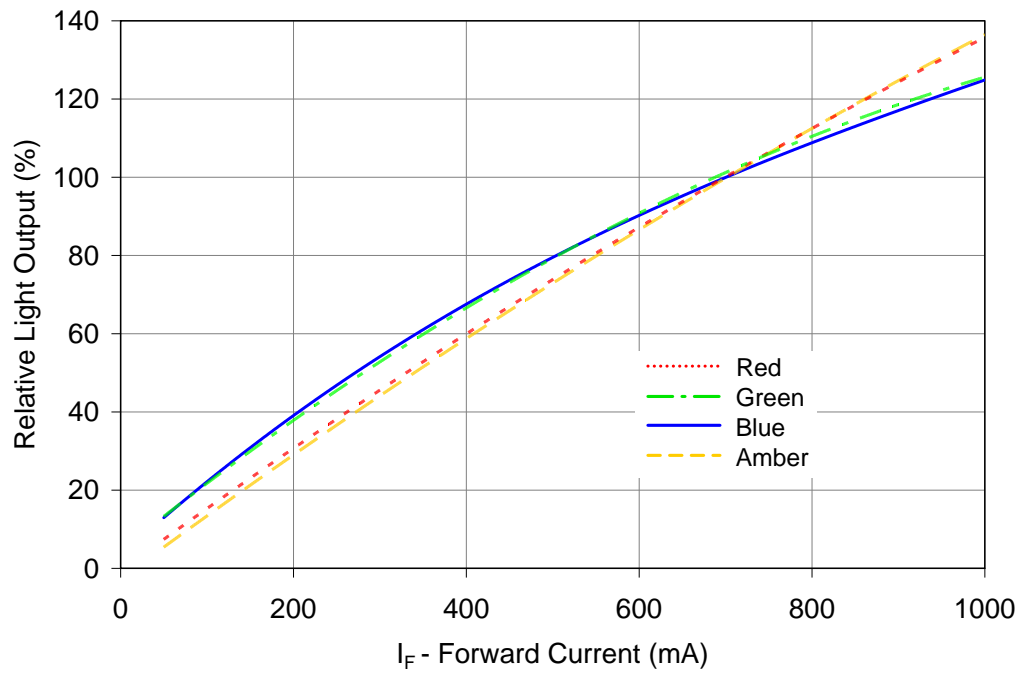

Figure 8: Typical relative light output vs. forward current @ T_c = 25°C.

Typical Relative Light Output over Temperature (REVISED DEC09)

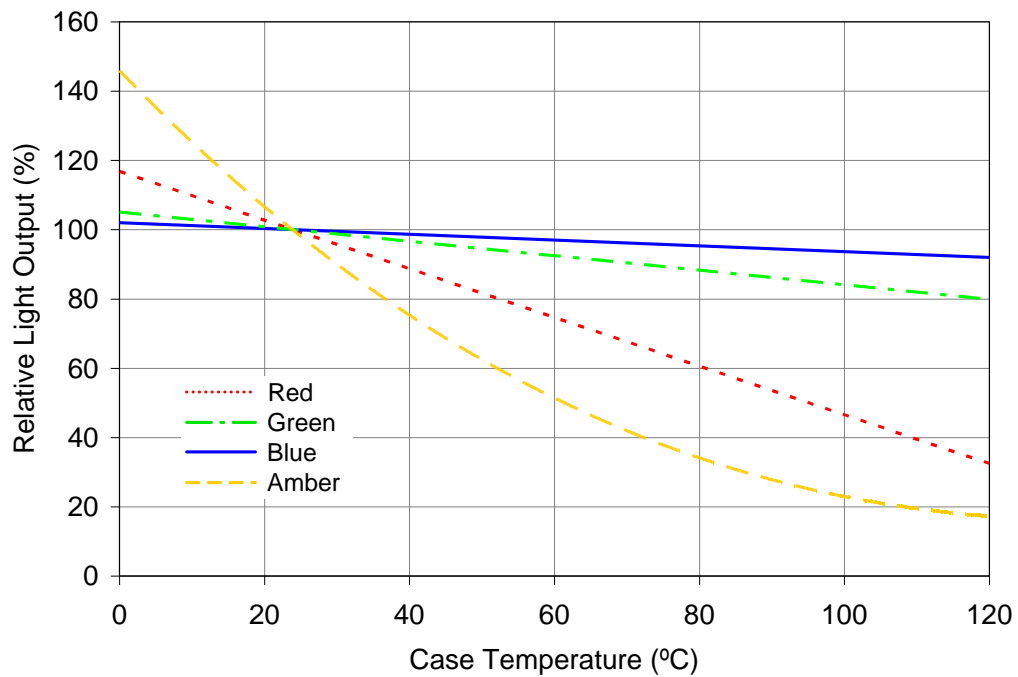

Figure 9: Typical relative light output vs. case temperature.

Typical Forward Current Characteristics (REVISED DEC09)

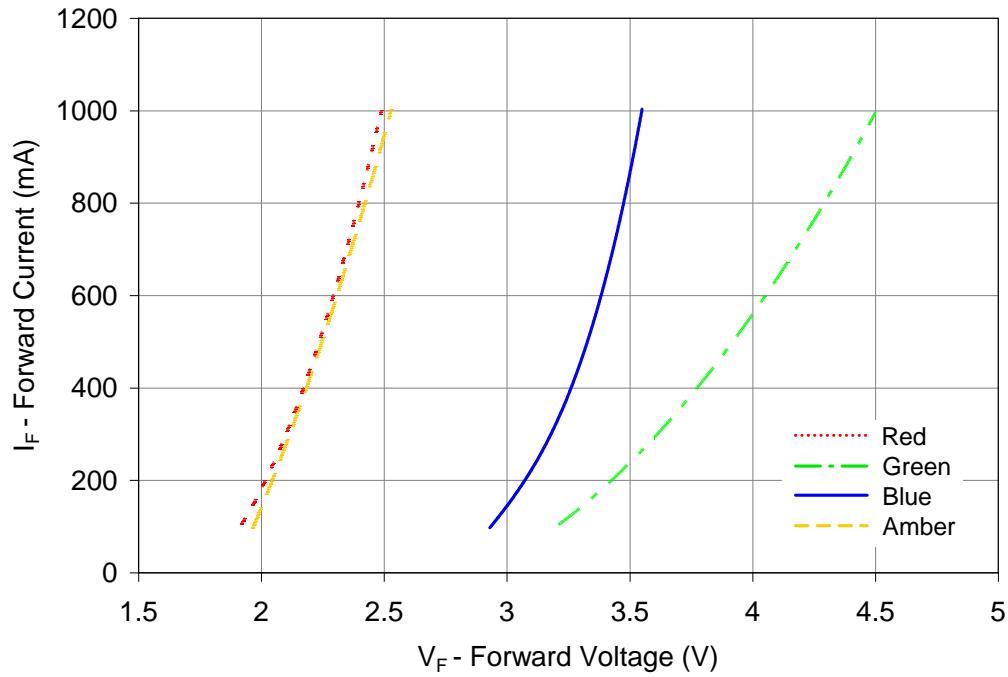

Figure 10: Typical forward current vs. forward voltage @ $T_C = 25^\circ\text{C}$.

Current Derating

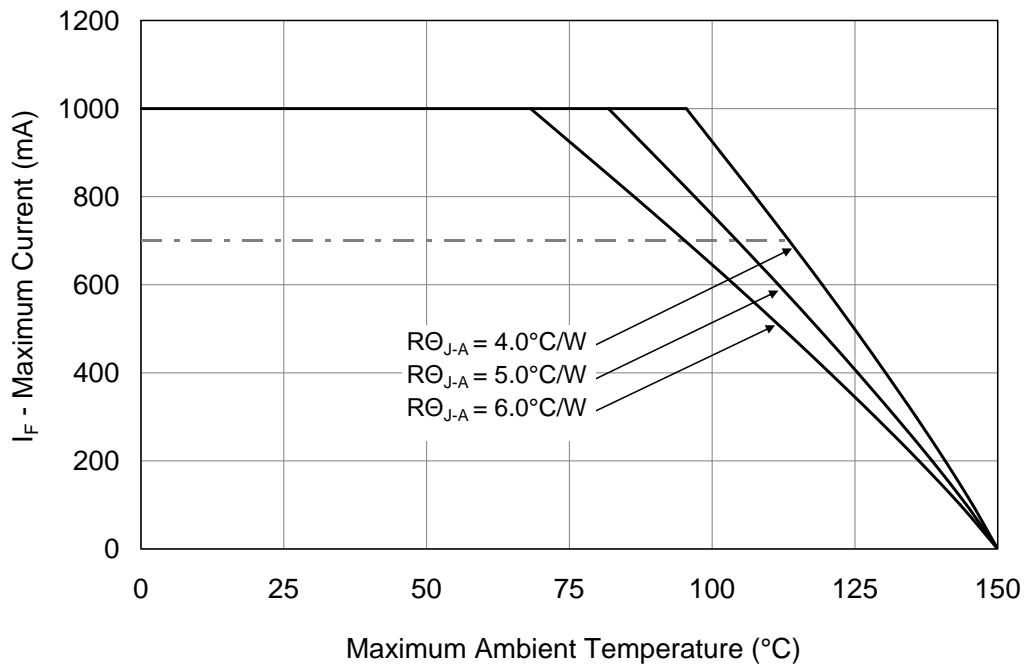

Figure 11: Maximum forward current vs. ambient temperature based on $T_{J(\text{MAX})} = 150^\circ\text{C}$.

Notes for Figure 11:

1. Maximum current assumes that all four LED dice are operating concurrently at the same current.
2. $R_{\theta_{J-C}}$ [Junction to Case Thermal Resistance] for the LZ4-00MA10 is typically 1.8°C/W .
3. $R_{\theta_{J-A}}$ [Junction to Ambient Thermal Resistance] = $R_{\theta_{J-C}} + R_{\theta_{C-A}}$ [Case to Ambient Thermal Resistance].

Emitter Tape and Reel Specifications (mm)

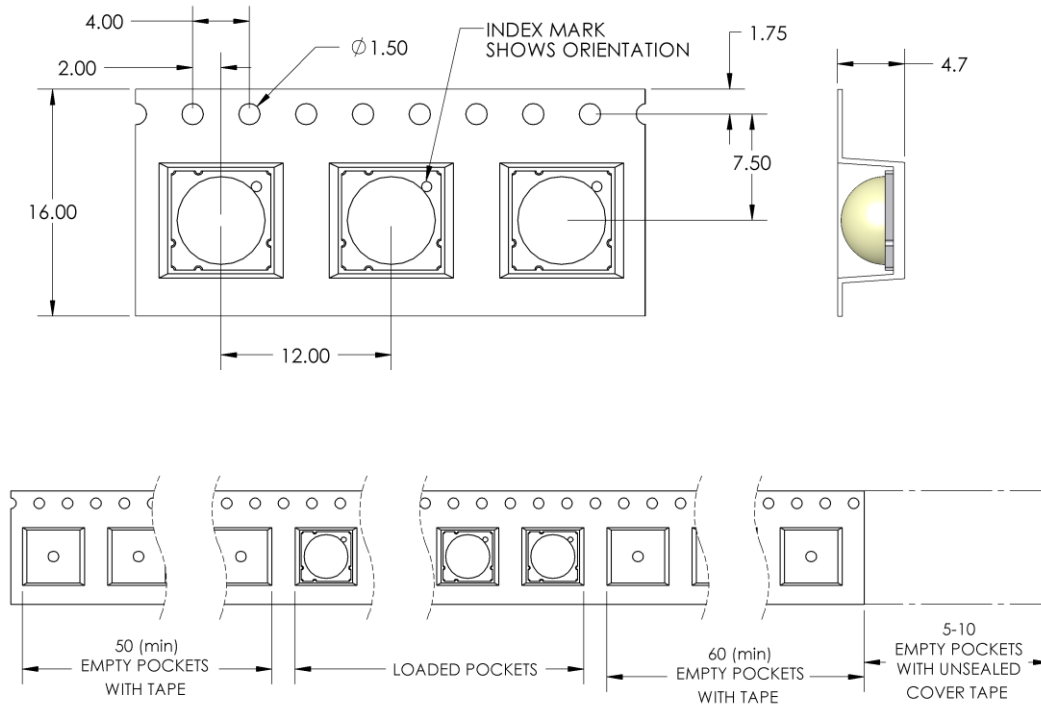

Figure 12: Emitter carrier tape specifications (mm).

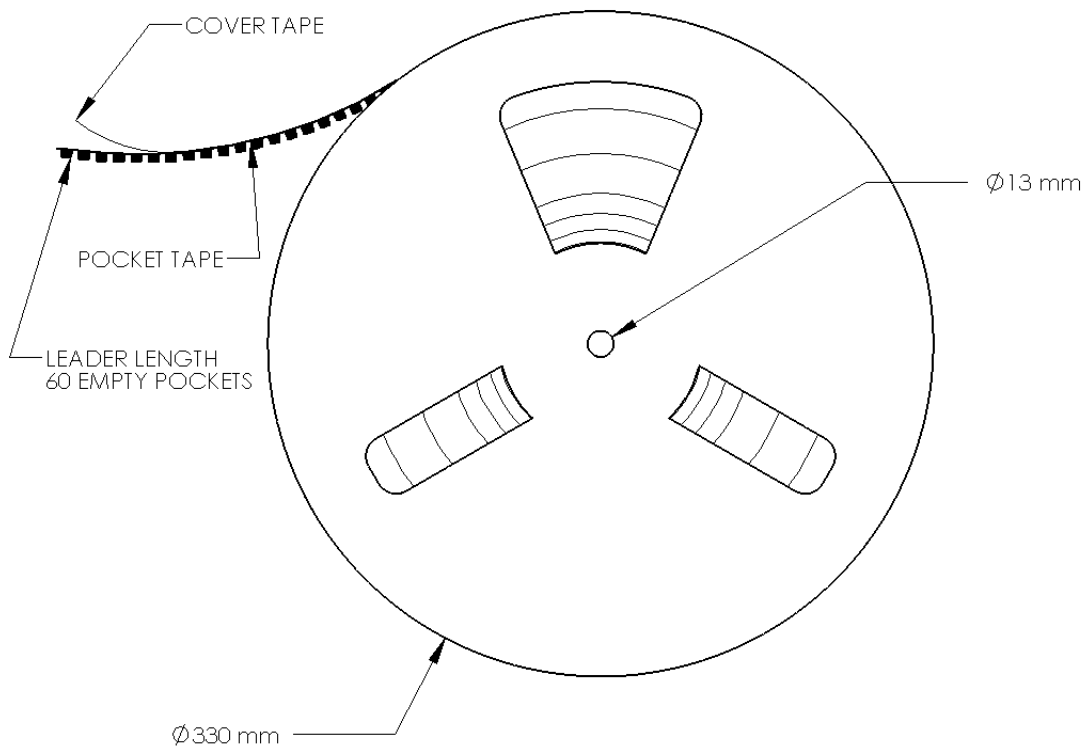

Figure 13: Emitter reel specifications (mm).

Company Information

LedEngin, Inc. is a Silicon Valley based solid-state lighting company specializing in the development and manufacturing of unprecedented high-power LED emitters, modules and replacement lamps. LedEngin's packaging technologies lead the industry with products that feature lowest thermal resistance, highest flux density and consummate reliability, enabling compact and efficient solid state lighting solutions.

LedEngin's LED emitters range from 3W to 90W with ultra-compact footprints and are available in single color products including Cool White, Neutral White, Warm White, Red, Green, Blue, Amber, Deep Red, Far Red, Dental Blue and UV as well as multi-color products with RGB, RGBA and RGBW options. LedEngin's brightest White LEDs are capable of emitting 5,000 lumens.

LedEngin's robust emitters are at the core of its unique line of modules and replacement lamps producing unmatched beam quality resulting in true Lux on Target™ for a wide variety of spot and narrow flood directional lighting applications.

LedEngin is committed to providing products that conserve natural resources and reduce greenhouse emissions.

LedEngin reserves the right to make changes to improve performance without notice.

Please contact Sales@ledengin.com or (408) 492-0620 for more information.

Mouser Electronics

Authorized Distributor

Click to View Pricing, Inventory, Delivery & Lifecycle Information:

[LED Engin:](#)

[LZ4-20MA10](#) [LZ4-00MA10](#)