

AA4040QBS/D-AMT

4.0 x 4.0 mm Right Angle Surface Mount LED Lamp

DESCRIPTIONS

- The Blue source color devices are made with InGaN Light Emitting Diode
- Electrostatic discharge and power surge could damage the LEDs
- It is recommended to use a wrist band or anti-electrostatic glove when handling the LEDs
- All devices, equipments and machineries must be electrically grounded

FEATURES

- Single color
- Suitable for all SMD assembly and solder process
- Available on tape and reel
- Ideal for backlighting
- Package: 500 pcs / reel
- Moisture sensitivity level: 3
- Halogen-free
- RoHS compliant

APPLICATIONS

- Traffic signaling
- Backlighting (illuminated advertising , general lighting)
- Interior and exterior automotive lighting
- Substitution of micro incandescent lamps
- Reading lamps
- Signal and symbol luminaire for orientation
- Marker lights (e.g. Steps, exit ways, etc)
- Decorative and entertainment lighting
- Indoor and outdoor commercial and residential architectural lighting

ATTENTION

Observe precautions for handling electrostatic discharge sensitive devices



SELECTION GUIDE

Part Number	Emitting Color (Material)	Lens Type	Iv (mcd) @ 20mA [2]			Viewing Angle [1]
			Code.	Min.	Max.	2θ1/2
AA4040QBS/D-AMT	■ Blue (InGaN)	Water Clear	N	120	200	120°
			P	200	300	
			Q	300	400	

- Notes:
1. θ1/2 is the angle from optical centerline where the luminous intensity is 1/2 of the optical peak value.
 2. Luminous intensity / luminous flux: +/-15%.
 3. Luminous intensity value is traceable to CIE127-2007 standards.
 4. LEDs will be provided from the listed bin codes. The bins delivered to the customer will be at Kingbright's discretion.

PACKAGE DIMENSIONS

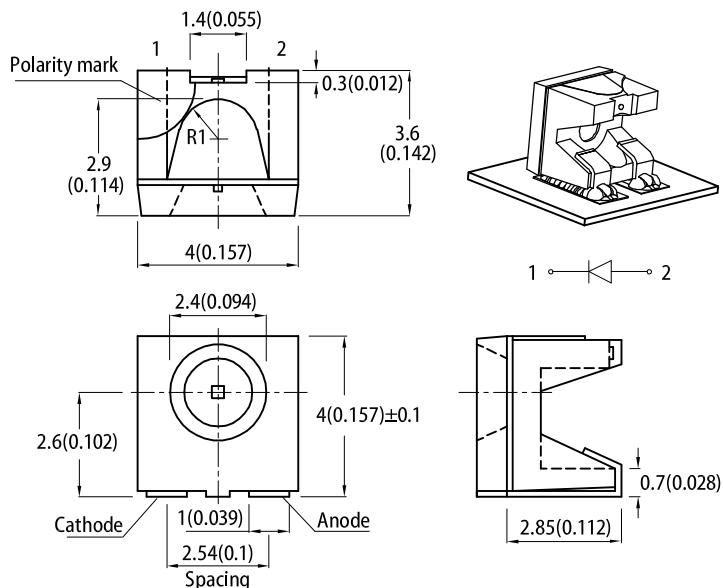

RECOMMENDED SOLDERING PATTERN

(units : mm; tolerance : ± 0.1)

Pad design for improved heat dissipation

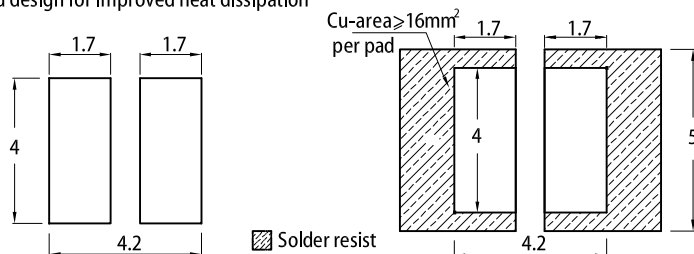

- Notes:
1. All dimensions are in millimeters (inches).
 2. Tolerance is ±0.25(0.01") unless otherwise noted.
 3. The specifications, characteristics and technical data described in the datasheet are subject to change without prior notice.
 4. The device has a single mounting surface. The device must be mounted according to the specifications.

ELECTRICAL / OPTICAL CHARACTERISTICS at $T_A=25^\circ\text{C}$

Parameter	Symbol	Emitting Color	Value				Unit
			Code.	Min.	Typ.	Max.	
Wavelength at Peak Emission $I_F = 20\text{mA}$	λ_{peak}	Blue	-	-	460	-	nm
Dominant Wavelength $I_F = 20\text{mA}$	$\lambda_{\text{dom}}^{[1]}$	Blue	1A	460	-	463	nm
			1B	463	-	466	
			2A	466	-	469	
			2B	469	-	471	
			3A	471	-	473	
			3B	473	-	475	
Spectral Bandwidth at 50% Φ REL MAX $I_F = 20\text{mA}$	$\Delta\lambda$	Blue	-	-	25	-	nm
Capacitance	C	Blue	-	-	100	-	pF
Forward Voltage $I_F = 20\text{mA}$	$V_F^{[2]}$	Blue	-	-	3.3	4.0	V
Reverse Current ($V_R = 5\text{V}$)	I_R	Blue	-	-	-	50	μA
Temperature Coefficient of λ_{peak} $I_F = 20\text{mA}$, $-10^\circ\text{C} \leq T \leq 100^\circ\text{C}$	$\text{TC}_{\lambda_{\text{peak}}}$	Blue	-	-	0.04	-	$\text{nm}/^\circ\text{C}$
Temperature Coefficient of λ_{dom} $I_F = 20\text{mA}$, $-10^\circ\text{C} \leq T \leq 100^\circ\text{C}$	$\text{TC}_{\lambda_{\text{dom}}}$	Blue	-	-	0.03	-	$\text{nm}/^\circ\text{C}$
Temperature Coefficient of V_F $I_F = 20\text{mA}$, $-10^\circ\text{C} \leq T \leq 100^\circ\text{C}$	TC_V	Blue	-	-	-2.9	-	$\text{mV}/^\circ\text{C}$

Notes:

1. The dominant wavelength (λ_d) above is the setup value of the sorting machine. (Tolerance $\lambda_d : \pm 1\text{nm}$.)
2. Forward voltage: $\pm 0.1\text{V}$.
3. Wavelength value is traceable to CIE127-2007 standards.
4. Excess driving current and / or operating temperature higher than recommended conditions may result in severe light degradation or premature failure.
5. LEDs will be provided from the listed bin codes. The bins delivered to the customer will be at Kingbright's discretion.

ABSOLUTE MAXIMUM RATINGS at $T_A=25^\circ\text{C}$

Parameter	Symbol	Value	Unit
Power Dissipation	P_D	80	mW
Reverse Voltage	V_R	5	V
Junction Temperature	T_j	115	$^\circ\text{C}$
Operating Temperature	T_{op}	-40 to +100	$^\circ\text{C}$
Storage Temperature	T_{stg}	-40 to +110	$^\circ\text{C}$
DC Forward Current	I_F	20	mA
Peak Forward Current	$I_{\text{FM}}^{[1]}$	100	mA
Electrostatic Discharge Threshold (HBM)	-	250	V
Thermal Resistance (Junction / Ambient)	$R_{\text{th JA}}^{[2]}$	450	$^\circ\text{C}/\text{W}$
Thermal Resistance (Junction / Solder point)	$R_{\text{th JS}}^{[2]}$	300	$^\circ\text{C}/\text{W}$

Notes:

1. 1/10 Duty Cycle, 0.1ms Pulse Width.
2. $R_{\text{th JA}}$, $R_{\text{th JS}}$ Results from mounting on PC board FR4 (pad size $\geq 16\text{mm}^2$ per pad).
3. Relative humidity levels maintained between 40% and 60% in production area are recommended to avoid the build-up of static electricity – Ref JEDEC/JESD625-A and JEDEC/J-STD-033.

TECHNICAL DATA

RELATIVE INTENSITY vs. WAVELENGTH

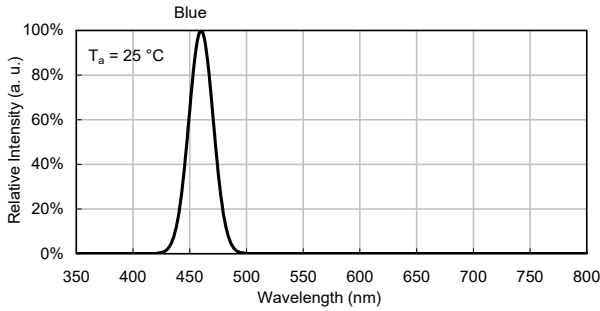

SPATIAL DISTRIBUTION

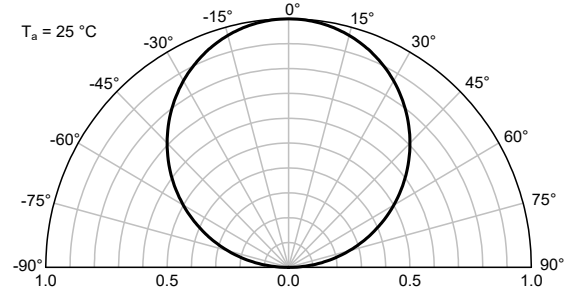

BLUE

Forward Current vs. Forward Voltage

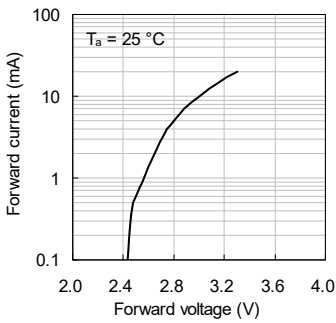

Luminous Intensity vs. Forward Current

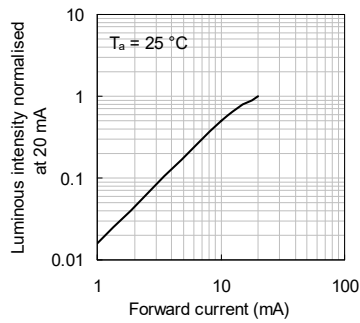

Forward Current Derating Curve

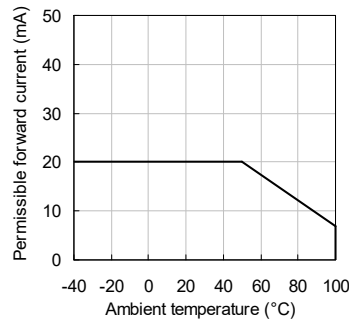

Luminous Intensity vs. Ambient Temperature

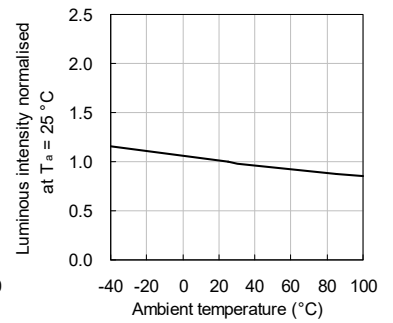

REFLOW SOLDERING PROFILE for LEAD-FREE SMD PROCESS

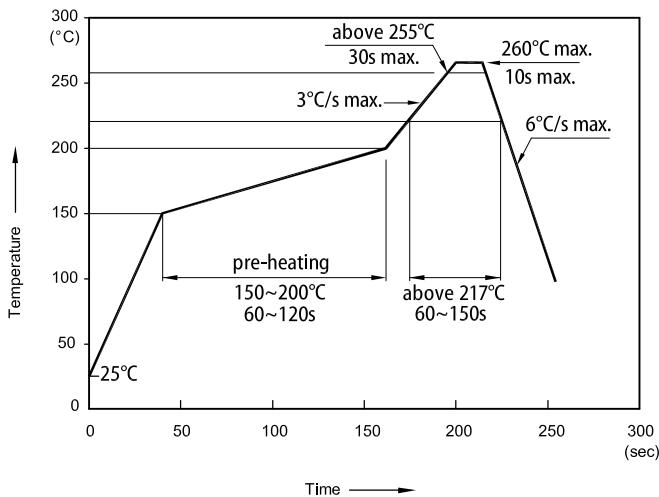

- Notes:
1. Don't cause stress to the LEDs while it is exposed to high temperature.
 2. The maximum number of reflow soldering passes is 2 times.
 3. Reflow soldering is recommended. Other soldering methods are not recommended as they might cause damage to the product.

TAPE SPECIFICATIONS (units : mm)

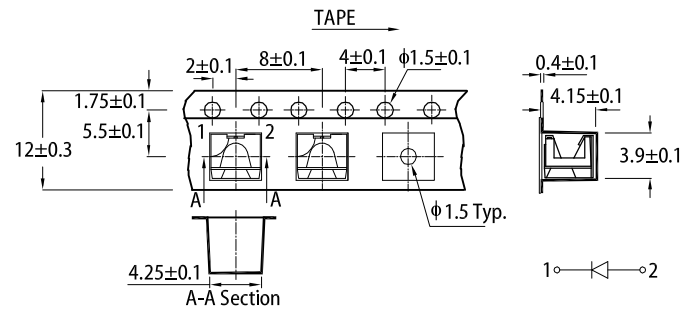

REEL DIMENSION (units : mm)

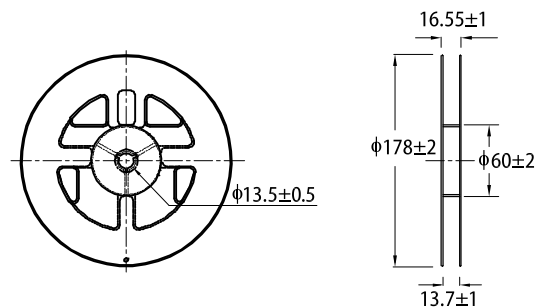

RELIABILITY TEST ITEMS AND CONDITIONS

The reliability of products shall be satisfied with items listed below

LOT TOLERANCE PERCENT DEFECTIVE (LTPD): 10%

No.	Test Item	Standards	Test Condition	Test Times / Cycles	Number of Damaged
1	Continuous operating test	-	$T_a = 25^{\circ}\text{C}$, $I_F = \text{maximum rated current}^*$	1,000 h	0 / 22
2	High Temp. operating test	EIAJ ED-4701/100(101)	$T_a = 100^{\circ}\text{C}$, $I_F = \text{maximum rated current}^*$	1,000 h	0 / 22
3	Low Temp. operating test	-	$T_a = -40^{\circ}\text{C}$, $I_F = \text{maximum rated current}^*$	1,000 h	0 / 22
4	High temp. storage test	EIAJ ED-4701/100(201)	$T_a = \text{maximum rated storage temperature}$	1,000 h	0 / 22
5	Low temp. storage test	EIAJ ED-4701/100(202)	$T_a = -40^{\circ}\text{C}$	1,000 h	0 / 22
6	High temp. & humidity storage test	-	$T_a = 60^{\circ}\text{C}$, RH = 90%	500 h	0 / 22
7	High temp. & humidity operating test	-	$T_a = 60^{\circ}\text{C}$, RH = 90% $I_F = \text{maximum rated current}^*$	500 h	0 / 22
8	Soldering reliability test	EIAJ ED-4701/100(301)	Moisture soak: 30°C , 70% RH, 72h Preheat: $150\sim 180^{\circ}\text{C}$ (120s max.) Soldering temp: 260°C (10s)	2 times	0 / 18
9	Thermal shock operating test	-	$T_a = -40^{\circ}\text{C}$ (15min) ~ 100°C (15min) $I_F = \text{derated current at } 100^{\circ}\text{C}$	1,000 cycles	0 / 22
10	Thermal shock test	-	$T_a = -40^{\circ}\text{C}$ (15min) ~ maximum rated storage temperature(15min)	1,000 cycles	0 / 22
11	Electric Static Discharge (ESD)	EIAJ ED-4701/100(304)	$C = 100\text{pF}$, $R_2 = 1.5\text{K}\Omega$ $V = 250\text{V}$	Once each Polarity	0 / 22
12	Vibration test	-	$a = 196\text{m/s}^2$, $f = 100\sim 2\text{KHz}$, $t = 48\text{min}$ for all xyz axes	4 times	0 / 22

* : Refer to forward current vs. derating curve diagram

CRITERIA FOR JUDGING DAMAGE

Items	Symbols	Conditions	Failure Criteria
luminous Intensity	I_V	$I_F = 20\text{mA}$	Testing Min. Value < Spec. Min. Value x 0.5
Forward Voltage	V_F	$I_F = 20\text{mA}$	Testing Max. Value \geq Spec. Max. Value x 1.2
Reverse Current	I_R	$V_R = \text{Maximum Rated Reverse Voltage}$	Testing Max. Value \geq Spec. Max. Value x 2.5
High temp. storage test	-	-	Occurrence of notable decoloration, deformation and cracking

PACKING & LABEL SPECIFICATIONS

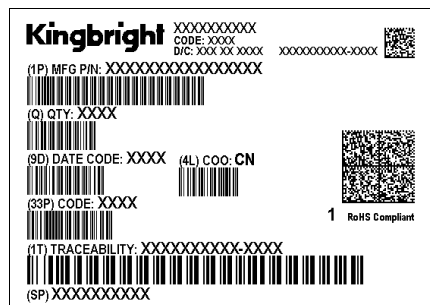
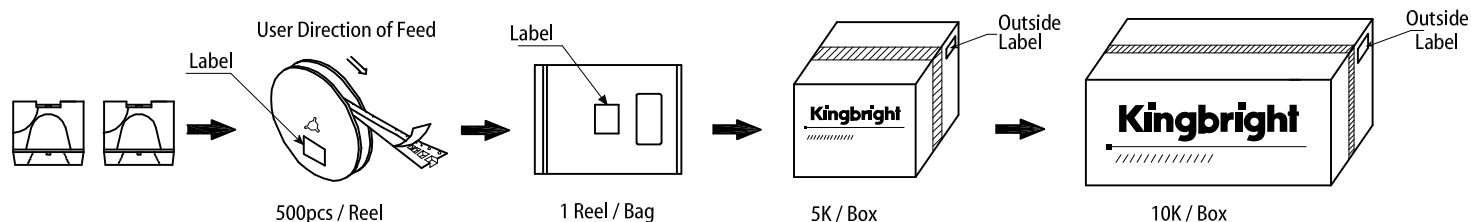

HANDLING PRECAUTIONS

Compare to epoxy encapsulant that is hard and brittle, silicone is softer and flexible. Although its characteristic significantly reduces thermal stress, it is more susceptible to damage by external mechanical force. As a result, special handling precautions need to be observed during assembly using silicone encapsulated LED products. Failure to comply might lead to damage and premature failure of the LED.

1. Handle the component along the side surfaces by using forceps or appropriate tools.
2. Do not directly touch or handle the silicone lens surface. It may damage the internal circuitry.

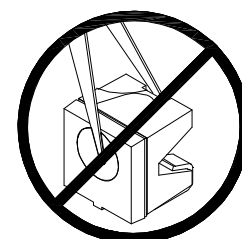
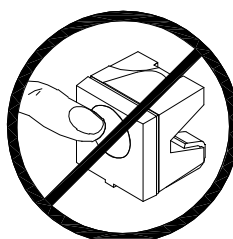
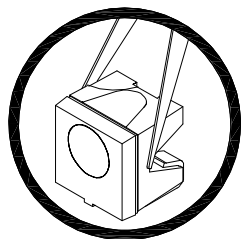

3. As silicone encapsulation is permeable to gases, some corrosive substances such as H₂S might corrode silver plating of lead frame. Special care should be taken if an LED with silicone encapsulation is to be used near such substances.

PRECAUTIONARY NOTES

1. The information included in this document reflects representative usage scenarios and is intended for technical reference only.
2. The part number, type, and specifications mentioned in this document are subject to future change and improvement without notice. Before production usage customer should refer to the latest datasheet for the updated specifications.
3. When using the products referenced in this document, please make sure the product is being operated within the environmental and electrical limits specified in the datasheet. If customer usage exceeds the specified limits, Kingbright will not be responsible for any subsequent issues.
4. The information in this document applies to typical usage in consumer electronics applications. If customer's application has special reliability requirements or have life-threatening liabilities, such as automotive or medical usage, please consult with Kingbright representative for further assistance.
5. The contents and information of this document may not be reproduced or re-transmitted without permission by Kingbright.
6. All design applications should refer to Kingbright application notes available at <https://www.KingbrightUSA.com/ApplicationNotes>

Mouser Electronics

Authorized Distributor

Click to View Pricing, Inventory, Delivery & Lifecycle Information:

[Kingbright:](#)

[AA4040QBS/D-AMT](#)