

THIS DOCUMENT IS THE PROPERTY OF  
KEYSTONE ELECTRONICS CORP. AND  
SHALL NOT BE REPRODUCED, DISTRIBUTED  
OR USED AS A BASIS FOR MANUFACTURE  
WITHOUT PRIOR WRITTEN PERMISSION  
FROM KEYSTONE ELECTRONICS CORP.

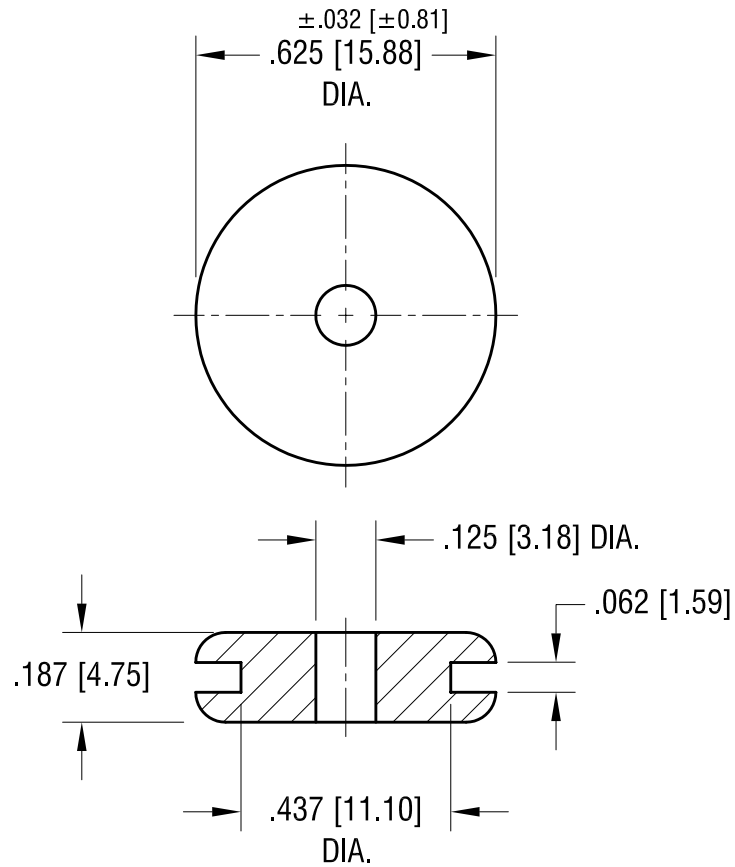

**KEYSTONE ELECTRONICS CORP.**

ASTORIA, N.Y. 11105-2017

PART NAME

RUBBER GROMMET

MATERIAL

BUNA N

FINISH

-

DRN BY

BOONE

DATE

10.10.97

APP'D

LN

SCALE

2.5X

1.02.08

CHANGE AS PER ECN 08-012

A

TOLERANCES

INCH [MM]

DECIMAL  $\pm .020$  [ $\pm 0.50$ ]

ANGULAR  $\pm 1^\circ$   
UNLESS OTHERWISE SPECIFIED

CODE

C/M

DWG NO.

734

DATE

DESCRIPTION

REV.

# Mouser Electronics

Authorized Distributor

Click to View Pricing, Inventory, Delivery & Lifecycle Information:

[Keystone Electronics:](#)

[734](#)